

STRUCTURES OF SOME SILICATES

JOHN W. GRUNER, *University of Minnesota.*

INTRODUCTION

Since 1926 a large number of structures of silicates have been investigated. Though W. L. Bragg (37) has published a long paper recently on the progress of this work it may not be amiss to review his work in this journal and include in addition those structures which have been determined in the last eighteen months. It is not the intention of the writer to show projections of these structures. In the first place, they are so complicated that photographs of models or perspective drawings do not convey the proper conceptions. Secondly, they might be too technical for the reader who has not specialized in this type of study. Instead of showing such projections, an attempt will be made to develop structural diagrams which will give the student the proper conception of the structural combinations so far encountered in the silicates. Acknowledgment of the sources from which the writer has drawn is made in the bibliography. The references are necessarily limited to the latest complete *x*-ray studies of the silicates. For additional references the reader will find it necessary to consult each original investigation.

VALENCY AND COORDINATES

Two years ago the writer reviewed the literature of a number of simple type structures in this journal (38) and showed how each atom or ion—the silicates are most probably built up of ions—tries to surround itself with ions of opposite charge in such a manner that all bring their maximum influence to bear on one another. We might say that their spheres of influence are in contact. The radii of these spheres are significant but more important are the ratios of the radii of the cations to those of the anions which surround them. In the common silicates the cations are usually smaller than the most abundant anion O. Table I lists the radii of the most important ions in silicates. The cation of Si is so small that it just fits into the void between four anions of O which are in contact in such a fashion that their centers are at the corners of a regular tetrahedron whose edge is 2.6–2.7 Å in length. (Fig. 1, a.) The group SiO₄ thus formed is the foundation of all investigated silicate structures including quartz and other SiO₂ modifications. The SiO₄ tetrahedra may be slightly distorted but as a whole they are the most

regular and reliable building units of the silicates. Si in an SiO_4 group has four valency coordinates (38) linking Si to four O. The SiO_4 group has four excess negative charges by which it is linked to neighboring cations. These may be Si or other elements.

TABLE I. EFFECTIVE RADII OF IONS OF SOME OF THE ELEMENTS IN SILICATES

Be^{++}	0.34 Å	Ca^{++}	1.06 Å
Si^{++++}	0.39	Sr^{++}	1.27
Al^{+++}	0.57	K^+	1.33
Ti^{++++}	0.64	Ba^{++}	1.43
Fe^{+++}	0.67	O^{--}	1.32
Mn^{+++}	0.70?	F^-	1.33
Mg^{++}	0.78	$(\text{OH})^-$	1.4-1.5
Li^+	0.78	S^{--}	1.74
Fe^{++}	0.83	Cl^-	1.81
Zn^{++}	0.83		
Sc^{+++}	0.83		
Zr^{++++}	0.87		
Mn^{++}	0.91		
Na^+	0.98		

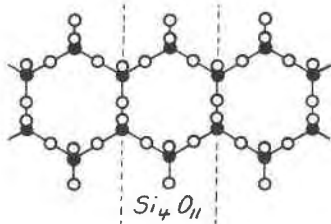
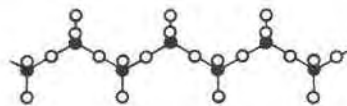
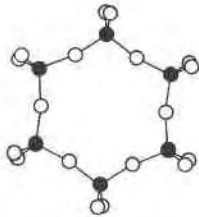
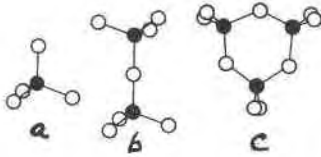

FIG. 1. (a) SiO_4 group; (b) Si_2O_7 group; (c) Si_3O_9 group (benitoite ring). After W. L. Bragg.

FIG. 2. Si_6O_{18} group (beryl ring).

FIG. 3. SiO_3 endless chain in pyroxenes.

FIG. 4. Si_4O_{11} endless chain in amphiboles.

In orthosilicates, SiO_4 groups are never in direct contact with one another. This arrangement had been suspected long ago. There had also been vague predictions of certain linkages of SiO_4 groups, some of which have lately been shown to exist. How two SiO_4 tetra-

hedra may have one corner in common forming an Si_2O_7 group is shown in Fig. 1,b. This grouping exists in the melilite silicates. Fig. 1,c shows a linking of three SiO_4 groups giving one large Si_3O_9 aggregate as found in benitoite. A ring of six SiO_4 tetrahedra (Fig. 2) resulting in an Si_6O_{18} group has been discovered in beryl.

Still more interesting are the endless chains of SiO_4 groups. Single chains (Fig. 3) exist in the pyroxenes (8). Due to this linking of the tetrahedra the ratio of Si:O becomes 1:3, which is that of the metasilicates. The discovery by Warren (15) of endless double chains (Fig. 4) in the amphiboles has added much to the understanding of these complex structures. The unit Si_4O_{11} occurs in them as will be shown later. Endless sheets of SiO_4 groups in which three of the four tetrahedral corners of each SiO_4 group are linked to adjoining SiO_4 groups are shown in Fig. 5. They give rise to Si_4O_{10} units as in the micas and talc. Another complex type of SiO_4 grouping is the feldspar type first predicted by Machatski (14). It consists of frameworks of SiO_4 groups. (Fig. 6.) Each tetrahedron shares its four corners with four adjacent SiO_4 tetrahedra resulting in a ratio 1:2 for Si to O.

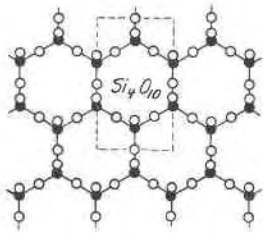

FIG. 5. Si_4O_{10} endless sheet in micas.

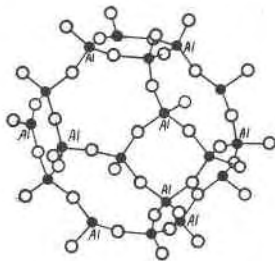

FIG. 6. $\text{Si}_6\text{Al}_6\text{O}_{24}$ framework in sodalite, after Jaeger.

Cations other than Si may have four or more valency coordinates. Their coordinate number seems to depend less on chemical valency than on their sizes and more complicated factors, some of them little understood. Aluminum may be the center of a tetrahedral AlO_4 group which strongly resembles the SiO_4 group. It is, however, slightly larger and more distorted on account of the larger size of the Al cation. Aluminum frequently is the center of a somewhat distorted octahedron in which position it has a valency of six valency coordinates to the six corners of the octahedron. These corners are the centers of O, F, or OH anions as a rule. The be-

havior of Al shows that an element may have more than one coordinate number even in the same structure as will be shown in andalusite, for example, in which half of the Al ions have the coordinate number 5, the other half the number 6. Mg, Fe^{II} and Na usually behave like Al with six coordinates, while Ca more often has eight coordinates. Beryllium on the other hand, is at the center of a tetrahedron like Si. Boron behaves the same way though it may have only three coordinates. The reader may have noticed that as a general rule the larger cations have the larger number of valency coordinates. This is a natural consequence of the empirical law stated earlier that each cation tries to gather as many anions about itself as will closely fit around it.

Notwithstanding the fact that in crystals an ion with a certain chemical valency may be replaced by one with a different valency, the total positive and negative valencies must balance in any stable structure. Pauling has gone farther and has proposed his "rule of compensation of electrostatic valency" (36) which has been found valid within certain limits for the structures investigated. It states that in a stable structure, the electric charge of each anion is approximately or exactly compensated by the strength of the electrostatic valency bonds reaching it from the cations to which it is linked directly. An example will illustrate this rule. In olivine (forsterite) each O ion is linked to one Si and three Mg ions. Si has a valency 4, and each of its four bonds has a value 1. Mg has a valency 2. Each of its six coordinates is equal to one-third of a positive charge. The two negative charges of O are compensated exactly by $(3 \times \frac{1}{3} + 1) = 2$ positive charges.

It is a curious observation that in an actual structure, places of weakness seem to occur only where the value for each bond sinks below a certain limit. Bonds with an individual valency of 1 appear to be extremely strong. The writer has been unable to find a structure in which cleavage, for example, cuts through such bonds. It seems also that three bonds of one-third valency each are not as strong as a single bond with a valency of 1. More observations will be necessary, however, before a definite statement can be made.

ISOMORPHOUS REPLACEMENT

A vast amount of work has been done on isomorphous replacements in silicates. We shall mention only those points of the subject which seem to have been definitely established as facts and

summarized by W. L. Bragg (37). There seems to be little doubt that the amount of O in a silicate is practically a constant and should be treated as such. The O ion is so large that it is improbable that additional O ions could enter a stable structure. The F ion or the OH radical, which are of about the same size as O, could possibly take its place, but it is more common for F to replace OH, or vice versa. The replacement of one cation by another is extremely common in silicates. We only need to mention the plagioclase feldspars in which Na and Si are replaced by Ca and Al, respectively. It is not possible, however, for Ca to replace Na without a corresponding substitution of Al for Si. How complicated such replacements may be is illustrated in Warren's paper on the amphiboles (16) in which a number of recast analyses are given. Mauguin's (34) investigation of the micas had shown as early as 1928 that the number of O ions in the unit cell remained practically constant. The greatest possible variation exists in micas, however, not only in the amount of substitution of one metal for another, but also in the number of metals that may replace one another. The metals which are difficult to assign in the determination of a structure are those whose cations have two different coordinate numbers. Aluminum is a typical example. It frequently takes the place of Si with four coordinates, but it may also replace Mg, Mn, Fe^{III}, Ti and Cr with six. Table I which gives the radii of common ions is helpful in this respect. An ion will replace another only if the difference between their radii is relatively small.

STRUCTURE DIAGRAMS

Many attempts at devising correct structural formulas for silicates have appeared. Actual determinations of the structures have invalidated most of them. Nothing would be gained by listing at this time even the more valuable contributions which preceded the *x*-ray study of silicates. A structural formula can indicate only a limited number of the important features of a structure. An attempt, therefore, has been made to draw diagrams which combine the advantages of structural formulas with those other features essential for an understanding of a particular structure. It is realized, of course, that the diagrams presented are not the only possible ones which can be devised.

One chemical molecule, or at the most two, have been used in each figure. Ions which are not directly linked in the actual structures are kept apart in the diagrams. Since it is impossible to sep-

arate individual molecules in the structures without having unsatisfied valencies left over, "loose" bonds are also found in the diagrams. The latter are drawn in such a way that an indefinite number of them may be linked together in the principal directions without destroying the integrity of the structures. The continuity of a structure may be represented in this manner.

For simplicity's sake, not all coordinates are drawn except where absolutely necessary. Silicon and aluminum with a coordination of 4, however, always have all coordinates shown. Magnesium and aluminum with 6 coordinates frequently will have only three bonds shown. A number of bonds are drawn as full lines, others as dotted lines. *No essential structural difference exists between these two kinds.* The number of full lines to an ion indicates the chemical valency of the ion while the dotted lines are added to complete the number of valency coordinates which can be shown advantageously in the diagrams. A new feature is introduced in the chemical formulas under the diagrams. The number of valency coordinates for each element is written above the symbol of that element. Where two numbers are given some of the ions have a different coordinate number from others of the same element. The number of diagrams which could be included was limited by the cost of the cuts involved.

STRUCTURES

ORTHO-SILICATES

In orthosilicates the ratio Si:O is 1:4 or greater. The SiO_4 tetrahedra are separated from one another by the remaining cations of

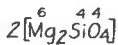
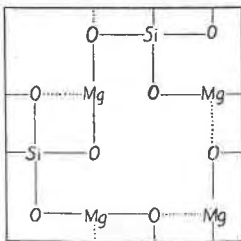

FIG. 7. Forsterite.

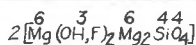
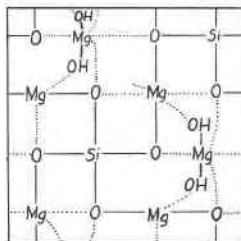

FIG. 8. Norbergite.

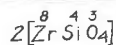
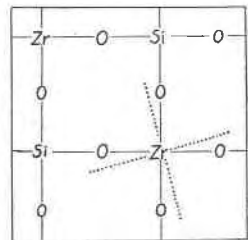

FIG. 9. Zircon.

the structure which will just neutralize the negative charges of the SiO_4 groups.

OLIVINE GROUP. (Bragg and Brown, 3). In forsterite, Mg_2SiO_4 , (Fig. 7) each SiO_4 group is surrounded by Mg ions. There are six coordinates from each Mg to six O ions at approximately equal distances. Each O has four coordinates, three to Mg and one to Si. Fe^{II} can replace Mg, of course. Monticellite ($MgCaSiO_4$) has the same structure as olivine (Brown and West, 6). Half of the Mg ions are replaced by Ca. This results in a slight shift of certain positions on account of the larger size of Ca.

CHONDRODITE GROUP.

Norbergite	$Mg(OH, F)_2Mg_2SiO_4$
Chondrodite	$Mg(OH, F)_2(Mg_2SiO_4)_2$
Humite	$Mg(OH, F)_2(Mg_2SiO_4)_3$
Clinohumite	$Mg(OH, F)_2(Mg_2SiO_4)_4$

A comparison of these four minerals (Taylor and West, 8) is very interesting. They are very similar to forsterite as may be seen in Fig. 8. If we could cut forsterite parallel to (001) into slabs of Mg_2SiO_4 units and introduce layers consisting of $Mg(OH, F)_2$ at definite intervals we would arrive at the members of the chondrodite series. In norbergite slabs of Mg_2SiO_4 alternate with slabs of $Mg(OH, F)_2$, (Fig. 8). In chondrodite a pair of slabs of Mg_2SiO_4 is always followed by a layer of $Mg(OH, F)_2$. In humite every fourth slab would be $Mg(OH, F)_2$, in clinohumite every fifth slab. No diagrams are shown for chondrodite, humite, or clinohumite. They can, however, be easily constructed by a combination of the diagrams of forsterite and chondrodite. Each Mg in this group is linked to six anions. Where the Mg is located in a slab of $Mg(OH, F)_2$ two of the six anions are (OH, F), the other four are O. Each (OH, F) is connected to three almost equidistant Mg cations.

PHENACITE. Phenacite, Be_2SiO_4 , (Bragg and Zachariasen, 7) contains BeO_4 tetrahedra besides the SiO_4 groups. Each SiO_4 group is linked to four BeO_4 groups. Fig. 7 may be used for illustrating this structure if Be is put in place of Mg. Since there exists only a single bond between each Si and Be ion, not a double bond, the missing fourth coordinates should connect with Be ions below or above the plane of the diagram. Each O has three coordinates. Willemite, Zn_2SiO_4 , has the same structure, Zn taking the place of Be.

ZIRCON. In zircon, $ZrSiO_4$, (Vegard, 1, and Wyckoff and Hendricks, 2) each Zr cation is linked to eight nearly equidistant O ion. Each O ion is tied to two Zr and one Si cations. Since each

Zr is linked to eight different tetrahedra of SiO_4 only four of the eight coordinates can be shown in Fig. 9 without destroying the simplicity of the diagram.

TITANITE. In titanite, CaTiSiO_5 , (Zachariasen, 26), each Ti ion is surrounded by six O ions at the corners of a somewhat distorted octahedron. Ca has seven coordinates to seven nearly equidistant O ions. Each O is linked to three or four cations. See Fig. 10.

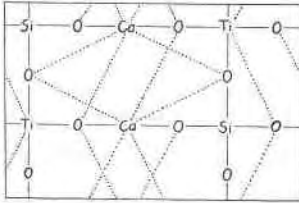

FIG. 10. Titanite.

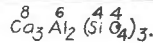
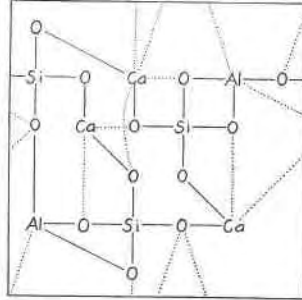

FIG. 11. Garnet (grossularite).

GARNET GROUP. It is difficult to represent the garnet structure (Menzer, 4) diagrammatically because the SiO_4 groups must be kept apart. In grossularite, $\text{Ca}_3\text{Al}_2(\text{SiO}_4)_3$ the SiO_4 groups are separated by Al and Ca (Fig. 11). Al has the coordination number 6 and Ca the number 8. The eight O ions around Ca are at the corners of a distorted cube. Each O in the structure has four coordinates, two to Ca, one to Al and one to Si.

TOPAZ. Topaz, $[\text{Al}(\text{OH},\text{F})_2\text{SiO}_4]$, also has self-contained SiO_4 groups linked together by Al ions (Pauling, 11, and Alston and West, 13). Al has six coordinates, four to O and two to (OH,F). Each (OH,F) lies between two Al but not in a straight line with

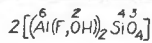
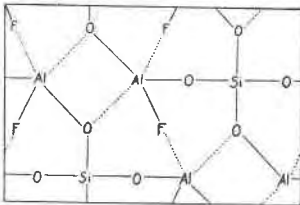

FIG. 12. Topaz.

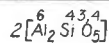
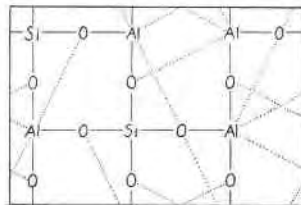

FIG. 13. Cyanite.

them. It has two coordinates while each O has three. See Fig. 12. The perfect basal cleavage in topaz seems to lie between Al,O and Al,O planes. It most probably does not cut the very strong Si-O bonds which are found everywhere in the crystal except between the two planes mentioned.

CYANITE. Cyanite, Al_2SiO_5 , (Náray-Szabó, Taylor and Jackson, 19) as well as andalusite and sillimanite have self-contained SiO_4 groups linked together by Al (Fig. 13). The Al ions in cyanite have six coordinates. The O ions have three and four coordinates connecting two Al and one Si or four Al, respectively. Half of the Al ions occur in chains parallel to the *c* axis. Parallel to the plane (100) layers of ions occur in the order: Al,O—Al,O—Si,Al,O—O—Si,Al,O and repeated. The excellent cleavage of cyanite parallel (100) probably occurs between the two Al,O layers where each O is linked to four Al and not along the O layer as proposed by Náray-Szabó, Taylor and Jackson (19). The reason for this belief will be given under staurolite in the next paragraph. Too little is known about crystal physics to explain the anomalous differences in hardness on the (100) face in cyanite.

STAUROLITE. Staurolite, $\text{Fe}(\text{OH})_2(\text{Al}_2\text{SiO}_5)_2$, may be conceived as built up of unit slabs of cyanite interlayered with slabs of $\text{Fe}(\text{OH})_2$ (Náray-Szabó, 20). The slabs of $\text{Fe}(\text{OH})_2$ are inserted in the cyanite structure between the two Al,O layers parallel to (100) along which the cleavage occurs in cyanite according to the writer's belief. This introduction of $\text{Fe}(\text{OH})_2$, therefore, destroys the cleavage for staurolite. If cleavage took place along the O layer there would be no reason why it should not be found in staurolite since the O layer is preserved in the staurolite structure. Attention is called to the different orientation of the two minerals. The (100) plane of cyanite is the (010) plane of staurolite. It is not possible to show all these features in Fig. 13.

SILLIMANITE. Sillimanite, Al_2SiO_5 , (Taylor, 10) differs from cyanite mainly with respect to the behavior of one half of the Al ions. These Al ions have four coordinates, the same as Si, resulting in AlO_4 groups. The other Al ions are arranged as in cyanite in chains and have a coordination of six (Fig. 14). Why is sillimanite fibrous in structure? The writer observed that the SiO_4 and AlO_4 groups, which are alternately linked together, form endless double chains of SiO_4 and AlO_4 tetrahedra parallel to the *c* axis (parallel to the fibers). Endless double chains of SiO_4 are found in amphiboles

and, according to Warren, explain the fibrous structure of amphiboles and chrysotile, as discussed later. Now a double chain consisting of alternating SiO_4 and AlO_4 groups should be nearly as strong as one consisting of SiO_4 entirely and should impress its individuality upon the structure as a whole.

Mullite and sillimanite are identical in structure, according to Taylor (10), except for the fact that one O ion out of every forty O is missing in mullite. This behavior is unexplained so far.

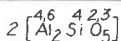
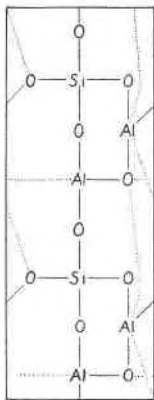

FIG. 14. Sillimanite.

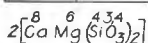
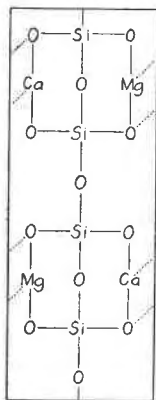

FIG. 16. Diopside.

ANDALUSITE. In andalusite, Al_2SiO_5 , Taylor (23) found that one-half of the Al have six coordinates and are arranged as in cyanite and sillimanite. The other half of the Al ions possess five coordinates, which is rather unusual. Each O is linked to two Al and one Si or to three Al. Fig. 13 would illustrate this structure if the number of bonds of two Al ions were reduced from 6 to 5.

SILICATES WITH SELF-CONTAINED AGGREGATES OF SiO_4 GROUPS

As the ratio of Si:O decreases below 1:4 aggregates like Si_2O_7 (Fig. 1,b), Si_3O_9 (Fig. 1,c), and Si_6O_{18} (Fig. 2) are found in the structures. Such self-contained aggregates are separated from one another by the remaining cations.

THORTVEITITE. Thortveitite, $\text{Sc}_2\text{Si}_2\text{O}_7$, (Zachariasen, 25) contains Si_2O_7 groups linked together by Sc. Scandium has six coordinates and is at the center of a distorted octahedron of O ions.

MELLILITE GROUP. The members of this complex group to which Warren (21) assigns the formula $(\text{Ca},\text{Na})_2(\text{Mg},\text{Al})_1(\text{Si},\text{Al})_2\text{O}_7$ con-

tain the Si_2O_7 group. Al may replace a part of the Si. A structurally different Al may substitute for part of the Mg. Magnesium here has the unusual coordination number 4. Isomorphous replacement in this group, then, is very complicated. For example, if Al replaces a part of Si, Ca should replace a corresponding amount of Na. $\text{Ca}_2\text{Al}(\text{Si},\text{Al})\text{O}_7$ which is gehlenite (Beerman, H., *Am. Min.*, vol. 14, p. 400, 1929) would be the result. If Ca replaced all of the Na and the amount of Si remained constant, Mg should replace all of the structurally equivalent Al resulting in ackermanite $\text{Ca}_2\text{MgSi}_2\text{O}_7$. The rare mineral hardystonite $\text{Ca}_2\text{ZnSi}_2\text{O}_7$ has the same structure as melilite (Fig. 15).

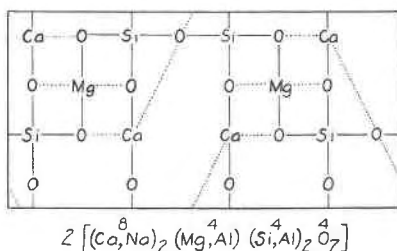

FIG. 15. Melilite.

DANBURITE. Danburite, $\text{CaB}_2\text{Si}_2\text{O}_8$, (Dunbar and Machatski, 31) contains Si_2O_7 groups notwithstanding its apparent excess of O. This excess O ion together with three oxygen ions of three other Si_2O_7 groups forms a tetrahedron at the center of which is placed a B ion. These tetrahedra are arranged in such a way that B_2O_7 groups occur besides Si_2O_7 groups. Calcium has eight coordinates. Oxygen ions may have two, three, or four coordinates.

BENITOITE. The rare mineral benitoite, $\text{BaTiSi}_3\text{O}_9$, (Zachariasen, 27) contains Si_3O_9 groups. This explains its crystallization in the ditrigonal bipyramidal class. It would be very difficult to draw a simple diagram which would show the proper relationship of the cations. No Ba or Ti ions are inside the Si_3O_9 "ring." The "rings" are linked together by these ions, both of which have a coordination number 6. Oxygen has two and three coordinates.

BERYL. Beryl, $\text{Be}_3\text{Al}_2\text{Si}_6\text{O}_{18}$, (Bragg and West, 5) has "rings" consisting of six SiO_4 tetrahedra linked into Si_6O_{18} aggregates. These "rings" are "open," that is no cations are inside of them. They form "wide channels" through the crystal parallel to the *c* axis. It is thought that these channels may account for the inclusion of

helium and other atoms in beryl. The "rings" are interlinked by Al with six coordinates and by Be with four. Oxygen has two and three coordinates. It is practically impossible to draw a satisfactory diagram of beryl with only one molecule.

SILICATES WITH ENDLESS CHAINS OF SiO_4

PYROXENE GROUP. Single endless chains of SiO_4 as shown in Fig. 3, are the characteristic structural feature of the pyroxenes (Warren and Bragg, 9). These chains are parallel to the c axis. The chains are connected to one another by Mg, Fe, Ca and other cations which have a coordination number of 6 or 8. (Fig. 16 diopside). The chains are spaced in such a way that projected on a plane normal to the axis of the chain they have the distribution shown in Fig. 21. Each trapezoid contains one chain seen end on. Each chain is turned 180° about its long axis with respect to its neighbors. The 87° prismatic cleavage of the mineral is produced by breaking of bonds between the chains as indicated by a heavy line in Fig. 21. The bonds between Si and O are very strong and good cleavage can develop therefore only between O and the other cations. In acmite $(\text{Na,Fe})(\text{SiO}_3)_3$ Na replaces Ca, and Fe^{III} the Mg of the diopside molecule. No detailed investigation has been made of augite but it is practically certain that it has the diopside structure.

ENSTATITE. The orthorhombic pyroxene enstatite $(\text{Mg,Fe})\text{SiO}_3$ (Warren and Modell, 17) is very closely related to diopside. Mg replaces Ca with only a slight shift of some of the ions. If a diopside unit cell were reflected on its (100) plane, the unit cell of enstatite would result. The enstatite unit cell, therefore, is almost twice as long in the direction of the a axis as the cell of diopside. This operation reminds one of twinning on a unit cell scale. It also explains the orthorhombic symmetry of enstatite.

AMPHIBOLE GROUP. The endless double chains of SiO_4 groups (Fig. 4) distinguish the amphiboles (Warren, 15 and 16) from the pyroxenes. Parts of the amphibole structure are very similar to the pyroxenes. If one could cut out certain slabs of the tremolite structure, one would obtain sections almost identical with the unit cell of diopside. In Fig. 17 of the tremolite structure, the links of the double chains have been simplified from six SiO_4 groups (as actually found) to four SiO_4 groups. This was necessary in order to produce a reasonably simple diagram. The unit of the chain, and therefore of the chemical formula, is the group Si_4O_{11} as outlined in Fig.

4. Warren (15) and Kunitz¹ independently have shown that the amphibole formula as formerly given is wrong and have substituted the formula $(\text{OH})_2\text{Ca}_2\text{Mg}_5(\text{Si}_4\text{O}_{11})_2$ for tremolite. The O in excess of the Si_4O_{11} groups exists as (OH) in the structure. Each (OH) is linked to 3 Mg. The Mg ion is in the center of an octahedron, four of whose corners are O, the other two OH. Other interesting features in the structure are the large openings designated by "vacant position" in Fig. 17. These positions are unoccupied as long as no trivalent cation replaces a part of Si in the chain. In hornblende, $(\text{OH},\text{F})_2(\text{Na},\text{K},\text{Ca},\text{Mn})_{2-3}(\text{Mg},\text{Fe},\text{Mn},\text{Ti},\text{Al})_5(\text{Si},\text{Al})_8\text{O}_{22}$, according to Warren (16) these "vacant positions" contain alkali ions when Al has replaced a part of the Si. As in melilite, the possible combinations of replacement are very numerous in hornblende and other amphiboles. Warren's paper should be consulted for details. The cleavage of the amphiboles may best be explained with the aid of a diagram similar to Fig. 21. The cleavage will pass around the double chains as indicated in Fig. 21 for single chains, but the general direction of the line now makes an angle of $(56 \times \frac{1}{2})^\circ$ with the a axis instead of $(93 \times \frac{1}{2})^\circ$.

ANTHOPHYLLITE, $(\text{OH})_2\text{Mg}_7(\text{Si}_4\text{O}_{11})_2$, (Warren and Modell, 18) bears the same structural relationship to tremolite as enstatite to diopside. In other words, the unit cell of anthophyllite consists of the unit cell of tremolite which has been doubled by reflection on the (100) plane.

CHRYSOTILE. The structure of the chrysotile asbestos $(\text{OH})_6\text{Mg}_6(\text{Si}_4\text{O}_{11}) \cdot \text{H}_2\text{O}$ is built around the same double chains Si_4O_{11} as the amphiboles (Warren and Bragg, 32). To each chain there are attached the requisite Mg and (OH) groups. One molecule of water is also in the structure. Mg has six coordinates. Each (OH) is linked to three Mg. Each chain is linked to its neighbors by very few and relatively weak bonds which explains the fibrous structure of asbestos.

SILICATES WITH SHEETS OF SiO_4 GROUPS

W. L. Bragg (37) and Pauling (29) simultaneously proposed sheets consisting of interlinked SiO_4 groups (Fig. 5) for silicates which have excellent basal cleavage and hexagonal or pseudohexagonal symmetry. A unit of such a sheet has the formula Si_4O_{10} . All the tetrahedra of SiO_4 in a sheet point in the same direction. The size of the "meshes" in the sheet is determined by the SiO_4 groups.

¹ Kunitz, W., *Neues Jahrb., Beil. Bd.*, 60, A, p. 228, 1929.

Since these are practically constant the "meshes" will vary very little in different minerals containing such sheets. The sizes of the unit cells of such minerals in the a and b directions should be very similar. Mauguin (34) was the first investigator who pointed out this fact.

MUSCOVITE. In muscovite, $(\text{OH})_2\text{KAl}_2(\text{Si}_3\text{Al})\text{O}_{10}$, one-fourth of the Si in the Si_4O_{10} sheets is replaced by Al resulting in $(\text{Si}_3\text{Al})\text{O}_{10}$ sheets. Adjoining sheets have their tetrahedra pointing toward each other (Fig. 22). Between the two sheets are the other Al ions which have six coordinates and the OH groups. Four coordinates of each Al link two $(\text{Si}_3\text{Al})\text{O}_{10}$ sheets together. The other two coordinates hold the (OH) in the structure. Fig. 22 shows the succession of sheets in muscovite. As will be noticed, the K ions occur in layers between pairs of sheets and, on account of their low chemical valency, tie these sheets together but loosely. Therefore, cleavage occurs in mica along these alkali planes. Incidentally, these planes in muscovite are almost exactly one one-millionth of a millimeter apart. Fig. 18 shows muscovite diagrammatically. The part of the formula inside the SiO_4 square is a powerful link between two superimposed sheets, while the K ions would have to be imagined between these superimposed units of sheets. (Pauling, 29, and Jackson and West, 33.)

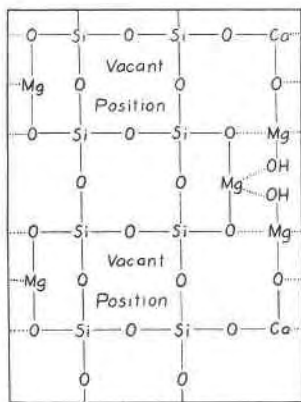

(3 OH) $_2$ Ca $_2$ Mg $_5$ (4 Si $_4$ O $_{11}$) $_2$

FIG. 17. Tremolite.

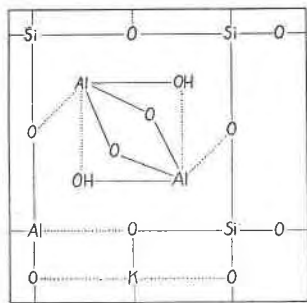

(2 OH) $_2$ K $_1$ Al $_2$ (1 Si $_3$ Al) $_1$ O $_{10}$

FIG. 18. Muscovite.

PHLOGOPITE. Phlogopite, $(\text{OH})_2\text{KMg}_3(\text{Si}_3\text{Al})\text{O}_{10}$, differs from muscovite only by a difference in structure occurring between the

SiO₄ sheets (Pauling, 29). Two Mg ions take the place of the two Al ions. The third Mg occupies a position in the same plane which had been vacant in muscovite (indicated by *x* in Fig. 22). This is possible because the chemical valency of 3Mg = 2Al. In muscovite each (OH) is linked to two Al, in phlogopite each (OH) must be linked to three Mg since the number of (OH) groups remains constant. (Fig. 19).

BIOTITE does not differ from phlogopite except in the replacement of Mg by Fe.

MARGARITE. In the brittle micas (Pauling, 29), for example in margarite, (OH)₂CaAl₂(Si₂Al₂)O₁₀, a very similar structure exists. More Al than in muscovite is substituted in the Si₄O₁₀ sheets giving Si₂Al₂O₁₀. Calcium replaces K. This increase in valency between pairs of sheets impairs the perfect cleavage and deprives the mineral of its elasticity.

PYROPHYLLITE. Pyrophyllite, (OH)₂Al₂Si₄O₁₀, belongs to the kaolin group. According to Pauling (29), it is closely related to the micas. There is no substitution at all of Al in the Si₄O₁₀ sheets. The structure between sheets is exactly as in muscovite. Each pair of sheets with (OH)₂Al₂ between is electrically neutral, however. No alkalis but only stray valences link these units together. Therefore pyrophyllite is very soft and slippery.

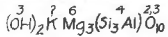
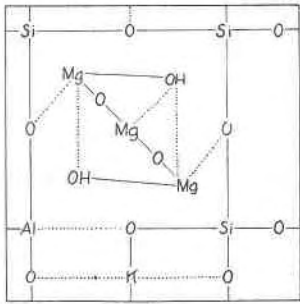

FIG. 19. Phlogopite.

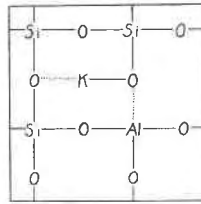

FIG. 20. Orthoclase.

TALC. Talc, (OH)₂Mg₃Si₄O₁₀, bears the same relation to phlogopite that pyrophyllite has to muscovite (Pauling, 29). No Al occurs in the Si₄O₁₀ sheets and the Mg and (OH) groups in talc are in the same position as in phlogopite. The pairs of sheets with (OH)₂Mg₃ between form electrically neutral layers, resulting in softness and slippery feel of the mineral.

FELDSPAR TYPE FRAMEWORK OF SiO_4 GROUPS

The feldspar type was first predicted by Machatski (14). It consists of a framework of tetrahedra of SiO_4 (with AlO_4) linked in such a way that each O of a tetrahedron is shared by another tetrahedron (Fig. 6). Al behaves like Si in these structures. The other cations are enclosed in these tetrahedral frameworks some of which are quite "open."

FELDSPARS. Though the feldspars have been under investigation for a number of years (Schiebold, 24) their structures are only incompletely known. The chief difficulty seems to be that the Al positions can not be distinguished from Si positions since an x -ray reflection from an Al ion is about equally intense as a reflection from a Si ion. It is practically certain that Al in the feldspars has four coordinates like Si. The K, Na, or Ca ions inside the framework of tetrahedral groups probably have six or more coordinates to the O of the tetrahedra. Diagrams of the feldspars type will of necessity resemble the sheet structures since frameworks can not be shown in two dimensions. Fig. 20 is probably the simplest possible diagram for orthoclase. In anorthite an Al would replace another Si and Ca would take the place of Na.

SODALITE. Sodalite, $\text{Na}_4\text{Al}_3\text{Si}_3\text{O}_{12}\text{Cl}$, consists of a framework of $\text{Al}_6\text{Si}_6\text{O}_{24}$ in which tetrahedra of AlO_4 alternate with SiO_4 groups. The structure looks similar to Fig. 6. According to Jaeger (35) and Pauling (28) the Na and Cl are inside the framework. Each Na is linked to three O and one Cl. Each Cl is held by four Na. Helvite $(\text{Mn, Fe, Zn})_4\text{Be}_3\text{Si}_3\text{O}_{12}\text{S}$ has a similar structure in which BeO_4 groups take the place of AlO_4 in the framework.

NOSELITE, $\text{Na}_4\text{Al}_3\text{Si}_3\text{O}_{12} \cdot \text{NaSO}_4$

LAZURITE, $\text{Na}_4\text{Al}_3\text{Si}_3\text{O}_{12} \cdot (\text{Na, Ca})\text{SO}_4$

HAÜYNITE, $\text{Na}_4\text{Al}_3\text{Si}_3\text{O}_{12} \cdot \text{NaS}_3$

These three minerals are built on the same framework as sodalite. Instead of Cl the radicals indicated above occupy a large part of the inside of the framework. They are not tightly held and substitution of one for another has been possible in the laboratory.

ANALCITE. The structure of analcite, $\text{NaAlSi}_2\text{O}_6 \cdot \text{H}_2\text{O}$, has presented many difficulties (Taylor, 22). It is certain now that it is tetragonal instead of cubic, though four investigators, including the writer, placed analcite into a cubic space group according to x -ray data. The reason for its tetragonal character is not to be found in the actual reflections that one obtains but in the fact that the 16

Na, 16 Al, 32 Si, 96 O, and 16 H₂O positions which must be put into a unit cell are an impossible stable combination in any cubic space group.

Analcite consists of a framework of SiO₄ and AlO₄ groups which is similar to those described above. The exact positions of Na which probably has six coordinates are not yet known. Each Na is linked to at least four O and probably to two H₂O. The water occurs in relatively wide channels parallel to the body diagonals of a cubic lattice. How it is held there is a matter of conjecture. The structure does not collapse when the water is driven off below 700°C (as investigated by the writer). This shows that H₂O is not an essential constituent as far as structural support is concerned. Since the mineral can also absorb this water again, the H₂O groups must be able to move rather freely in the channels described.

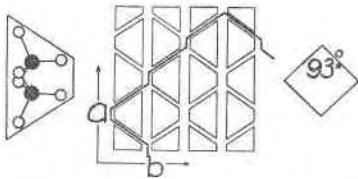

FIG. 21. Diagram explaining the reason for the position of the cleavage planes in pyroxenes, after Warren.

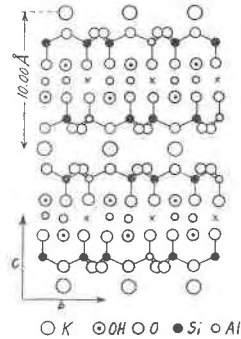

FIG. 22. Diagram showing the sequence of ionic planes in muscovite.

CONCLUSION

The structures of the silicates which have been completely investigated are reviewed. Eight types of structures exemplified by more than 30 single silicates or groups of silicates are discussed. A few observations by the writer with regard to the development of cleavage and with respect to endless double chains of alternating SiO₄ and AlO₄ groups are included. Structural diagrams for each group and certain members of these groups are shown. The purpose of these diagrams is to indicate how the ions are grouped and which of them are linked together. The diagrams are to take the place of complicated projections not easily understood by mineralogists who have had no opportunity to study actual models of the structures.

REFERENCES

1. Vegard, L., *Phil. Mag.*, vol. **1**, pp. 1151, 1926; *Z. Krist.*, vol. **67**, p. 482, 1928.
2. Wyckoff, R. W. G., and Hendricks, S. B., *Z. Krist.*, vol. **66**, p. 73, 1927.
3. Bragg, W. L., and Brown, G. B., *Z. Krist.*, vol. **63**, p. 538, 1926.
4. Menzer, G., *Z. Krist.*, vol. **69**, p. 300, 1928.
5. Bragg, W. L., and West J., *Proc. Roy. Soc., A*, vol. **111**, p. 691, 1926.
6. Brown, G., and West, J., *Z. Krist.*, vol. **66**, p. 154, 1927.
7. Bragg, W. L., and Zachariasen, W. H., *Z. Krist.*, vol. **72**, p. 518, 1930.
8. Taylor, W. H., and West, J., *Z. Krist.*, vol. **70**, p. 461, 1929.
9. Warren, B., and Bragg, W. L., *Z. Krist.*, vol. **69**, p. 168, 1928.
10. Taylor, W. H., *Z. Krist.*, vol. **68**, p. 530, 1928.
11. Pauling, L., *Proc. Nat. Acad. Sci.*, vol. **14**, p. 613, 1928.
12. Alston, N. A., and West, J., *Z. Krist.*, vol. **69**, p. 149, 1928.
13. Machatski, F., *Centralb. Min.*, A, **1928**, p. 97.
14. Warren, B. E., *Z. Krist.*, vol. **72**, p. 42, 1929.
15. " " " *Z. Krist.*, vol. **72**, p. 493, 1929.
16. " " " and Modell, D. I., *Z. Krist.*, vol. **75**, p. 1, 1930.
17. " " " and " " " *Z. Krist.* vol. **75**, p. 161, 1930.
18. St. Náray-Szabó, Taylor, W. H., and Jackson, W. W., *Z. Krist.*, vol. **71**, p. 117, 1929.
19. St. Náray-Szabó, *Z. Krist.*, vol. **71**, p. 103, 1929.
20. Warren, B., *Z. Krist.*, vol. **74**, p. 131, 1930.
21. Taylor, W. H., *Z. Krist.*, vol. **74**, p. 1, 1930.
22. " " " *Z. Krist.*, vol. **71**, p. 205, 1929.
23. Schiebold, E., *Trans. Faraday Soc.*, vol. **25**, p. 334, 1929; also *Fortschritte d. Min.*, vol. **14**, p. 62, 1930.
24. Zachariasen, W., *Z. Krist.*, vol. **73**, p. 1, 1930.
25. " " " *Z. Krist.*, vol. **73**, p. 7, 1930.
26. " " " *Z. Krist.*, vol. **74**, p. 139, 1930.
27. Pauling, L., *Z. Krist.*, vol. **74**, p. 213, 1930.
28. " " " *Proc. Nat. Acad. Sci.*, vol. **16**, p. 123, 1930.
29. Warren, B. E., and Trautz, O. R., *Z. Krist.*, vol. **75**, p. 525, 1930.
30. Dunbar, C., and Machatski, F., *Z. Krist.*, vol. **76**, p. 133, 1930.
31. Warren, B. E., and Bragg, W. L., *Z. Krist.*, vol. **76**, p. 201, 1931.
32. Jackson, W. W., and West, J., *Z. Krist.*, vol. **76**, p. 211, 1931.
33. Mauguin, *Compt. rend.*, vol. **186**, p. 879, and p. 1131, 1928.
34. Jaeger, F. M., *Trans. Faraday Soc.*, vol. **25**, p. 320, 1929.
35. Pauling, L., *Jour. Am. Chem. Soc.*, vol. **51**, p. 1010, 1929.
36. Bragg, W. L., *Z. Krist.*, vol. **74**, p. 237, 1930.
37. Gruner, J. W., *Am. Mineral.*, vol. **14**, p. 173, 1929.