

THE AMERICAN MINERALOGIST

JOURNAL OF THE MINERALOGICAL SOCIETY OF AMERICA

Vol. 23

NOVEMBER, 1938

No. 11

MINERALOGY OF THREE SULPHATE DEPOSITS OF NORTHERN CHILE*

MARK C. BANDY, *Harvard University, Cambridge, Mass.*

CONTENTS

	Page
Abstract.....	670
Part I. Geology and Paragenesis.....	670
Introduction.....	670
Geography.....	670
Climate.....	672
Local Topography.....	672
Geomorphology.....	672
Geology of Chuquicamata, Chile.....	673
History.....	673
Outline of Geologic History.....	673
Geology of Quetena, Chile.....	674
History.....	675
Structure.....	675
Geologic History.....	676
Geology of Alcaparrosa, Chile.....	676
History.....	676
Geologic History.....	677
Paragenesis.....	677
Sequence of Deposition.....	677
Table I. Mineral Sequence at Chuquicamata, Quetena, and Alca- parrosa, Chile.....	682
Geochemistry.....	683
Oxidation at Alcaparrosa, Chile.....	684
Oxidation and Enrichment at Chuquicamata, Chile.....	690
Oxidation at Quetena, Chile.....	696
Part II. Descriptive Mineralogy.....	698
Native Elements.....	699
Sulphides and Sulpho-Salts.....	700
Haloids.....	704
Oxides.....	707
Carbonates.....	709
Silicates.....	710
Arsenates—Phosphates.....	711
Nitrates.....	712
Borates.....	712
Sulphates.....	712
Index of Mineral Species.....	759

* Based on a thesis submitted to the Division of Geological Sciences, Harvard University, in 1938, in partial fulfillment of the requirements for the degree of Doctor of Philosophy.

ABSTRACT

This paper gives the results of a study of the mineralogy of Chuquicamata, Quetena, and Alcaparrosa, three sulphate deposits near Calama, in Northern Chile. The sulphate and chloride minerals, their description, their paragenesis, and the geochemistry of their formation, are the primary interest of the paper. The minerals described were collected by the author in 1935.

Seventy-six minerals were identified and studied. Eighteen of these minerals are known only from northern Chile and twelve are known only from these three deposits. An attempt has been made to clear up some of the varietal names and doubtful species that have been described from these mines. Seven new well-defined mineral species were discovered during the research—antofagastite, bandylite, leightonite, ungemachite, and lindgrenite have been described elsewhere; metasideronatrite and parabutlerite are described here. For all of these, complete crystallographic, optical, and chemical data were secured. Important new crystallographic data are presented for the minerals szomolnokite, pickeringite, rhomboclase, botryogen, lapparentite and natrojarosite. New x -ray data were obtained on three minerals and new optical data on sixteen, and nine new chemical analyses are presented.

PART I. GEOLOGY AND PARAGENESIS

INTRODUCTION

A detailed study of the mineralogy of Chuquicamata, Quetena and Alcaparrosa in Northern Chile forms the basis of this paper. The writer worked for five years at Chuquicamata and had ample opportunity to study the deposits in the field. In 1935 he returned to Chile in behalf of Harvard University and the United States National Museum and spent four months collecting minerals throughout northern and central Chile. Extensive suites of specimens were collected from these three deposits and later were studied in the laboratories of Harvard University and the United States National Museum. The sulphate minerals of these deposits are the primary interest of this paper.

The writer wishes to acknowledge the financial assistance given him by the Department of Mineralogy, Harvard University, and the United States National Museum, which made this study possible. He received unstinted aid and advice from Professor Charles Palache, Dr. W. F. Foshag, Mr. E. F. Henderson and Dr. M. A. Peacock, and it is a pleasure to acknowledge this. The writer wishes to mention particularly the aid given by Dr. Harry Berman, whose guidance and unflinching interest in this study contributed in great part to its present form and value.

Geography. Northern Chile is usually divided into three broad topographic and geographic divisions—the Coast Range, the Central Valley and the Cordillera Real. The Coast Range rises abruptly from the Pacific Ocean on the west and reaches elevations of over 1,500 meters. The Central Valley to the east of the Coast Range is a relatively shallow and broad valley from 50 to 100 kilometers wide. The western slopes of

the Cordillera Real form the eastern side of the Central Valley. This great chain of volcanic peaks marks the eastern boundary of Chile.

The deposits of Chuquicamata, Quetena, and Alcaparrosa (Fig. 1) lie near latitude 22° south, longitude 69° west, in the Province of Antofagasta, at elevations ranging from 7,000 to 10,000 feet. They are reached from Antofagasta by train (150 miles) or from Tocopilla by road (90

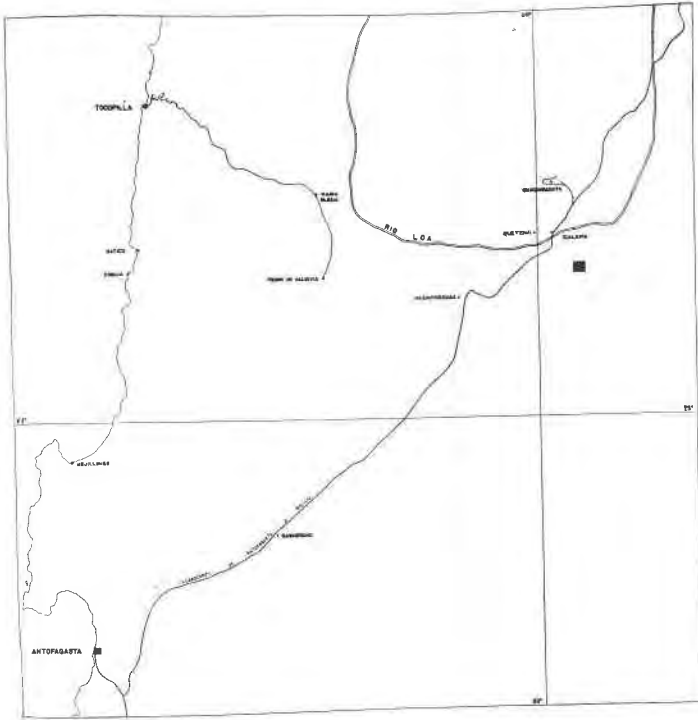

FIG. 1. Key Map of Northern Chile showing relative locations of Chuquicamata, Quetena and Alcaparrosa Mines.

miles). Both of these cities are on the coast. The only other city of any size in the Province is Calama, a small city about equidistant from the three deposits. All these deposits are reached by auto roads from Calama; Chuquicamata 12 miles to the north, Quetena 5 miles to the west, and Alcaparrosa 18 miles to the south.

The deposits lie in the northeast portion of the Atacama Desert on the west slopes of the Cordillera Real, 100 miles west of the crest of this range.

Climate. Northern Chile, particularly the Atacama Desert, is probably one of the driest areas on the earth. These deposits, on the edge of the desert, receive an hour or so of light rain once or possibly twice a year. The average rainfall varies slightly in the three deposits; Chuquicamata, the highest and farthest to the east, receives the greatest annual amount, less than 5 mm.; and Alcaparrosa, the lowest and the one farthest to the west, has a fall of about 1 mm. a year. There is really no "average rainfall" as years may pass when no rain falls. At Alcaparrosa a pile of several tons of coquimbite and other sulphates has been exposed to surface weathering for over sixteen years, yet today, on the outside of the pile, only about a quarter of an inch has been dissolved and a crust of secondary sulphates formed. Under this crust the original sulphates are still fresh and bright. In the Central Valley there were six rains during the Nineteenth Century and there have been two rains during the present century.

The evaporation factor is large and probably there is a precipitation deficiency. Salt crusts at or near the surface are common over much of northern Chile and are probably the result of this precipitation deficiency. Fifty miles to the east of these deposits enough rain falls to support a scattered vegetation during a part of almost every year.

The light rainfall and rapid evaporation in the vicinity of these deposits has allowed the formation of a great variety of water-soluble sulphates, some in large and pure masses, as well as the famous nitrate deposits farther to the west in the Central Valley.

Local Topography. As stated before, these deposits lie in the western foothills of the Cordillera Real, several thousand feet above the floor of the great Central Valley to the west. The dominant topographic features in the vicinity of the deposits are the two great batholithic peaks of Chuquicamata and Limon Verde with the valley of the Rio Loa between them. The deposit at Chuquicamata lies in the batholith, near the eastern edge. Alcaparrosa lies to the west of the Limon Verde batholith. The area is one of mature topography as a whole. The hills have moderate to steep slopes and narrow ridges with alluvium-covered lower reaches. Undrained basins are common, usually occupied by salt plains or salars. Remnants of old salars that have been tapped by tributaries of the Rio Loa are uncommon but can be found.

Geomorphology. Volcanism probably began in Northern Chile in the late Triassic. Following this volcanism there was a slow subsidence and a long period of sedimentation, first of the playa-lake type and then in shallow inland seas during the Jurassic and early Cretaceous. During the Cretaceous, the sea retreated and at the close of the Mesozoic or beginning of the Tertiary folding began and this ushered in the present

cycle. Accompanying the folding was strong volcanism and batholithic intrusion on a grand scale.

The coast range, which follows the present coast line of northern Chile, was probably formed at the close of the Cretaceous. At the beginning of the Pliocene when the general uplift of the Andes began, the Cordillera to the east was raised to its present heights and the coast range was certainly elevated several thousand feet. The Central Valley of Chile, which consists of several valleys or basins with very low divides, was probably formed during this period. The beginning of the period of uplift was marked by erosion of the older rocks under semi-arid conditions with torrential deposition of the debris in thick beds of conglomerates in the broad valleys. Contemporaneous with the uplift, active volcanism was renewed and has continued down to the present, but is probably diminishing. Thick beds of andesitic ash were deposited at this time throughout the Cordillera; some of this material was later washed down into the Central Valley. The conglomerates and ash beds deposited from the middle Tertiary through the Pliocene are now subjected to erosion and in these beds the present drainage has cut youthful canyons. The present arid climate probably began in the Pliocene or early Pleistocene and is probably increasing in aridity.

GEOLOGY OF CHUQUICAMATA, CHILE

Chuquicamata lies on the west slope of a low ridge that disappears under the alluvium of the valley of the Rio Loa, to the south. To the west of the deposit, across a broad shallow valley, is a hill about 1,300 feet high, the main mass of the Chuquicamata batholith. This batholith has an areal extent of about 80 square miles with a north-south axis. The Chuquicamata ore deposit is roughly pear shaped in horizontal section with the wider portion to the north. Its dimensions are approximately 2 miles by 0.7 mile.

History. The first mining in the vicinity was carried on by the aborigines on the gold deposit at the north of the present mine. Recent efforts to find gold, even in traces or colors in this area, have been fruitless. The copper veins were also worked by the aborigines and may have been exploited by the Spaniards. Foreign capital came into the district about 1879 and active mining of the veins on the eastern edge of the deposit continued until about 1920. In 1915 active open-pit mining on a large scale with steam shovels began.

Outline of Geologic History. The geology of the Chuquicamata deposit has been described by Taylor¹ and only a brief outline will be given here:

¹ Taylor: Copper Resources of the World, *16th Int. Geol. Cong.*, vol. II, pp. 473-484, 1935.

1. Intrusion of the granodiorite batholith into the Jurassic shales, probably at the close of the Mesozoic.

2. Fracturing along a fissure on the west side of the deposit followed by the flow of solutions along this fracture and the alteration of the granodiorite to the east of the fracture. Orthoclase and perthite phenocrysts formed in the granodiorite, replacing the salic minerals and possibly some of the femic minerals, although fresh biotite occurs as inclusions in the phenocrysts.

3. Fracturing within the area of the present ore body followed by heavy silicification along the major fractures. With the silicification, hematite and magnetite may have been introduced to the east of the deposit, while pyrite, chalcopyrite, bornite, and molybdenite were introduced into the central and northwest portions. To the northwest these minerals were introduced with a carbonate gangue. Gold may have been introduced at this time in an area of intense silicification to the north.

4. Accompanying and following the silicification there was sericitization of the granodiorite along the central fissures, decreasing in intensity to the east and west, being most intense between the central and west fissures. Orthoclase phenocrysts were not sericitized except in areas near the fissures.

5. Probably a renewal of crushing and shearing along the principal fissures followed by the main period of copper mineralization, namely, pyrite, enargite, and covellite. During this period the veins along the northeast side formed.

6. A period of oxidation and leaching during the middle Tertiary with secondary enrichment and the development of a leached capping over the deposit. The erosion of the iron veins to the east resulted in the formation of iron conglomerates or itabirite.

7. Pliocene uplift with the introduction of an arid climate. Slight movements in the deposit developed flat, rolling fractures.

8. Erosion and oxidation from the Pliocene to the present. A fluctuating water table with very limited rainfall has resulted in the dissemination of the enriched zones formed during the previous stage. The many iron and copper sulphates and other supergene oxide minerals were formed at this time.

GEOLOGY OF QUETENA, CHILE

The Quetena deposit lies to the west of Calama, Chile, near the crest of a steep hill that strikes about north-south. The ridge terminates abruptly at the Rio Salvador, and at its highest point it is about 1,300 feet above the level of the river. It receives about the same amount of rain as Chuquicamata. The deposit was mined for its oxidized copper

ores by an open pit, measuring about 125 feet by 40 feet by 25 feet deep (Fig. 2); notwithstanding this small extent, it exhibits a highly complex mineral assemblage shown in Table I B. It is the type locality for two new mineral species, antofagastite and bandylite; five mineral varieties, quetenite, salvadorite, rubrite, kubeite, and cuprocopiapite, as well as type crystals of pickeringite and co-type crystals of halotrichite.

This deposit is also referred to in older literature as Mina Salvadora.

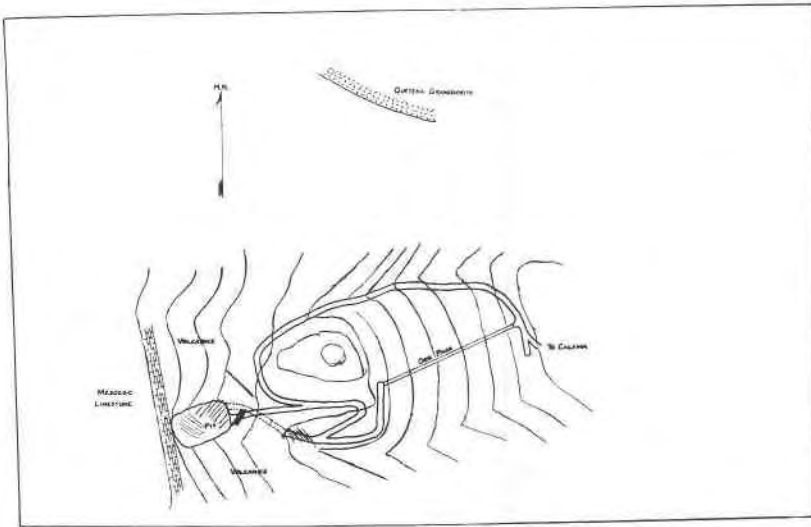

FIG. 2. Sketch Map of Mina Quetena, Chile. Scale 1 inch = .3 mile.
Contour interval—25 ft.

History. A few prospect pits were sunk on the deposit before 1890 but the actual mining records are not available today. Minerals from the deposit appeared in descriptions in Germany about 1890. It was well known that a small tonnage of low-grade ore existed there, but it was not until about 1916 that it was actively worked. Mr. Green obtained the property and transported the ore to the banks of the Rio Salvador, where a small leaching plant was erected. Mining was carried on for several years, after which the property was abandoned due to the decline in the price of copper after the World War. In 1935 an unsuccessful attempt was made to operate the property. The estimated total production of the property is about 10,000 tons, and the present positive reserve of low-grade ore is about 10 tons.

Structure. Quetena occupies a stockwork of quartz veins in a series of lava flows or possibly intrusives at the contact with a series of Jurassic

(Bajocian) cherty limestones. The stockwork is irregular in shape, a type of structure called "rebosadero" by the Chilean miners. The quartz veins vary in width up to ten inches or more. The history of the fracturing is not known and no age can be definitely ascribed to either the flows or the mineralization.

Geologic History. About a half mile to the north of Quetena, an igneous plug of red granodiorite forms the hill known as Cerro Quetena. This plug is probably connected genetically with the Limon Verde batholith. The rock is a normal granodiorite with occasional areas of micropegmatite. The flows about Quetena are probably not related to this plug, as evidence points to their being much older.

The history of the fracturing is not known, but early quartz was introduced into the fractures and crystals grew normal to the walls with well-developed terminations projecting into vugs along the course of the veins. Following the quartz, abundant pyrite and small amounts of copper were introduced. No primary copper minerals were observed by the writer. The centers of the veins, in the capping, are now occupied by a limonite boxwork after pyrite, and copper evidently was not present in sufficient quantity to modify this boxwork. The rock is little altered at a distance from the veins except from supergene agents.

The mineralization probably dates back to the late Mesozoic, while there is little evidence to support an earlier date. The deposit was probably strongly oxidized during the middle Tertiary with the formation of a rich chalcocite zone. The copper and iron sulphates have formed since the Pliocene. Undoubtedly a considerable amount of leached capping has been eroded from the deposit.

A discussion of the geochemistry of the deposit is given under the section on Paragenesis.

GEOLOGY OF ALCAPARROSA, CHILE

The mine Alcaparrosa lies on the west side of Cerro Alcaparrosa, about 3 kilometers southwest of the station of Cerritos Bayos on the railroad from Antofagasta to La Paz, Bolivia. This deposit should not be confused with the more famous sulphate deposit of the same name at Tierra Amarilla, near Copiapó, Chile. The property is reached by an auto road from Cerritos Bayos. It is near the base of the hill, a peak that dominates the landscape in this vicinity. The deposits consist of a series of veins and lenses of varying strikes and dips.

History. There are a number of small, massive isolated sulphate deposits at this property that have been mined over a long period. The deposit is remarkable in the total absence of copper, a feature that distinguishes it from any similar pyritic deposit in northern Chile known

to the writer. Due to the total absence of any other metal, the deposit has had a very limited value. The first work is reported to have been carried on in about 1875. Minerals from the deposit began to be described in Germany about 1880.

The sulphates were first mined for their sulphuric acid content. Inclined pits were sunk on the veins and roemerite and coquimbite were sought as the more favorable minerals. When dissolved in water, roemerite yields free acid, while solutions of coquimbite, when heated, yield free acid through precipitation of iron oxide. These acid solutions were used in leaching copper and silver ores. The large amount of iron in the solutions which would precipitate with the greatest of ease was a great drawback to their use. Mining ceased in the late nineties and was resumed about 1917 but ceased again about 1920. The area may have produced 20,000 tons of sulphates. There may be 5,000 tons of sulphates still available in the present workings and an unknown amount in undeveloped veins. However, of the material in sight, much is in the form of basic sulphates which have little or no value as a source of acid.

This deposit is the type locality for amarantite and hohmannite, for crystals of metavoltine, and for the orthorhombic form of butlerite, parabutlerite. It has yielded an undetermined mineral related to the alums, described in this paper.

Geologic History. The sulphates occur in flows near the base of Cerro Alcaparrosa. The writer believes the deposits to be no older than the Pliocene. They represent oxidized portions of pyritic masses formed close to the surface that have later been subjected to oxidation under increasingly arid conditions. Since Pliocene times erosion has not been great and there has been slight downward migration of the iron and sulphur.

The geochemistry of the deposit is discussed in detail under the section on Paragenesis.

PARAGENESIS

The paragenesis of the oxide minerals in these three deposits will be discussed under two headings—Sequence of Deposition and Geochemistry.

Sequence of Deposition. The sequence of deposition of minerals formed in the oxide zone of ore deposits has been hard to establish. The opaque minerals have been studied intensively, but the far greater number of nonopaque minerals have received little attention. Statements of depositional sequence of these oxide minerals are rare in the literature of ore deposits. Such sequences are established with difficulty. Physical conditions, as well as the chemical composition of the meteoric solutions

passing downward through a deposit, change rapidly from time to time and from place to place. The change in the composition of the solutions may be periodic and give rise to repeated deposition of a certain sequence with complete or partial solution or replacement of the older minerals. There are many factors that may cause oxide minerals to be deposited: among them are degree of saturation, change in alkalinity, loss of volatile gases, change in temperature, change in *pH*. Meteoric waters passing downward dissolve the more soluble minerals or salts first and the less soluble salts later, and unless reactions take place in the solutions these minerals will be redeposited at lower levels. Minerals formed at one time may, at a later time, be wholly or partially redissolved and the fortuitous presence or absence of some other mineral may completely change the character of the next generation of minerals. Oxygen plays an important role, and the availability of this element in the more open channels as contrasted with the solid country rock may give rise to two different groups of minerals deposited from otherwise identical solutions.

In most mining districts, water, one of the essential agents of oxidation, is supplied at more or less regular intervals in sufficient quantity to prevent the water throughout the deposit from becoming uniform in composition for any appreciable period of time. With a more or less constant supply of water, these meteoric solutions rarely build up a uniform concentration of either acids or bases over any appreciable area of the deposit. There is always an abundance of the solvent, and the soluble minerals are rapidly transported to the ground water reservoir. Only the relatively insoluble oxide minerals are left in the supergene zone. As a result, most ore deposits have a relatively limited number of minerals in the supergene zone, minerals that will form from very dilute solutions and once formed are relatively stable, for example, hydrous iron oxide.

In northern Chile, conditions are exceptionally favorable for the formation of sulphates, chlorides and oxides from concentrated solutions and from solutions that maintain a uniform composition over long periods of time. In the three deposits considered in this study, the water table is far below the surface and the primary sulphide horizon, with the exception of portions of Chuquicamata. Rains capable of adding an appreciable amount of water to the deposit, that is, a sufficient amount to even moisten the entire oxide zone, only occur once in a decade as a rule. During the intervening periods the sulphates form from concentrated solutions and then, once formed, change very slowly. There can be no question but that many of the sulphates form from older sulphates through reactions taking place in moist air and not by precipitation from aqueous solutions.

As a case in point showing the difference between the character of deposition of sulphate minerals from concentrated solutions, with essential stability between the solid and liquid phases, and sulphates deposited from supersaturated solutions where no stability exists between the two phases, the famous sulphate deposit of Mina Alcaparrosa at Tierra Amarilla, Chile, might be mentioned. This deposit on the banks of the Rio Copiapó receives periodic rains but in scant quantity, as a rule insufficient to penetrate far into the older sulphates. The original sulphide was pyrite in large echelon lenses. Under more moist conditions than those existing today, the pyrite was oxidized to a number of iron sulphates. The sulphates were present to within a few feet of the surface

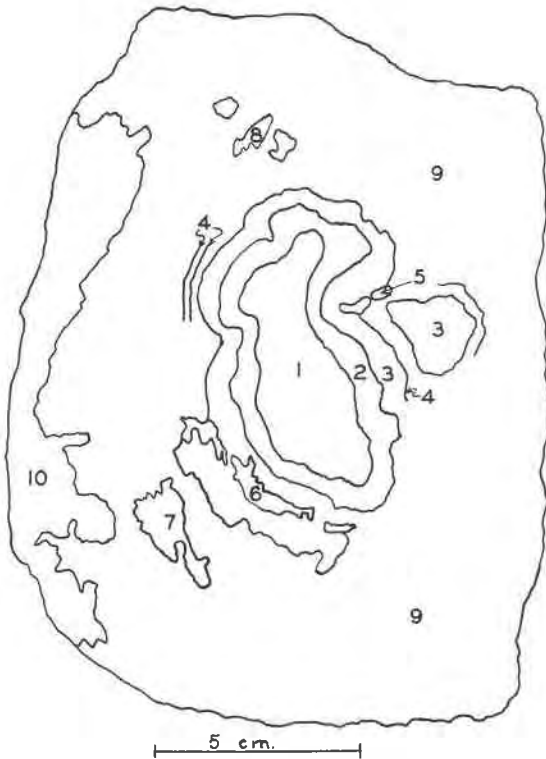

FIG. 3. Sketch of a specimen of zoned sulphates from Quetena, showing distribution of the minerals present.

- | | |
|----------------------------|-------------------------------|
| 1. Pyrite and szomolnokite | 6. Alums |
| 2. Pyrite and halotrichite | 7. Pisanite, var. salvadorite |
| 3. Copiapite | 8. Botryogen, var. quetenite |
| 4. Jarosite | 9. Copiapite and botryogen |
| 5. Parabutlerite | 10. Altered country rock |

and when the deposit was mined a few pillars of the original sulphates were left which are exposed on four sides and have dried out almost completely. As a result, when rain falls on these pillars the water rapidly becomes saturated and supersaturated and then redeposits the sulphates. The solutions penetrate only a few inches into the pillars and their effect is relatively limited. During the dry periods that follow the rains, the pillars dry rapidly and there is little bulk effect from the rain such as would exist if the deposit was a large unit, exposed only on the surface. The effect of the deposition from supersaturated solutions is to form a crust of fine-grained sulphates on the pillars, sulphates composed of normal and basic varieties deposited simultaneously. Underneath this surface crust is a more or less solid mass of basic sulphates that show essentially definite sequence of deposition or formation. These original sulphates were formed under conditions of relative stability, and this permitted the formation of large masses of single mineral species.

Since the sulphates of the deposits here described are derived from pyrite, the general sequence as here given begins with that mineral. In a zoned alteration of a pyrite nodule (Fig. 3), the outer portion is altered first, and, as the alteration proceeds inwards, the sulphate already produced undergoes successive changes in composition, again from the outer rim inward. The sequence from pyrite is given, therefore, by the minerals from the pyrite core outward with the outermost mineral the last to form. This last mineral is in the terminology of this paper the "late" mineral, where pyrite is the "early." This treatment has led to certain relationships that appear to be ambiguous. Pickeringite and halotrichite, as well as fibroferrite, appear as recent efflorescent minerals on the walls of openings in these deposits, forming after all other minerals. Yet both are early minerals, especially halotrichite, which is a normal hydrous ferrous aluminum sulphate. The early crystals of halotrichite often contain inclusions of unoxidized pieces of pyrite. The recent formation of these minerals is probably due to their solubility and a wide depositional range from solutions that are not in stable relationships.

Under average conditions the sulphates and chlorides form in the following order, as determined in this study.

SEQUENCE OF SUPERGENE HYDROUS SULPHATES AND CHLORIDES

<i>Late</i>	Hydrous oxides (limonite)	
	Hydrous basic salts	small percentage of H ₂ O
	Hydrous basic salts	large percentage of H ₂ O
	Hydrous normal salts	large percentage of H ₂ O
	Hydrous normal salts	small percentage of H ₂ O

	Hydrous acid salts	large percentage of H ₂ O
Early	Hydrous acid salts	small percentage of H ₂ O

The above generalized sequence is based, primarily, on a study of the pure hydrous iron sulphates. Departures from this sequence are common, but the "key" minerals in all deposits studied follow this sequence as a rule. "Key" minerals are those minerals that appear frequently in all parts of a given deposit and in different deposits and to which associated minerals can be referred on the basis of sequence of formation. The presence of sodium, calcium, potassium, and magnesium in the sulphates has an effect on the generalized sequence, but this could not be evaluated in this study and no definite conclusions were reached. Additional studies need to be made upon either single veins in similar deposits or upon deposits with a relatively simple and limited mineral assemblage. As seen in the following table, normal hydrous sulphates carrying one of these elements may form with basic iron and copper sulphates. It is realized, of course, that the sequence relationships of these minerals as here determined may be in error and that all sulphates do not follow the sequence outlined above.

Table I represents an attempt to bring together a number of individual sequence determinations. Single specimens or suites of specimens give definite relationships. Key minerals in different groups were correlated and the intermediate minerals were fitted together as closely as the data permitted. The following tabulation of some sequence relationships at Quetena illustrates the difficulties and limitations of the method used.

ACTUAL SEQUENCES		CORRELATED SEQUENCES	
Copiapite	Copiapite	Copiapite	Copiapite
		Voltaite	Voltaite
	Coquimbite	Coquimbite	Coquimbite
	Roemerite	Quenstedtite	Quenstedtite
			Roemerite
Halotrichite			Halotrichite
	Szomolnokite	Szomolnokite	Szomolnokite
Chalcocite			Chalcocite
Pyrite		Pyrite	Pyrite

In Table I more than one sequence is given for Chuquicamata and Quetena. In these deposits it was difficult to determine the relationships between the different occurrences, and it was thought better to give separate lists rather than to try to combine them all into one list on too little data regarding interrelationships. The paragenetic associations of

these minerals will be discussed in the following section on geochemistry, and more fully under the individual species.

TABLE I. MINERAL SEQUENCE AT CHUQUICAMATA, QUETENA, AND ALCAPARROSA, CHILE
A. CHUQUICAMATA

1	2	3
SUPERGENE SULPHIDES	SUPERGENE OXYGEN-BEARING MINERALS	
Chalcocite	Northeast Section—	Central and Western
Covellite	Area of Heavy Pyrite	Sections
Bornite	Veins	
Chalcopyrite		
	<i>Late</i> Limonite	Limonite
PRIMARY MINERALS	Kalinite	Gypsum
	Natrojarosite	Cuprite
<i>Late</i> Covellite	Natroalunite	Molybdc ocher
Enargite	Antlerite	Sulphur
	Cuprocopiapite	Natrojarosite
Fracturing	Picromerite	Picromerite
	Parabutlerite	Antlerite
Bornite	Amarantite	Lindgrenite
Chalcopyrite	Hohmannite	Natroalunite
Pyrite	Copiapite	Natrochalcite
	Fibroferrite	Atacamite
Fracturing	(Tamarugite)	Leightonite
	Aluminite	Turquoise
Pyrite	Metasideronatrite	Bloedite
	Metavoltine	Kroehnkite
Fracturing	Ferrinatrite	Chalcanthite
Magnetite	Tamarugite	
<i>Early</i> Hematite	Coquimbite	
	Roemerite	
	<i>Early</i> Halotrichite	
4	5	6
SUPERGENE OXYGEN-BEARING MINERALS (Cont.)	PARAGENESIS NOT ESTABLISHED	
Southeast Area	East Side, Weakly Sulphatic	Sphalerite
		Tetrahedrite
Opal	Brochantite	Soda Niter
Chrysocolla	Tenorite-manganite-limonite	Mirabilite
Azurite	Cuprite	Thenardite
Malachite	Native Copper	Cerussite
Atacamite		Chenevixite
		Pisanite
		Calcite
		Magnesite
		Halite
		Ulexite

in the field and in the laboratory, although the laboratory experiments have not been as successful in furnishing data as was hoped for.

More progress has been made and more definite conclusions reached in the study of the various oxide systems, in particular $\text{CuO-SO}_3\text{-H}_2\text{O}$ and $\text{Fe}_2\text{O}_3\text{-SO}_3\text{-H}_2\text{O}$. The former system was studied most successfully by Posnjak and Tunell.² The latter system was studied by Posnjak and Merwin and others.³ These works are not in entire agreement and the work of Posnjak and Merwin is here taken as the best available.

The geochemistry of the oxidation at Alcaparrosa where no copper is involved and at Chuquicamata where copper is an important constituent will be discussed in detail, while the oxidation at Quetena will be considered in relation to these two deposits.

Oxidation at Alcaparrosa, Chile

There are two types of oxidation at Alcaparrosa, or what might be called "two lines of descent," one involving iron sulphates, or sulphates carrying iron, the other involving non-ferrous sulphates, principally alums. For comparison with the work on the system $\text{Fe}_2\text{O}_3\text{-SO}_3\text{-H}_2\text{O}$ the two lines will be discussed separately.

In one of the inclined pits at Alcaparrosa a complete series of sulphates from the surface to fresh pyrite was exposed. This series is described here in detail to give a picture of the deposit. The different pits on the property show different minerals, but the relationships are, in general, the same. The section from the surface to the bottom is as follows:

1. Alluvium, 1-4 feet.
2. Mirabilite altered to thenardite with associated nitrates, 8 inches. Spotty and variable in thickness. Probably not genetically related to the pyrite deposits.
3. A white pulverulent mixture of several minerals, mostly alums with some gypsum, variable in thickness, usually in pockets.
4. A hard to pulverulent brown manto of jarosite and iron oxide, 1 to over 6 inches thick.
5. In isolated areas, brown to orange parabutlerite. Evidently an alteration product of the underlying copiapite. At the bottom this layer becomes distinctly fibrous in character with the general appearance of fibroferrite. Average, 8 inches thick.
6. A layer of variable thickness of greenish-yellow to brown copiapite. The crystals are minute in size as a rule. Large, megascopic, brilliant yellow crystals are developed only

² Posnjak and Tunell, *Am. Jour. Sc.*, vol. 18, p. 1, 1929.

³ Posnjak and Merwin, *Jour. Am. Chem. Soc.*, vol. 44, p. 1965, 1922; Merwin and Posnjak, *Am. Mineral.*, vol. 22, pp. 567, 1937.

Cameron and Robinson, *Jour. Phys. Chem.*, vol. 11, p. 641, 1907.

Wirth and Bakke, *Zeits. anorg. Chem.*, vol. 87, p. 13, 1914.

Scharizer, *Zeits. Krist.*, vol. 43, p. 125, 1907; vol. 46, p. 432, 1909; vol. 52, p. 385, 1913, etc.

Baskerville and Cameron, *Jour. Phys. Chem.*, vol. 39, p. 769, 1935.

where country rock occurs. A feature of this layer is the occurrence in the copiapite of coarse, bladed, pale bluish-white, milky pseudomorphs of coquimbite after quenstedtite. The copiapite is the younger mineral and the crystals show little evidence of replacement by the copiapite. Thickness, 0-12 inches.

7. A massive layer of light purple, finely crystalline coquimbite. The upper contact with the copiapite is sharp, as a rule. The layer grades downward into the lower bed. Thickness, 2-10 inches.

8. A massive layer of dark purple and reddish purple coquimbite and roemerite, intimately associated. The roemerite is replaced by the coquimbite. Crystals and crystal druses are abundant. Associated with the coquimbite, in vugs, are crystals of lapparentite, pickeringite, quenstedtite and pseudomorphs of coquimbite after quenstedtite. Large crystals of coquimbite, up to $\frac{3}{4}$ inch, occur in the more massive replaced quenstedtite. At the bottom of the horizon rounded masses of bright yellow roemerite appear. Thickness, 3-20 inches.

9. A layer of variable composition. At the top is massive coquimbite with round, isolated areas of szomolnokite and pyrite, surrounded by a layer of roemerite. The coquimbite grades downward into massive reddish-brown roemerite with rounded areas of yellow roemerite. The same round areas of szomolnokite and pyrite occur in the roemerite as well as in the coquimbite. These areas may vary from a fraction of an inch to several inches in diameter. Thickness from 3 inches to 2 feet.

10. A layer of unknown thickness but certainly up to two and a half feet thick of colorless and faintly brownish-purple rhomboclase and intimately associated szomolnokite with bright angular pieces of pyrite scattered through the minerals. Where the pyrite is most abundant the szomolnokite increases in abundance in relation to rhomboclase. The contact between the upper bed of roemerite and the rhomboclase-szomolnokite is line-sharp and apparently plane. There is no apparent change in texture as one passes from the colorless rhomboclase to the reddish-brown roemerite.

From this section the following sequence can be more or less definitely established.

SEQUENCE I		SEQUENCE II	
Mirabilite—soda niter			
Alums—gypsum			
Jarosite	$\text{KFe}_3(\text{SO}_4)_2(\text{OH})_6$	Basic	
Parabutlerite	$\text{Fe}_2(\text{SO}_4)_2(\text{OH})_2 \cdot 4\text{H}_2\text{O}$	Basic	
Copiapite	$\text{Fe}_4(\text{SO}_4)_6(\text{OH})_2 \cdot 16\text{H}_2\text{O}$	Basic	
Quenstedtite	$\text{Fe}_2(\text{SO}_4)_3 \cdot 10\text{H}_2\text{O}$	Normal	
Lapparentite	$\text{Al}_2(\text{SO}_4)_2(\text{OH})_2 \cdot 9\text{H}_2\text{O}$	Basic	
Pickeringite	$\text{MgAl}_2(\text{SO}_4)_4 \cdot 24\text{H}_2\text{O}$	Normal	
Coquimbite	$\text{Fe}_2(\text{SO}_4)_3 \cdot 9\text{H}_2\text{O}$	Normal	
Quenstedtite	$\text{Fe}_2(\text{SO}_4)_3 \cdot 10\text{H}_2\text{O}$	Normal	
Roemerite	$\text{Fe}'' \cdot \text{Fe}'''(\text{SO}_4)_4 \cdot 14\text{H}_2\text{O}$	Normal	Roemerite
			Rhomboclase $\text{Fe}_2(\text{SO}_4)_3$ $\cdot \text{H}_2\text{SO}_4 \cdot 8\text{H}_2\text{O}$ Acid
Szomolnokite	$\text{FeSO}_4 \cdot \text{H}_2\text{O}$	Normal	Szomolnokite
Pyrite	FeS_2		Pyrite

It is at once apparent that in the sequence outlined above the otherwise orderly change from acid or normal sulphates to later basic sul-

phates and from ferrous to ferro-ferric to ferric sulphates is interrupted by rhomboclase. If the field occurrence is taken at its face value, we have (Sequence II) a normal ferrous sulphate, szomolnokite, altering to an acid ferric sulphate, rhomboclase, and this in turn altering to a normal ferro-ferric sulphate, roemerite. In the other case (Sequence I) we have a normal ferrous sulphate altering to a normal ferro-ferric sulphate, and this in turn to normal and then basic ferric sulphates. It is believed that some localized circumstance, explained in a later section, caused the formation of rhomboclase in the place it now occupies in the deposit.

No study has been made of either of the systems $\text{FeO-SO}_3\text{-H}_2\text{O}$ or $\text{FeO-Fe}_2\text{O}_3\text{-SO}_3\text{-H}_2\text{O}$, but Posnjak and Merwin⁴ have studied the system $\text{Fe}_2\text{O}_3\text{-SO}_3\text{-H}_2\text{O}$ from 50 degrees to 200 degrees. They obtained rhomboclase, copiapite and monoclinic butlerite among the artificial minerals formed at the lower temperatures. The minerals obtained and the solutions from which they formed at 50 degrees are tabulated below.

MINERAL	LIQUID PHASE			
	Weight Per Cent			
	Fe_2O_3	SO_3	H_2O	$\text{SO}_3/\text{Fe}_2\text{O}_3$
Rhomboclase	0.09- 5.55	55.34-33.96	44.57-60.49	6.15-6.1
Copiapite	16.78-21.00	30.72-28.2	52.50-50.8	1.8 -1.3
Butlerite	21.00-20.13	28.2 -27.18	50.8 -52.69	1.3

Also within the range studied, the various classes of iron sulphates were obtained from liquids of the composition noted below.

CLASS	LIQUID PHASE			
	Weight Per Cent			
	Fe_2O_3	SO_3	H_2O	$\text{SO}_3/\text{Fe}_2\text{O}_3$
Acid	0.00- 5.55	75.37-33.96	24.56-60.49	Inf. -6.1
Normal	8.56-16.78	32.52-30.72	58.92-52.50	3.8 -1.8
Basic	16.78- 0.14	30.72- 0.39	52.50-99 47	1.8 -2.8

It is observed from these data that sulphuric acid content is the dominating factor in the type of sulphate formed. It is also noteworthy that many of the sulphates so abundant in nature were not obtained in these studies, coquimbite for example.

Scharizer and others have obtained a number of artificial salts that correspond to natural minerals in various experiments. Some of these data, in compositional ratios, are given here for comparison with natural

⁴ *Op. cit.*

sequence relations of the minerals and for comparison with the data of Posnjak and Merwin given above.

	weight per cent
Szomolnokite	$H_2O/SO_3 = 2.186-7.93^5$
Copiapite and coquimbite	$Fe_2O_3 : SO_3 : H_2O = 1:3.47:30.88^6$
Coquimbite and rhomboclase	$Fe_2O_3 : SO_3 : H_2O = 1:6.69:55.77^6$
Copiapite	$Fe_2O_3 : SO_3 : H_2C = 1:6.45:41.94^7$
Rhomboclase	$H_2O/SO_3 = 3.744-3.664^7$

There are some additional data, mostly by Scharizer, but there is serious doubt as to whether his solutions reached equilibrium. The data are, therefore, of little value in this connection and are not quoted here, although his findings check the sequences determined in these deposits. This might be expected, as many of these natural sulphates formed from solutions that had not reached a state of equilibrium with the solid phases.

From the foregoing data it is apparent that acid, normal and basic salts are deposited in this order from solutions that are more and more dilute and from solutions in which the acid content decreases in proportion to the iron, although in the very dilute solutions the actual ratio increases a little.

The writer offers the following explanation for the formation of rhomboclase at Alcaparrosa. It is believed to be later than the roemerite and szomolnokite with which it is associated, and to be a sulphate derived from the oxidation of these two minerals. The szomolnokite formed first from the oxidation of the pyrite under conditions of limited water and oxygen. It was then partially oxidized under similar conditions to roemerite. At some subsequent period, while this process of oxidation was still going on, probably after it was well advanced, sufficient moisture appeared in the deposit to allow the formation of a water table, and this probably maintained a given horizon for some time in the bottom of the deposit. The water contained a high percentage of salts and was relatively strongly acid. In this water, sufficient oxygen was present, and was added from time to time, to oxidize the roemerite and part of the szomolnokite to the acid sulphate rhomboclase. An origin of this nature would explain the more or less horizontal, exceptionally sharp contact between the roemerite and rhomboclase-szomolnokite mixture. It would also explain the complete oxidation of the roemerite, a readily soluble sulphate, and the partial oxidation of the ferrous sul-

⁵ Kenrick, *Jour. Phys. Chem.*, vol. 12, p. 699, 1908.

⁶ Wirth and Bakke, *Zeits. anorg. Chem.*, vol. 87, p. 40, 1914.

⁷ Scharizer, *Doelter*, 4 pt. 2, 572, 1929.

phate szomolnokite, which is less soluble and would require more oxygen and acid to oxidize it to an acid ferric sulphate.

The relationships of coquimbite and quenstedtite are noteworthy. These minerals have the composition:

Quenstedtite	$\text{Fe}_2(\text{SO}_4)_3 \cdot 10\text{H}_2\text{O}$
Coquimbite	$\text{Fe}_2(\text{SO}_4)_3 \cdot 9\text{H}_2\text{O}$

According to the general sequence relationships of the sulphates, coquimbite would be expected to form first and then be followed by quenstedtite. The relationship is, in general, in agreement with this sequence, but there is a marked overlap of the period of the two minerals. As a result there appear to be two ages of quenstedtite, one replaced by coquimbite and one later. The dull, pale blue, milky pseudomorphs probably formed as quenstedtite at the same time as coquimbite was forming. The coquimbite had the power to replace the quenstedtite under certain conditions, while the reverse replacement was apparently difficult or impossible. The coquimbite would form from the more acid and more concentrated solutions, and after a rain or some influx of water into the deposit the first solutions would be diluted and quenstedtite would form and as the solutions became more acid and more concentrated the depositional range for coquimbite would be reached and it would form and at the same time replace the older quenstedtite. This type of deposition went on during the latter half of the coquimbite period. The small amount of crystallized quenstedtite may have formed along with lapparentite and pickeringite. The formation of these minerals will be discussed later but the conclusions reached will be applicable, probably, to the formation of crystals of quenstedtite that have not been replaced by coquimbite. Theoretically, a point is reached in the deposition of sulphates from a solution where the solid phase is not readily soluble and minerals are deposited from solutions that are less and less concentrated. If this is true, quenstedtite would have a period of formation later than coquimbite and the crystals of this mineral may have formed in this manner, from more dilute solutions.

All of the basic iron sulphates are later than the normal sulphates. The relationship of copiapite and later parabutlerite is definite in both the hand specimen and in the field. The natural occurrence coincides exactly with the data obtained on artificial systems. At the contact of parabutlerite and copiapite much of the parabutlerite retains the platy, radiating structure of the copiapite, from which it is derived.

The conditions of formation of the non-ferrous sulphates cannot be treated with the same assurance as the pure iron sulphates. In the field their volume is much less in these deposits and their occurrence is spotty.

Minerals that are compound sulphates of iron and some other element are more abundant, but they shed little light on the sequence of the non-ferrous sulphates. Potassium and sodium may appear in these minerals along with the iron but there is no consistent relationship.

Jarosite is definitely a late mineral. This is a potash-iron sulphate and at Alcaparrosa occurs above the parabutlerite. Other near-surface compound sulphates carrying iron are:

Botryogen	$Mg_2Fe_2(SO_4)_4(OH)_2 \cdot 14H_2O$
Metavoltine	$(K, Na)_2Fe_2(SO_4)_4 \cdot 8H_2O$

Botryogen is abundant in one of the pits as a late mineral, later than copiapite with which it is associated. The only other associated minerals are kalinite and mendozite, potassium and sodium alums. Metavoltine occurs in rather definite, narrow relationships. It occurs near the surface associated with copiapite and various alums, both of which are younger minerals.

From these associations it is evident that the alums, normal sulphates, are late minerals. Associated with the lapparentite, a basic sulphate, are pickeringite and iron sulphates.

<i>Late</i>	Copiapite	$Fe_4(SO_4)_6(OH)_2 \cdot 16H_2O$
	Pickeringite	$MgAl_2(SO_4)_4 \cdot 24H_2O$
	Lapparentite	$Al_2(SO_4)_2(OH)_2 \cdot 9H_2O$
	Quenstedtite	$Fe_2(SO_4)_3 \cdot 10H_2O$
<i>Early</i>	Coquimbite	$Fe_2(SO_4)_3 \cdot 9H_2O$

It is difficult to explain the formation of a basic aluminum sulphate preceded and followed by normal sulphates. However, the lapparentite is present in a very limited quantity. In other areas of the deposit, near the surface, lapparentite is a later mineral and follows and is followed by alums. However, the writer is rigorously following the sequence determinations on individual specimens; and, while in the deposit, in general, there is as much evidence that lapparentite is a late mineral as an early one, in this case it is definitely followed by pickeringite, a mineral closely related in composition to the alums.

As stated above, the alums are late minerals, all of them being normal sulphates and forming later than basic iron sulphates. Much of the pickeringite is in the form of radiating acicular crystals growing on other crystals in vugs and veins. The last mineral to form in present openings, covering the walls of many of the pits as an efflorescence is the basic ferric sulphate fibroferrite, $Fe_2(SO_4)_2(OH)_2 \cdot 9H_2O$. This mineral offers the key to certain anomalous minerals, especially those present in minor quantities, which form under conditions of limited hydration. With no

water present in liquid form it is possible for them to form throughout the deposit. As in the case of lapparantite and pickeringite, on coquimbite, in the bottom of the deposit, the minerals may have altered from earlier formed minerals but a short time previous to removal and are now in association with early minerals and in zones beneath minerals that are much older. At Chuquicamata we find fibroferrite associated with amarantite, hohmannite and botryogen where it has formed earlier than any of these minerals from acid, aqueous solutions. Likewise we find it as an efflorescence of very recent origin in vugs, etc., the product of hydration.

The conclusion reached is that minerals of this type can form in any opening when sufficient water vapor is present. These hair-like forms grow out from the walls or from the support by addition of material to the bottom of the crystal, that is, the point of support of the crystal. The writer has observed the formation of fibroferrite at Quetena in this manner after a moist period, and specimens of metavoltine, copiapite and rhomboclase began to develop fibroferrite on their surfaces after exposure in laboratories in the United States for a few months.

The problem of the sequence of the non-ferrous sulphates must be left open. Where the minerals contain both iron and some other base, isolated sequence relationships can be determined at Alcaparrosa, but with the pure non-ferrous sulphates a consecutive sequence cannot be determined in relation to the iron sulphates. Most of them are later than the iron minerals. Since the non-metallic elements are obtained from the country rock, reactions between the sulphate solutions and the wall rock would probably tend to dilute the solutions, and variations in the intensity of reactions and degrees of dilution might account for the variations in the sequence of formation found in this study.

Oxidation and Enrichment at Chuquicamata, Chile

At Chuquicamata and to a less degree at the two smaller sulphate deposits, the oxidation of the ore has resulted in a rather wide distribution of the valuable metals and, as a rule, no sharp horizons of demarcation between leached capping, enriched zone and primary sulphides exist. The rapidity of oxidation of the pyrite-enargite veins was roughly proportional to the ratio of pyrite to enargite. In the massive enargite veins to the northeast, oxidation was slow, and many veins show enargite near the surface, while in the area of disseminated enargite and in areas of abundant pyrite the zone of oxidation is much deeper and oxidation must have been much more rapid. While similar minerals have formed in almost all areas, especially the common and abundant minerals, some of the rarer minerals are limited to definite areas at Chuquicamata, and

these rarer minerals offer much information regarding the conditions of formation of associated minerals.

In all cases, the first product of enrichment was chalcocite. This mineral occurs throughout the deposit but is most widely distributed through the porous sericitic rock along the western edge. In the central area of the deposit, rare occurrences of supergene(?) chalcopyrite older than chalcocite occur in massive chalcocite. This chalcopyrite is in the form of rounded, scattered grains.

Much of the chalcocite, probably most of it, formed through reactions of copper sulphate and pyrite and is found today very intimately associated with this sulphide. It has been estimated⁸ that it would be necessary to crush the Chuquicamata ore to four microns in order to release enough chalcocite to make a 90% recovery by flotation, and obtain a 65% copper concentrate.

Along the east side of the deposit, in the area to the northwest and in the vein zone northeast of the present pit, cuprite formed intimately associated with native copper. Associated with these minerals along the east side is tenorite and manganese oxides forming a "copper pitch ore." No satisfactory reaction can be given for the formation of this minor occurrence. Whatever the cause, the one feature evident in the field is that these oxide minerals and the native copper formed in an environment that was less acid than that of the great bulk of the supergene minerals. Most writers believe that native copper and cuprite form from essentially neutral or alkaline solutions. In the northwest the cuprite formed from veins carrying primary carbonates.

Another occurrence of native copper and minor cuprite intimately associated with specularite has been discovered by drilling along the eastern edge of the deposit. The shape and extent of this deposit were not delineated but the mass is essentially tabular, elongated parallel to the length of the main deposit. A feature of the occurrence is the intimate association of specularite and native copper with minor cuprite in cubic crystals. Some iron oxide is present but is not abundant. More detailed knowledge of the occurrence is necessary before the origin can be established. It may represent the formation of cuprite and copper after chalcocite through the action of ferric sulphate in a neutral environment or the specularite may be involved in the origin.

Cuprite forms after and from native copper at Chuquicamata. Characteristically the copper occurs as small to minute grains scattered through the cuprite, or, as mentioned above, the cuprite occurs as crystals on native copper. The massive cuprite occurs as kernels or veins surrounded by "copper pitch" and this, in turn, by chrysocolla and opal. Along the

⁸ Bandy, Private report, 1931. See Taylor, *op. cit.*

extreme eastern side of the deposit the "copper pitch" occurs in pure masses, round to tabular in shape. Some of the round masses are three feet in diameter. The ore is black with pitch-like luster in the center and grades to a soft dark brown mass on the border. This material is discussed under the name "Copper Pitch." Cuprite is also present as a late supergene mineral, pseudomorphic after antlerite. This will be discussed later.

In the bulk of the deposit at Chuquicamata the hypogene sulphides were deposited as small veins and disseminations through the "quartz-sericite," "normal rock" and to a minor degree in the "transition rock" types. These sulphides have weathered deeply except in areas of intense quartz flooding. In this part of the deposit the sequence relationships are clearer, and some of the oxidation reactions are more obvious than around the outer fringe.

The difficulty of oxidizing enargite is well known. The reason for the deep alteration at Chuquicamata is believed to be due to the disseminated character of the enargite as mentioned above, and to the abundance of associated pyrite. The latter mineral furnished the necessary iron (ferric?) sulphate, which could attack the small and isolated grains and small veins of enargite more effectively than large massive veins. It would appear that ferric sulphate rather than ferrous sulphate is involved in the oxidation of enargite with the formation of arsenate minerals. While arsenate minerals are not unknown at Chuquicamata, on the whole they may be considered as rather rare. There are a few isolated areas where chenevixite occurs. The weathering of the great mass of enargite at Chuquicamata has released a large quantity of arsenic, and whether this arsenic was carried away during the Tertiary period in solution or was fixed in the outcrops during this period as some arsenate mineral and then removed by the post-Pliocene erosion cannot be determined.

With the oxidation of the enargite, pyrite and minor covellite, the copper was carried downward and deposited from acid sulphate solutions on other pyrite and enargite as chalcocite. The replacement proceeded inwardly, and bladed enargite structures are preserved in some of the supergene chalcocite. This supergene chalcocite was later altered to oxide minerals. As a rule, the first mineral to form from the chalcocite and pyrite is chalcantite, and in near-surface areas chalcantite and kroehnkite, $\text{CuNa}_2(\text{SO}_4)_2 \cdot 2\text{H}_2\text{O}$. Field evidence indicates that kroehnkite formed from less acid solutions than chalcantite. With an adequate supply of water these minerals would go into solution and pass downward as copper sulphate in ferric sulphate solutions. Upon encountering

chalcocite, free from pyrite or with only minor amounts, covellite might form first from the chalcocite and, in turn, alter to antlerite. Many sections of chalcocite show a band of coarsely bladed covellite between the antlerite and the chalcocite. The band of covellite advances into the chalcocite as the antlerite vein widens.

The excess of sulphuric acid developed during the formation of antlerite and the ready oxidation of ferrous sulphate probably is the reason for the general absence of cuprite and native copper at Chuquicamata, as both of these agents readily attack those minerals. Studies of artificial minerals have shown that antlerite forms from relatively concentrated solutions. Some of the free acid is removed by the attack on ever-present pyrite and less commonly on covellite, and on other minerals in the deposit. The attack on the pyrite would develop ferrous and ferric sulphates in place, due to the lack of solutions to carry them downward to a permanent water table. With little water, there is a constant recrystallization and little migration of newly formed salts. With the influx of additional water, sufficient to cause solution, such solutions would be concentrated after a very short migration, and minerals, antlerite in this case, would precipitate from the concentrated solution.

The formation of antlerite, $\text{Cu}_3(\text{SO}_4)(\text{OH})_4$, at Chuquicamata and other Chilean deposits, and of brochantite, $\text{Cu}_4(\text{SO}_4)(\text{OH})_6$, at almost every other basic copper sulphate deposit the world over (except at the Antler Mine in Arizona, the type locality) may be explained by the special conditions of acidity of the solutions at Chuquicamata. The characteristic feature of almost all the Chilean deposits is the presence of abundant soluble sulphates throughout the deposits with an excess of available acid. Specimens from these mines, when placed in water, will usually yield a solution containing free acid. By analogy, water entering these deposits would soon contain free sulphuric acid which would attack less soluble salts and in this manner rapidly increase the amount of material in solution. It is well known that the presence of limestone in a deposit tends to retard migration of sulphates through the removal of free acid from the solutions in the deposit and in fixing the sulphates as insoluble or difficultly soluble minerals. In contrast, at Chuquicamata little acid is removed in this manner; instead it forms soluble salts and much of the acid is readily available by resolution in water carrying oxygen.

In deposits elsewhere in the world, much of the sulphur is not fixed in the oxidized portion of the deposit but is carried downward to the water table. Thus any copper sulphates formed above the water table in these deposits would be deposited from dilute solutions as regards

content of both base and acid, except in rare or isolated cases. Tunell and Posnjak⁹ worked with a portion of the system $\text{Fe}_2\text{O}_3\text{-CuO-SO}_3\text{-H}_2\text{O}$ and their data support this theory. They found that brochantite formed from dilute solutions, solutions with a concentration less than,

CuO	SO ₃	H ₂ O
0.61	0.64	98.75

Antlerite formed from solutions with a concentration greater than,

CuO	SO ₃	H ₂ O
5.01	5.22	89.77

The antlerite is the end point in the copper enrichment at Chuquicamata. After forming, it is removed and carried downward in solutions containing iron sulphates with the precipitation of iron oxide either as a hydrate mineral or as hematite. The boxwork of the iron oxide after antlerite is believed to be characteristic of the mineral, and certainly the iron oxide itself is. It is known locally as "maroon oxide" and has a very distinctive deep red color and texture. Whatever the intermediate composition of the "maroon oxide" pseudomorphic after antlerite is, during the oxidation process, it changes eventually to a brown limonite which is stable.

Some of the ore at Chuquicamata shows the rare relationship of cuprite replacing antlerite. The pseudomorphs retain the fibrous structure of the antlerite in minutiae. The chemistry of this replacement is not clear. It probably results from the reduction of the antlerite by ferrous sulphate with a delicate balance in the proportion of ferrous sulphate to antlerite. These pseudomorphs occur only on the eastern side of the ore body in areas of low acidity.*

Four other minerals of uncommon or rare, but genetically significant occurrence at Chuquicamata are chrysocolla, brochantite, azurite and malachite. Chrysocolla is rare in the southeastern section of the deposit. It is confined to the "low acid" areas. The writer has found brochantite (identified optically) in this same area associated with gypsum. It also occurs in the northwest area associated with gypsum. As pointed out earlier, the study of artificial minerals showed that brochantite forms from more dilute solutions than antlerite, and one would expect to find more dilute solutions in these areas.

Malachite and azurite occur in an outlying vein to the south of the deposit. The gangue of the ore is coarse, bladed specularite and minor

⁹ Tunell and Posnjak, *J. phys. Chem.*, vol. 35, p. 929, 1931.

* By "low acidity" the writer refers to areas characterized by oxide minerals and few or no sulphates. At Chuquicamata low acidity areas are "more or less coincident with the Transition Rock type."

magnetite. Chrysocolla is an abundant mineral in this vein. The amount of malachite and later azurite is insignificant in proportion to other copper minerals, but significant in indicating the environment of deposition of these and associated minerals. The carbon dioxide in these minerals was probably derived from a small amount of carbonate gangue in the vein. It should be noted that gypsum is a near-surface mineral at Chuquicamata and is a most abundant mineral in the fringe of the deposit and in the alluvium about the mine. The bulk of the gypsum was not derived from the ore deposit, however.

Atacamite was an abundant mineral at Chuquicamata in the early years of the mine. This basic copper chloride, $\text{Cu}_4\text{Cl}_2(\text{OH})_6$, formed from the action of surface waters, charged with sodium chloride, on the soluble copper salts. The mineral is practically limited to the upper 70 feet of the deposit. It is more abundant in the "low acid" areas.

The massive iron sulphate veins in the northeast area of the mine should be mentioned briefly. The pyrite is oxidized first to halotrichite, $\text{FeAl}_2(\text{SO}_4)_4 \cdot 24\text{H}_2\text{O}$, and then in successive steps to fibroferrite, $\text{Fe}_2(\text{SO}_4)_2(\text{OH})_2 \cdot 9\text{H}_2\text{O}$, hohmannite, $\text{Fe}_2(\text{SO}_4)_2(\text{OH})_2 \cdot 7\text{H}_2\text{O}$, amarantite, $\text{Fe}_2(\text{SO}_4)_2(\text{OH})_2 \cdot 6\text{H}_2\text{O}$, botryogen, $\text{MgFe}(\text{SO}_4)_2(\text{OH}) \cdot 7\text{H}_2\text{O}$, and jarosite, $\text{KFe}_3(\text{SO}_4)_2(\text{OH})_6$, with an introduction of Al_2O_3 , MgO , etc. The age relationships of botryogen are not clear. This mineral may be earlier than amarantite.

In other veins, probably veins that contained less primary pyrite or smaller veins, possibly areas of unusually strong dissemination of pyrite, metasideronatrite and metavoltine in intimate association, fibroferrite, ungemachite and clino-ungemachite and alums occur. These veins are not associated with the fibroferrite-amarantite veins and apparently the chemical or physical conditions of formation of the two associations were different. Almost all the minerals in these veins are soda-iron sulphates or soda-rich equivalents of potash-iron sulphates. The sequence is,

<i>Late</i>	Alums (soda)	$\text{Na}_2\text{Al}_2(\text{SO}_4)_4$	$24\text{H}_2\text{O}$
	Ungemachite	$\text{Na}_6\text{K}_2(\text{SO}_4)_4$	$8\text{H}_2\text{O}$
	Metasideronatrite	$\text{Na}_4\text{Fe}_2(\text{SO}_4)_4(\text{OH})_2$	$3\text{H}_2\text{O}$
	Ferrinatrite	$\text{Na}_4\text{Fe}_2(\text{SO}_4)_5$	$7\text{H}_2\text{O}$
<i>Early</i>	Metavoltine	$(\text{K}, \text{Na})_2\text{Fe}_2(\text{SO}_4)_4$	$7\text{H}_2\text{O}$

The alums are principally mendozite with a very small amount of kalinite, the potash alum.

This association represents an important feature of many deposits of northern Chile and especially of Chuquicamata. In this deposit, potassium sulphates are rare although the host rock is potash-rich. When the sulphates were formed, there was evidently an abundant source of

sodium that was taken up by the solutions moving down from the surface through the deposit. In every case, soda-rich minerals formed, such as natrojarosite, ungemachite, clino-ungemachite, or compound sodium sulphates such as those mentioned above. Corresponding potassium minerals did not form, while the sodium minerals mentioned above, as well as bloedite, mirabilite, kroehnkite and natrochalcite (the latter known only from this deposit) are common. This might well be called a "sodium province."

Two sources of the sodium can be postulated. One source is the sodium removed from the granodiorite during sericitization and orthoclazation. This sodium might have been carried upward to some horizon above the present deposit and there deposited as a sodium salt, possibly natroalunite, that would break down readily under weathering conditions. The one important point against this source is the presence of kroehnkite, metasideronatrite and metavoltine in other Chilean deposits. The second source is the abundant soluble sodium minerals in the alluvium over almost all of northern Chile. These minerals include halite, soda niter, mirabilite, and thenardite, salts believed by the writer to be of volcanic origin. All of these minerals occur about the deposit at Chuquicamata today and have certainly been present since the volcanism of the Pliocene and probably since the early Tertiary. The writer has found lenses of nitrates, chlorides and borates in early Jurassic beds in this vicinity. Any circulating ground water would carry sodium in considerable quantity, and rain falling on the surface over the deposit would be charged with this element. On encountering iron and copper minerals or solutions of iron and copper sulphates, the sodium would form compound sulphates with these elements. The preponderance of sodium minerals in the oxide zones of ore deposits in northern Chile has never been sufficiently stressed. This second source of sodium seems the more likely.

Oxidation at Quetena, Chile

A study of the oxidation at Quetena adds little to the data obtained from Alcaparrosa and Chuquicamata. At the surface, near the contact with the limestone, float pieces of limestone are being replaced by brochantite and gypsum. These minerals occur in shells about the limestone. The association—carbonate, gypsum and brochantite—is similar to that at Chuquicamata. The basic hydrous copper chloride, atacamite, occurs at the surface and gives way in depth to bandylite and this mineral, in turn, to the normal chloride, antofagastite. The sequence of formation is,

<i>Late</i>	Atacamite	Basic
	Bandylite	Normal
<i>Early</i>	Antofagastite	Normal

If chlorides and sulphates follow the same general sequence in oxidation, can it be true that other classes of minerals follow it also? The carbonates do at Chuquicamata in the one specimen of malachite with later azurite examined by the writer. Both are basic carbonates, but malachite is the more hydrous. However, this relationship between malachite and azurite is not universal, as one mineral is later than the other in one deposit, and the reverse is true in other deposits. An outstanding example of malachite after azurite is found in the fine specimens from Tsumeb. It should be noted, however, that the Tsumeb ores are in a limestone and dolomite gangue and would not be entirely comparable to occurrences like Chuquicamata. At Tsumeb, as at many mines, azurite does form after some of the malachite. At Bisbee, malachite is both earlier and later than azurite, but the great bulk of the azurite is apparently later than the greater amount of the malachite. This same relationship is true at Chessy, France. At Clifton-Morenci, Lindgren¹⁰ states that azurite "is often the latest mineral formed." Lindgren also states that malachite follows brochantite at Clifton-Morenci, an identical relationship to that found at Chuquicamata. From these data the writer believes that the tendency for the carbonates to follow the general sequence of the sulphates is probable. Carbonates are most abundant, of course, in deposits in limestone. The sulphate sequence is established from deposits in a country rock that does not react to any appreciable extent with the oxidizing solutions.

No data are available for considering the other classes of minerals. The oxides, phosphates, arsenates, vanadates, etc., offer an interesting field of study in this connection.

An excellent example of the sequence relationships at Quetena is afforded by the specimen shown in Figure 3. The central core is composed of a mass of individual crystals of halotrichite, szomolnokite and pyrite. The minerals of the succeeding bands and the mineral sequence are tabulated below.

<i>Late</i>	Pickeringite	Normal
	Limonite	—
	Pisanite	Normal
	Botryogen	Basic
	Jarosite with alternating bands of copiapite	Basic
	Parabutlerite	Basic
	Copiapite	Basic
	Halotrichite	Normal
	Szomolnokite	Normal
<i>Early</i>	Pyrite	

¹⁰ Lindgren, *U. S. Geol. Survey, Prof. Paper* 43, p. 118, 1905.

It is to be noted that normal cupriferous minerals, such as pisanite, form after basic pure iron sulphates. This occurrence of copper minerals after iron minerals checks the work done by Tunell and Posnjak¹¹ on the system $\text{Fe}_2\text{O}_3\text{-CuO-SO}_3\text{-H}_2\text{O}$, since they show that when there is any appreciable concentration of iron in the solution, that is, Fe_2O_3 present in quantities greater than 0.01%, iron sulphates rather than copper sulphates form. A solution with the following composition:

Fe_2O_3	0.22%
CuO	0.94
SO_3	1.64
H_2O	97.20

formed a precipitate of $\text{Fe}_2\text{O}_3 \cdot \text{H}_2\text{O}$ and $3\text{Fe}_2\text{O}_3 \cdot 4\text{SO}_3 \cdot 9\text{H}_2\text{O}$. It is evident that the copper is held in solution until the iron content falls to a trace, and then copper salts begin to form. In some parts of Quetena, cuprocopiapite formed by replacing copiapite, but only after copiapite, parabutlerite and jarosite had been formed. The same relationship is true at Chuquicamata.

PART II. DESCRIPTIVE MINERALOGY

The minerals are described under the same classification and in the same serial order as in Dana's "System of Mineralogy," sixth edition. Several new minerals are described and these are placed in serial order. The minerals, fully described, are treated in the following order:

Crystallography
Forms
Structure Cell
Habit
Twinning
Cleavage
Physical Properties
Optical Properties
Composition
Pyrognostics
Occurrence and Sequence
References

Some species are described and discussed as a group as well. An attempt has been made to clear up some of the doubtful species that have come from the area described as well as species that are directly related to this study from other areas.

Minerals that are of slight importance to the study and minerals upon which no new data have been obtained are treated briefly. Minerals seen

¹¹ *Op. cit.*

only as essential constituents of the local country rocks are not included. Most of the new minerals described herein have been given names except where it was felt that they were not as yet adequately described.

An alphabetical list of the minerals described or discussed is given in the index.

NATIVE ELEMENTS

Sulphur

A few veinlets of sulphur were observed in the field in a small specimen at Chuquicamata. During the detailed study of the Chuquicamata suite, a number of magnificent, although minute, crystals of sulphur were found in one specimen. The specimen contained abundant dehydrated pisanite, chalcantite, rare crystals of kroehnkite, sulphur and cuboid natrojarosite in twinned crystals. The minerals are named in the order of their formation. The sulphur crystals were essentially spherical in shape and covered with faces. One crystal, less than a millimeter in diameter, was measured and found to have 120 faces. Two crystals showed 26 of the 34 known forms for sulphur. The known forms not observed were: (210) (120) (023) (337) (335) (553) (551) (344).

Ungemach¹* described similar crystals from the sulphate deposit at Alcaparrosa, Tierra Amarilla, Chile. These crystals were found on roemerite associated with lapparentite. Sixteen forms were observed.

The origin of the sulphur is an unsolved problem. Sulphur in ore deposits has been reported for a few mining camps of the Western United States, Monte Poni, Sardinia, and Mexico. Sulphur has also been reported from the Wheatley Mine, Pennsylvania. With the exception of Tierra Amarilla and Chuquicamata, all the ore deposits that have sulphur in the supergene zone are lead deposits. The origin of the sulphur in the Chilean deposits probably involves different processes than those that were active in the lead deposits. In Chile the sulphur was probably formed by the action of chlorides or hydrochloric acid on acid sulphates. Hydrochloric acid will precipitate sulphur from solutions of acid sodium sulphate.

REFERENCE. ¹ Ungemach, M. H., *Bull. Soc. Fran. Min.*, vol. 58, p. 97, 1935.

Copper

Native copper is rare at Chuquicamata as a natural mineral and is not known at Quetena. At Chuquicamata it occurs as residuals in cuprite and as small slugs or irregular masses in the southeast section of the deposit. The latter occurrence is in a somewhat tabular but ill-defined zone where the copper is associated with cuprite and much

* References are given at the end of each species.

specularite. The area was encountered during churn-drill prospecting and little is known regarding it. It is possible that the copper has resulted from the reaction between specularite and copper sulphate solutions with the result that iron sulphate formed and copper was precipitated. This assumes that the copper is supergene. As far as known, it occurs only in the transition rock, in an area where sulphates give way to silicates, oxides, and chlorides. Possibly some reaction involving chloride solutions may have given rise to the native copper.

In many of the old mines that have been worked to the water level, fluctuations of the water-table level have flooded the lower workings at different times. The waters are acid and charged with copper, and now all the available iron left in the mines has been replaced by spongy masses of native copper.

Gold

Gold is reputed to have occurred in quantity to the north of the present open pit at Chuquicamata. Repeated panning and assaying of the gravel and crushed quartz from this area has failed to reveal even a color. Nevertheless, old workings of the indigenes extend to depths of more than 75 feet. Their only interest could have been gold. There are a few spotty occurrences of gold along narrow fractures to the west of Chuquicamata but not in commercial quantities

SULPHIDES AND SULPHO-SALTS

Molybdenite

MoS₂ Hexagonal

Molybdenite occurs in plates and crystals at Chuquicamata in the northwest area, associated with primary chalcopyrite and bornite. It formed earlier than either of these sulphides.

As the open-pit mining extended to the west, the appearance of molybdenum in the ores and solutions at Chuquicamata caused a great deal of trouble in the mill. The molybdenum acted as a catalytic agent and prevented the precipitation of copper in the electrolytic plant. Thousands of mine samples were assayed for molybdenum, and the metal was found to be limited roughly to the western half of the deposit. The actual mode of its occurrence was not known, but it was believed to be present as "molybdic ocher." In 1932 the writer¹ recognized that the molybdenum was associated with narrow interlacing quartz veins on the western side of the deposit. These veins formed a rock type that had been mapped as "lacing veinlets." A number of assays of the vein material proved it to be comparatively high in molybdenum. The study

of about a hundred polished sections of these veins failed to give any positive proof of the exact state of the molybdenum in the veins, as all were oxidized and the amount of molybdenum present was usually less than 0.5%. Only occasional specks of a dark gray mineral gave any hint of the original mineral. The gray mineral had a hardness of four and gave etch tests that do not agree with any known mineral. The writer believes the mineral to be an iron-molybdenum sulphide.

REFERENCE. ¹ Private report, 1932. See Taylor, *op. cit.*

Chalcocite

Cu₂S Orthorhombic

Chalcocite is widespread at Chuquicamata and rare at Quetena. At the former mine it occurs as a supergene mineral to depths of over 2,000 feet, replacing pyrite and enargite. There is evidence of chalcocite zones formed at different elevations at Chuquicamata and, while some may have existed in pre-Tertiary times, the more distinct zones were formed in Tertiary times. Chalcocite occurs in all forms from disseminated grains to pure veins of massive sulphide up to eight inches wide. "Sooty" chalcocite is common on exposed surfaces in the abandoned mines, but most of this is a mixture of covellite and chalcocite. Much of the massive chalcocite is very pure, yielding less than 0.5% impurities upon analysis. No crystals have been observed.

The sequence relationships are shown in Table I.

Sphalerite

ZnS Isometric

Sphalerite has been reported by Berkey and Kerr¹ in the veins of the outlying mines. The writer has never been able to definitely identify this mineral at Chuquicamata.

REFERENCE. ¹ Private report, 1931. See Taylor, *op. cit.*

Covellite

CuS Hexagonal

Covellite is both a hypogene and supergene mineral at Chuquicamata and is rare as a supergene mineral in "sooty" chalcocite at Quetena. At Chuquicamata the hypogene covellite is latter than enargite in formation and was introduced following, or during, a period of fracturing. Much of it, especially in the outlying veins, shows apparent deformation, but this may be due to replacement of deformed enargite. The hypogene form is never in coarse blades as in much of the supergene material. It is widespread as both a hypogene and supergene mineral, but is never abundant. The sequence relationships are,

Supergene	<i>Late</i>	Sulphates, etc. Covellite Chalcocite Chalcopyrite
Hypogene	<i>Early</i>	Covellite Enargite

*Bornite*Cu₅FeS₄ Isometric

Bornite occurs at Chuquicamata as a rare mineral except in isolated points in the outlying fringe of veins at the north and east of the deposit. In these veins it occurs as a hypogene mineral replacing chalcopyrite. Subsequent to its formation, fracturing occurred and enargite was introduced, which replaced both the bornite and chalcopyrite. As a supergene mineral, bornite is very rare at Chuquicamata. It has been observed in small, sharp cubes associated with chalcocite. The age relationships of the supergene mineral are not known.

*Chalcopyrite*CuFeS₂ Tetragonal

Chalcopyrite is rare at Chuquicamata as both a hypogene and supergene mineral. It has been mentioned by almost everyone who has written about Chuquicamata as an important ore mineral. Actually, the hypogene variety is confined to the outer fringe of veins. It is most abundant in the northwest area, but it also occurs in veins to the north and east of the deposit, associated with bornite. It is very rare as a supergene mineral associated with chalcocite. The sequence relationships are,

Supergene	<i>Late</i>	Chalcocite, etc. Chalcopyrite
Hypogene		Enargite, etc. Bornite Chalcopyrite Molybdenite Pyrite

*Pyrite*FeS₂ Isometric

Pyrite is an abundant mineral at all three deposits. At Chuquicamata it occurs in grains and crystals up to one-half inch on the edge. The best crystals are found in vugs in the pyrite roots of the enargite veins. Here small brilliant cubes occur with euhedral quartz in a massive quartz-pyrite gangue.

There are several ages of pyrite at Chuquicamata, probably three and

possibly four, two or three of the pyrite periods preceding the copper sulphides. Some of the massive pyrite veins of the northeast area were comparatively free from copper mineralization and, upon weathering, have yielded abundant iron sulphates.

At Quetena and Alcaparrosa pyrite occurs as unaltered grains enclosed in sulphates. There is some associated chalcocite at Quetena that has blackened the pyrite, but at Alcaparrosa bright angular grains of pyrite occur in crystals of szolmnokite, halotrichite and rhomboclase.

"Cupriferous pyrite" is a term commonly used in descriptions of Chuquicamata, as well as other deposits of the Andes. This is a very misleading term as many writers have pointed out.

Arsenopyrite

FeAsS Orthorhombic

The occurrence of arsenopyrite at Chuquicamata might be expected, but it has never been positively identified. One specimen of massive arsenopyrite came to the hands of the writer and was described as coming from an outlying vein. A wide search of the area failed to show any additional material, so the occurrence was never checked to the writer's satisfaction.

Tetrahedrite

Cu₃SbS₃ Isometric

Tetrahedrite was reported by Berkey and Kerr in a private report, 1931, in ores from the Panizo Vein. The writer has found specks of a gray mineral in other outlying veins, and this may be tetrahedrite but it has never been definitely identified. This unidentified mineral shows the following age relationships,

Hypogene	<i>Late</i>	Enargite
		Unknown (tetrahedrite?)
		Bornite
	<i>Early</i>	Chalcopyrite

Enargite

Cu₃AsS₄ Orthorhombic

Enargite, part of it the variety luzonite, is the primary ore mineral at Chuquicamata. It occurs as coarse bladed masses in veins up to a meter or more in width in the fringe zone and from veins of this magnitude down to disseminated grains less than a millimeter across in other parts of the deposit. There is a rough zonal distribution of the enargite as related to physical size. As one moves east from the west fissure, the enargite passes from fine-grained disseminations to larger and larger veins with less and less disseminated material. Crystals are rare and show

only the common forms. The coarsest enargite found at Chuquicamata comes from the lower levels of veins farthest to the east.

Enargite replaces pyrite, bornite and chalcopyrite and is in turn replaced by covellite and supergene sulphides and sulphates. There is a close parallel in the occurrence of enargite at Chuquicamata and Butte, Montana. In both camps the enargite occupies the central area, and chalcopyrite and bornite occur outside the main mass of the enargite.

HALOIDS

Halite and other chlorides are common in the soil throughout northern Chile. In the vicinity of these three deposits and especially at Chuquicamata where alluvium is more abundant, halite, gypsum and nitrates are found in disseminated grains, crystals and lenses. These minerals occur in the alluvium at varying depths up to several meters but usually less than a meter. There are more or less continuous openings at these depths that are lined with crystals and crystalline aggregates. The openings are roughly tabular in shape, very irregular and rarely over a foot thick. In walking over the ground, these openings give a faint drum-like sound. The origin of these salts is believed to be volcanic and the openings are probably due to solution and possibly to some extent to buckling of the superincumbent material by crystallization of the salts.

Halite

NaCl Isometric

Halite occurs widespread in the surface material about these deposits. It occurs in grains, crystals and aggregates and is found in the deposits themselves as well. The halite has been the source of the chlorine that has combined with copper to form atacamite and other chlorides so abundant in these deposits. Alcaparrosa is an exception in that only halite has been identified from there.

Bandylite

$\text{CuB}_2\text{O}_4 \cdot \text{CuCl}_2 \cdot 4\text{H}_2\text{O}$

This mineral is one of a number of new species first found by the writer in Chile, and later studied by him and others at Harvard University and the U. S. National Museum.¹

Crystallography: Tetragonal, ditetragonal-dipyramidal, $a:c = 1:0.9070$. Forms: $c(001)$, $a(010)$, $m(110)$, $d(012)$, $e(023)$, $f(011)$, $g(021)$, $o(112)$, $p(111)$, $q(221)$. Common forms: c , p , g , m . Structure cell, a_0 6.13, c_0 5.54, contains $\text{CuB}_2\text{O}_4 \cdot \text{CuCl}_2 \cdot 4\text{H}_2\text{O}$. Habit often tabular (001), frequently irregular with large pyramidal development. Cleavage (001) perfect and easy, producing thin flexible plates. $H = 2\frac{1}{2}$. $G = 2.810$. Color deep blue with greenish lights. Streak pale blue to white. Uniaxial negative, ω 1.691, ϵ 1.641. Pleochroism in blue with $\omega > \epsilon$.

	ANALYSIS OF BANDYLITE		
	1	2	3
Cu	34.94	.5498	35.74
CaO	0.05		
MgO	0.05		
Na ₂ O	0.40		
K ₂ O	none		
Fe ₂ O ₃	0.35		
Cl	19.47	.5490	19.94
B ₂ O ₃	23.35	.2715	24.08
CO ₂	0.05		
H ₂ O	19.60	1.0888	20.24
Insol.	1.84		
Total	100.10		100.00

1. Mina Quetena, near Calama, Chile. Analyst, W. F. Foshag.
2. Molecular ratios.
3. Calculated composition for $\text{CuB}_2\text{O}_4 \cdot \text{CuCl}_2 \cdot 4\text{H}_2\text{O}$.

Occurrence: Occurs near the surface at Mina Quetena, west of Calama, Chile, associated with antofagastite and atacamite on rusty quartz.

REFERENCE. ¹ Palache and Foshag, *Am. Mineral.*, vol. 23, p. 85, 1938.

*Antofagastite*¹

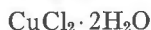

The natural occurrence of this common laboratory product was first found by the writer.

Orthorhombic, dipyramidal, $a:b:c=0.9177:1:0.4631$.¹ Forms:² $c(001)$, $b(010)$, $a(100)$, $m(110)$, $t(520)$, $q(103)$, $r(101)$, $s(301)$, $p(111)$. Common forms: b , m , t . Structure cell: a_0 7.38, b_0 8.04, c_0 3.72, contains $\text{Cu}_2\text{Cl}_4 \cdot 4\text{H}_2\text{O}$.³ Crystals commonly curved. Cleavage $m(110)$ perfect, $c(001)$ good. Brittle. Fracture conchoidal. $H=2\frac{1}{2}$. $G=2.4$. Color bluish green to greenish blue with sometimes a yellowish tinge.

Biaxial positive, $2V=75^\circ$, $r < v$; $\alpha=b=1.646$ =bright green, $\beta=c=1.685$ =olive green, $\gamma=1.745$ =pale blue.

Analysis	1.	2.
Cu	36.89	37.22
Fe ₂ O ₃	0.20	
CaO	0.15	
MgO	0.04	
Cl	40.68	41.52
H ₂ O	20.81	21.26
Insol.	0.95	
Total	99.72	100.00

1. Mina Quetena, Calama, Antofagasta, Chile. W. F. Foshag, analyst.
2. Composition for $\text{CuCl}_2 \cdot 2\text{H}_2\text{O}$.

Occurrence: Found near the surface at Mina Quetena, west of Calama, Chile, associated with bandylite and atacamite. These chlorides occur in a leached zone above the massive iron sulphates.

Copper chlorides are rare in nature, atacamite and the rare chloride nantokite being the only ones known heretofore. As stated above, at Quetena this new chloride is associated with atacamite and the new copper borate-chloride bandylite. Antofagastite was the first mineral to form, followed by bandylite, with atacamite last. In the mine these minerals are associated with heavily iron-stained vuggy quartz veins. Antofagastite extends to the greatest depths, while abundant atacamite occurs within a foot of the surface and decreases in amount with depth. The sequence relationships of the three minerals are very clear in the field.

REFERENCES. ¹ Palache and Foshag, *Am. Mineral.*, vol. 23, p. 85, 1938.

² Forms (100) (103) (101) on artificial crystals only. See Groth, *Chem. Krist.*, vol. 1, p. 238, 1906.

³ Harker, *Zeits. Krist.*, vol. 93, p. 136, 1936.

Atacamite



Orthorhombic, dipyramidal— $2/m \ 2/m \ 2/m$, $a:b:c=0.6617:1:0.7535$,¹
 $p_0:q_0:r_0=1.1387:0.7535:1$.

New Forms	No. of Crystals	Measured		Calculated	
		ϕ	ρ	ϕ	ρ
370	3	32°37'	90°00'	32°56'	90°00'
012	1	0 38	19 30	0 00	20 39
0.11.2	1	0 00	76 27	0 00	76 26
553	2	56 34	66 19	56 30½	66 17
232	2	47 07	58 12	45 13	58 04
143	2	21 14	47 15	20 42	47 02

Much of the atacamite at Chuquicamata and all the atacamite at Quetena occurs in long acicular crystals or in crystalline mats and radiating rosettes of prismatic crystals. A common habit at Chuquicamata is tabular, enormously extended on {010}. Strong vicinal development sometimes gives the crystals an axe-like shape.

Occurrence: At Chuquicamata atacamite is limited to the upper one hundred feet of the deposit. While erratic in its distribution, it is most commonly found, in quantity, in the upper portions of the more massive sulphide veins. It occurs in a pulverent maroon-colored iron-oxide matrix in the axe-like crystals and less commonly in matted masses of minute prismatic crystals. As a rule it occurs in areas that might be

called "low acid" as contrasted with the sulphate-rich or "high acid" areas; certainly it forms in areas of too low acidity to produce antlerite.

The place of atacamite in the general sequence is not clear, but its relations to a few associated minerals are definite. A common association is kroehnkite-atacamite-natrochalcite, named in order of formation from oldest to youngest. Kroehnkite is a normal hydrous mineral, while the other two are basic. The relationship of atacamite to the two other minerals is very intimate and there is considerable overlap in the periods of formation, with distinctly separate periods for kroehnkite and natrochalcite. Veinlets of atacamite cut turquoise at Chuquicamata and crystals occur on crystals of leightonite. It is commonly associated with chrysocolla and is always the earlier mineral.

At Quetena atacamite occurs with antofagastite and bandylite and is the youngest mineral of the three. It is limited to the upper twenty feet of the deposit now exposed. In all of these associations atacamite agrees with the general sequence outlined in Table I, but the gaps between some of the associated minerals may be so great that it is impossible to say with certainty that it always conforms to this sequence.

REFERENCE. ¹ Ungemach, *Bull. Soc. Min. France*, vol. 34, p. 148, 1911.

OXIDES

Opal

SiO₂·nH₂O Amorphous

Opal occurs at Chuquicamata only in association with chrysocolla. It apparently results from the lack of sufficient copper to form chrysocolla, as it occurs coating this mineral and grades into it. This relationship might be expected from the composition of the two minerals.

Cuprite

Cu₂O Isometric, plagiohedral

Cuprite occurs in a number of associations at Chuquicamata. Fibrous cuprite occurs after antlerite. The cuprite preserves the structure of the antlerite even to the chatoyance. Massive and crystalline cuprite occur after native copper. The crystals are simple cubes showing small octahedral and dodecahedral faces. The massive cuprite replaces copper and is commonly associated with "copper pitch." Cuprite is a rare mineral at Chuquicamata, occurring in the "low acid" areas about the central part of the deposit. It is most common along the east-central and south-east areas and in the northwest area. Fine specimens have been obtained from the veins outside the deposit to the northeast.

"Copper Pitch"

This is a translation of an old German term of doubtful value. It has been used at Chuquicamata to describe a pitch-like occurrence of copper and manganese oxides. For a time the material was called crednerite because an analysis showed it to contain about forty per cent of copper and manganese in equal amounts. It occurs in round masses up to three feet in diameter and in veins along the east side of the deposit. It varies widely in composition and grades in color and luster from a pitchy black in the center to a dull pulverent brown mass on the edges. Cracks through it are commonly coated with antlerite crystals. Polished sections of the material showed it to consist of varying proportions of tenorite, melaconite, pyrolusite and manganite. There is some chrysocolla associated with it as well as some opal (?). These minerals would account for the silica content of some specimens. The material also occurs in veins where it may have cuprite associated. The copper pitch always forms a shell about the cuprite. No attempt was made to differentiate this material farther. Hausmannite may be present, but the identification was questionable.

Hematite

Fe_2O_3 Rhombohedral

Hematite occurs along the eastern side of the deposit and in scattered veins and lenses throughout the batholith, near the roof. In the deposit it is more or less coincident with the transition rock type. It occurs in specular masses, sometimes as breccia filling. No measurable crystals were observed. It was probably introduced before the copper mineralization and was followed by magnetite. With associated magnetite it forms a series of lenses and irregular veins to the northeast of the present pit at Chuquicamata which appear to be a continuation of the more disseminated hematite in the deposit proper. The only alteration definitely associated with these lenses is a small amount of irregularly distributed epidotization. Hematite is earlier than magnetite and all stages of replacement of hematite by magnetite can be observed. At Quetena, hematite occurs in small pure masses in the flows about the pit.

Magnetite

FeFe_2O_4 Isometric

Magnetite may occur in small, almost pure masses at Chuquicamata, but in general it is a rare mineral, pseudomorphic after hematite. No crystals have ever been observed.

"Limonite"

Under the term "limonite" a number of iron oxides at Chuquicamata may be mentioned here. It is possible, in the field to differentiate the type of iron oxide formed through the oxidation of pyrite, high-grade copper ore, hematite, etc. These are given various names referring to the color of the oxide. The exact nature of these oxides has never been determined.

Many beautiful specimens of iridescent limonite have come from Chuquicamata, some in delicate imitative shapes of considerable beauty. An unusual form of iridescent limonite is that formed after gypsum. The gypsum commonly weathers to stringy stalactitic masses, and when this material is replaced by limonite it results in very striking and beautiful material.

CARBONATES

Dolomite

The veins in the northwest area carry some carbonate as a gangue. The material is very fine grained and it has never been definitely determined. An analysis showed it to consist of calcium and magnesium carbonate in somewhat varying proportions, the variability being too great for dolomite. It is probably a mixture of dolomite and calcite. Due to the rarity of magnesite in ore veins, it is doubtful if it is a mixture of magnesite and calcite.

Cerussite

Cerussite is the only lead mineral that has ever been identified at Chuquicamata. Lead minerals are unknown in the other deposits. The cerussite occurs in rare pockets in the central northwest area of the mine. The crystals range in size up to three millimeters and are associated with antlerite in fibrous masses. The antlerite is later than the cerussite. Due to the deep etching, the crystals were not measured.

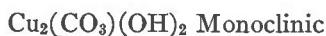
Malachite

Malachite is rare at Chuquicamata. One specimen was found in the southeast area of the deposit where the fibrous malachite was later than associated brochantite and earlier than associated azurite. Malachite, as well as all the other carbonates with the exception of cerussite, occurs in areas of "low acidity."

Azurite

Azurite occurs as a late mineral in the Mina Flor de Bosque at Chuquicamata. The associated minerals and the sequence relationships are,

<i>Late</i>		Chrysocolla Azurite Malachite
	Supergene	Brochantite
<i>Early</i>	Hypogene	Specularite

SILICATES

The rock-forming silicates will not be considered here. Only the unusual silicates, tourmaline and chrysocolla, will be mentioned.

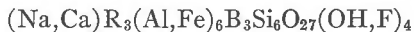
Tourmaline

Rhombohedral, hemimorphic

Tourmaline occurs in two forms at Chuquicamata. It is common near the roof of the batholith to the west of the deposit in minute radiating needles filling cracks in the granodiorite. Some of the minor veins of copper near the central part of the batholith, also near the roof, carry tourmaline as a vein mineral. Some of these veins are quite large, but the mineralization is weak and spotty.

To the north and west of the deposit in the country rock about the batholith, pegmatites of albite-tourmaline-titanite occur. The tourmaline is black to deep blue and replaces the albite. Rough crystals four inches in diameter can be found. The indices of the tourmaline are,

ω —dark brownish green—1.667

ϵ —light reddish brown—1.638

These indices would indicate a tourmaline with an iron oxide content of about 13%.¹

REFERENCE. ¹ Ward, *Am. Mineral.*, vol. 16, p. 145, 1931.

Chrysocolla

There are evidently a number of minerals that have been called chrysocolla and are hard to distinguish. There are at least three different minerals in the "chrysocolla" at Chuquicamata with different optical properties. It would be impossible to separate them and they never occur pure. These are all included here under the term chrysocolla.

The chrysocolla occurs in botryoidal, cyrptocrystalline masses in the extreme southeast portion of the deposit. The area is a "low acid" one and the most commonly associated mineral is atacamite, an earlier mineral. In some of the open vugs the chrysocolla grades into opal.

Sphene

CaTiSiO₅ Monoclinic

Sphene occurs in the tourmaline-albite-titanite pegmatites to the north of the deposit at Chuquicamata. It is in small, brilliant cinnamon-brown crystals rounded and etched. It would appear that the sequence in the pegmatite was,

<i>Late</i>	Tourmaline
	Titanite
<i>Early</i>	Albite

ARSENATES-PHOSPHATES

Chenevixite

Cu₂Fe₂(AsO₄)₂(OH)₄·H₂O

A mineral tentatively identified¹ as this species has recently been found at Chuquicamata, associated with enargite in the upper portions of the deposit. Crystals were not found. It is interesting chiefly as the only evidence yet found of the oxidation of enargite. Arsenates might well be expected to occur in abundance and variety.

REFERENCE. ¹ An analysis by the chemist of the Company showed a similarity with published analyses of chenevixite.

Turquoise

CuO·3Al₂O₃·2P₂O₅·9H₂O Triclinic

Turquoise was first identified at Chuquicamata in 1931 by the writer. It is rather common but is characteristically associated with the areas of "low acid," along the eastern side and at the northern end of the mine. It is almost always associated with specular hematite. The finest quality is a deep blue equal to the Persian material and can be cut and polished. From this deep blue, dense material it grades to an almost colorless, pulverent variety. Atacamite and antlerite are commonly associated with it, always later. At first the writer thought the mineral was primary, but now he believes it to be supergene. The source of the phosphorus is unknown. There is a large amount of phosphorus fixed in the turquoise. It is difficult to believe that this amount could have been derived from the alteration of apatite in the altered granodiorite, the source postulated by Pogue.¹ Boman² has described turquoise from both Calama and Antofagasta in beads.

REFERENCES. ¹ Pogue, *Mem. Nat. Ac. Sci.*, vol. 12, 1915.

² Boman, *Antiquites de la Region Andine de la Republique Argentine et du desert d'Atacama*, 1902, p. 766.

NITRATES

Soda Niter

NaNO_3 Rhombohedral

Soda niter occurs in massive aggregates in the upper portion of the deposit at Chuquicamata and in the alluvium surrounding all three deposits. Associated minerals are atacamite, bloedite and altered mirabilite. No sequence relationships can be given for these minerals. The soda niter is certainly earlier than the bloedite in specimens examined by the writer. The mineral is believed to be of volcanic origin.

BORATES

Ulexite

$\text{NaCaB}_5\text{O}_9 \cdot 8\text{H}_2\text{O}$ Monoclinic

Ulexite has been identified in the alluvium at Chuquicamata. It occurs associated with gypsum and halite in loose masses of fine silky fibers. Borax may also be present but it has never been positively identified. The borate-chloride bandylite, from Mina Quetena, is the only other boron-bearing mineral reported.

SULPHATES

Thenardite

Na_2SO_4 Orthorhombic

Thenardite occurs at Chuquicamata and Alcaparrosa as an alteration product of mirabilite. It has never been observed at Quetena. The mineral occurs as a fine-grained white powder. In northern Chile this mineral occurs in beds on the east side of the Central Valley, near Iquique. Many writers have noted it from this district. The total volume of the mineral is small. It is always a late, near-surface mineral, pseudomorphic after mirabilite.

Anhydrite

CaSO_4 Orthorhombic

Anhydrite occurs in the alluvium about Chuquicamata and, rarely at Quetena, associated with gypsum, halite and soda niter. It is not a common mineral, although it occurs in thick beds in the valley of the Rio Loa in the vicinity of these deposits.

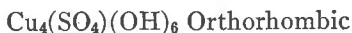
Brochantite

Brochantite is a comparatively rare mineral in the ore at Chuquicamata and Quetena. For many years the main ore mineral at Chuquicamata was called brochantite, but various people have studied the ore in laboratories and it has been recognized for some time that antlerite and not brochantite is the main ore-mineral. Brochantite occurs about the borders of the deposit in areas where the minerals formed from dilute solutions carrying a relatively small percentage of acid. Associated minerals are gypsum and chrysocolla. As stated before, brochantite is an early mineral, earlier than the rare malachite with which it may be associated. Another occurrence at Chuicamata is in the veins of the northwest area. These veins carry primary carbonates in the gangue. Brochantite is later than gypsum at Quetena.

Antlerite

It has been known for some time that the main ore mineral at Chuquicamata was not brochantite but antlerite.¹ The crystallography of antlerite has been studied by Professor Palache and the orientation changed from that of Ungemach² to conform to the orientation of brochantite and atacamite. Several new forms were observed on the crystals from Chuquicamata by Ungemach. Besides occurring as implanted crystals, antlerite forms well-defined cross-fibre veins cutting silicified rock.

Antlerite is the last step in the copper mineralization at Chuquicamata and a late mineral in the supergene sequence. Its place in the sequence may be seen in Table I A2 and A3. The vertical range of the mineral is great, ranging to depths of 1,000 feet. It usually forms as an oxidation product of chalcocite and covellite.

Several minerals have been described from Chile under different names that are actually varieties of antlerite. Stelznerite³ and heterobrochantite⁴ belong here.

REFERENCES. ¹ Andrieth and Martens, *Am. Mineral.*, vol. 10, p. 161, 1925.

² Ungemach, *Bull. Soc. Min.*, vol. 47, p. 1, 1924.

³ Thadeeff, *Zeits. Krist.*, vol. 31, p. 242, 1899.

⁴ Buttgenbach, *Bull. Soc. Geol. Belg.*, vol. 41, B 164, 1926.

Mirabilite

Mirabilite is common but spotty in occurrence in the upper portion of the deposit at Chuquicamata. It has not been observed at depths

greater than 60 feet, although it probably extends deeper than this. It has not been observed at Alcaparrosa and was only identified from its alteration product, a dehydration form, thenardite. The water in mirabilite is loosely held and goes off at 32.4°C.¹ In the arid climate of the Atacama desert, freshly broken surfaces of mirabilite have been studied and it was found that it required twenty seconds for a film of dull white thenardite, Na₂SO₄, to form over the mirabilite.

Mirabilite is difficult to place in the sequence at Chuquicamata and Alcaparrosa. At the former it is associated only with bloedite and occurs in the upper portions of the deposit. It is probably a late mineral and formed after the soluble iron sulphates had moved downward to lower levels. At Chuquicamata it occurs exclusively in the sericitic rock along the western side of the deposit. At Alcaparrosa it occurs with soda niter near the surface.

REFERENCE. ¹ Wuite, *Zeits. phys. Chem.*, vol. 86, p. 249, 1914.

Szomolnokite

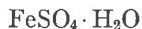

This mineral was first observed in 1891 by Krenner,¹ who named it from the type locality, Szomolnok, Hungary. Mackintosh² had, however, in 1889 analyzed an impure sample of the same mineral from Chile, but did not name it. In 1903 Scharizer³ analyzed pure szomolnokite associated with roemerite from Chile and erroneously named it "ferropalidite." In 1928 Krenner's posthumous paper by Zimanyi⁴ gave an analysis of material from the type locality, and a crystallographic discussion. Schaller⁵ later studied crystals from Utah and found that his data did not check well with Krenner's. The writer and others in the Harvard laboratory have again investigated the crystallography of this mineral, and have corrected Krenner's work. It was found that the positive and negative quadrants of Krenner are reversed from their proper position. Accordingly, Krenner's crystal has been redrawn (Fig. 4a), and a crystal of the Alcaparrosa szomolnokite with a very different habit is also given (Fig. 4b). This unusual habit, tabular (111), is very much like that of lazulite from Grave's Mountain, Georgia.

Since the habit of the crystals was so unusual it was thought at first that they were triclinic. However, the decisive measurement which established the true symmetry of the crystal was made by Professor Palache, who measured a crystal with [010] polar, that is, in the position of the second permutation. As neither pinacoid was present, the adjustment was made by using two pairs of faces of the forms (111) and ($\bar{1}\bar{1}\bar{1}$).

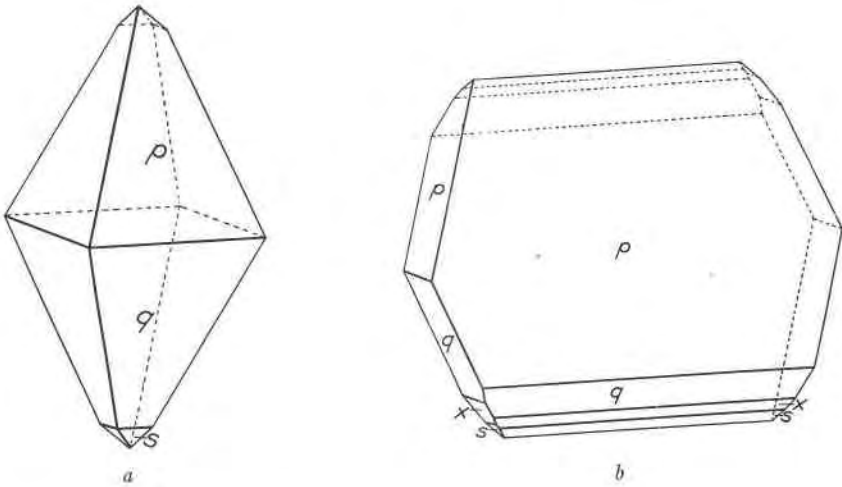

FIG. 4. Crystals of Szomolnokite.

The following table gives some of the measured and calculated values for the more prominent forms found in this study.

Form	No. of Observations	Measured		Calculated	
		ϕ	ρ	ϕ	ρ
$m(110)$	3	46°43'	90°00'	46°57'	90°00'
$t(012)$	3	1 18	42 10	1 31	42 08
$s(\bar{1}13)$	22	-45 31	40 35	-45 35½	40 44½
$x(\bar{1}12)$	20	-45 55	52 30	-45 58	52 27
$p(111)$	28	47 02½	69 21½	47 02½	69 21½
$q(\bar{1}11)$	28	-46 19½	69 06	-46 19½	69 06

An angle table for the species has been prepared by Professor Palache. In this table the new forms found by Dr. Schaller, as yet unpublished, are given, with his permission,* as well as the new forms found in the Harvard laboratory.

Monoclinic; prismatic— $2/m$

$$\begin{aligned}
 a:b:c &= 0.9344:1:1.8085 & \beta &= 91^\circ 22\frac{1}{2}' \\
 p_0:q_0:r_0 &= 1.9356:1.8080:1 & \mu &= 88^\circ 37\frac{1}{2}' \\
 r_2:p_2:q_2 &= 0.5531:1.0706:1 \\
 p_0' &= 1.9184, \quad q_0' &= 1.8085, \quad x_0' &= 0.0240
 \end{aligned}$$

* The angles of this table agree well with those observed by Schaller. Personal communication.

Forms	ϕ	ρ	ϕ_2	$\rho_2=B$	C	A
b^* 010	0°00'	90°00'	0°00'	0°00'	90°00'	90°00'
m 110	46 57	90 00	0 00	46 57	88 59½	43 03
t^\dagger 012	1 31	42 08	88 37½	47 53	42 07	88 59
u^* 023	1 08½	50 20	88 37½	39 41	50 19	89 07½
s 113	-45 35½	40 44½	121 36½	62 49½	41 44½	152 12½
x^\dagger 112	-45 58	52 27	133 05	56 33½	54 09½	145 15
n^\dagger 223	-46 08½	60 07	141 27	53 04½	61 07	141 08
p 111	47 02½	69 21½	27 14½	50 23	68 21	46 46½
q 111	-46 19½	69 06	152 10½	49 49½	70 06	132 30½
z^\dagger 137	-17 52½	39 09½	104 02	53 03	39 36	101 10½
w^\dagger 131	19 42	80 09½	27 14½	21 56	79 50½	70 36

* New forms, Schaller. †New forms, Bandy.

Habit: Pyramidal crystals, commonly distorted, tabular parallel to (111); parallel growth common.

Twinning: Twinning common, but twin laws not determined in this study.

Physical Properties: Fracture conchoidal, brittle. $G=3.05$. $H=2\frac{1}{2}$. Luster vitreous. Color, light shades of yellow, blue, red, brown, colorless.

Optical Properties:

n	
$\alpha=1.591$	Positive
$\beta=1.623$	$Y=b$
$\gamma=1.663$	$X \wedge c = -26^\circ$
	$2V=80^\circ$
	$r > v$, strong

Composition: hydrous ferrous sulphate, $FeSO_4 \cdot H_2O$.

Pyrognostics: B.B. light brown. Closed tube, yields acid water and black residue. Slowly soluble in water, yields brown solution.

Occurrence: Commonly associated with pyrite. Rare at Quetena. Szomolnokite apparently forms under arid conditions from solutions of high acid content and of high concentration. At Quetena it is intimately associated with halotrichite, a mineral to which it apparently alters. At Alcaparrosa it alters to roemerite and to rhomboclase. It is apparently the first mineral to form upon oxidation of pyrite, where there is no abundance of oxygen. With abundant oxygenated water, pyrite probably alters first to rhomboclase.

Relation to Kieserite: The new axial ratio here given for szomolnokite shows its close relationship to the corresponding magnesium mineral, kieserite.

	<i>a</i>	<i>b</i>	<i>c</i>	β
Kieserite	0.9147	1	1.7445	91°07'
Szomolnokite	0.9344	1	1.8085	91 23

The crystals of kieserite are similar to those of szomolnokite from the type locality. The optical orientation in the two minerals is likewise similar. No intermediate compositions have been recorded, however.

REFERENCES. ¹ Krenner, *Ak. Ertesitö, Budapest*, vol. 2, p. 96, 1891.

² Mackintosh, *Am. Jour. Sci.*, vol. 38, p. 245, 1889.

³ Scharizer, *Zeits. Krist.*, vol. 37, p. 547, 1903.

⁴ Zimanyi, *Centralb. Min.*, A, p. 268, 1928.

⁵ W. T. Schaller, *U. S. Geol. Survey*, unpublished.

Gypsum

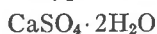

Gypsum is a common mineral in the alluvium about these deposits and occurs within the deposits themselves to some extent. In the alluvium the gypsum occurs in beds up to a foot or more in thickness. The beds are usually made up of fibrous gypsum, although rarely crystals have been found. In some of the old mines about the Chuquicamata deposit the walls of the workings may be coated with gypsum in curved forms. Commonly at Chuquicamata the gypsum is stained deep blue by copper sulphate. In the alluvium much of the gypsum is stained red with iron oxide.

The only sequence relationship that could be established showed the gypsum to be earlier than either antlerite or brochantite. Further to the east, in the Cerros de Sal, beds of coarse crystals of gypsum several yards thick overlie a thick bed of halite.

Epsomite

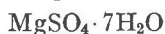

Epsomite occurs associated with other salts in the alluvium about the deposits. Further to the west, beds of epsomite four to eight inches thick are associated with pickeringite. About the deposits the epsomite is in white pulverent masses, commonly fibrous.

Melanterite

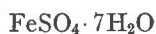

Melanterite has been reported from Alcaparrosa¹ associated with roemerite. This mineral was not encountered in this study, and there is a possibility that Frenzel confused fibroferrite with melanterite.

REFERENCE. ¹ Frenzel, *Min. Mitt.*, vol. 11, p. 221, 1890.

Pisante (Salvadorite)

The material described from Quetena¹ and called *salvadorite* differs in no important respect from *pisanite*, the iron-copper member of the melanterite group.² The following analyses show about a per cent more copper than that found in the original *pisanite*.

	1	2
FeO	8.49	9.59
CuO	18.77	17.57
SO ₃	27.87	28.16
H ₂ O	44.65	44.31
Total	99.78	99.63

1. Blue "salvadorite." 2. Green "salvadorite." 1-2 Herz, analyst.

Pisanite is a late mineral at Quetena forming, as a rule, after the iron sulphates have crystallized. This sequence is conformable with data obtained from the studies of the formation of artificial sulphates.

REFERENCES. ¹ Herz, *Zeits. Krist.*, vol. 17, p. 26, 1896 gave a prism measurement of 48°16', which is the complementary angle for the prism angle of *pisanite*.

² Powder photographs of melanterite and *pisanite* are not similar and a series probably does not exist between the two minerals. *Boothite* is the pure copper member of the group.

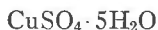
Chalcanthite

Chalcanthite is abundant at Chuquicamata and uncommon at Quetena today, although in years past it was an important ore mineral. At Chuquicamata it occurs in cross-fibre veins up to two inches wide. Occasionally vugs lined with crystals of *chalcanthite* are found, and small crystals are not rare in the north area of the deposit. A number of these crystals were measured and two new forms were observed.*

	Measured		Calculated		No. of Faces
	ϕ	ρ	ϕ	ρ	
<i>e</i> (121)	52°25'	59°28'	52°28'	59°19'	1
<i>h</i> ($\bar{1}22$)	-153 30	23 49	-153 33	23 53½	1

Chalcanthite occurs as both an early and a late mineral. At Chuquicamata one of the first sulphates to form from chalcocite is *chalcanthite*, closely followed in time by *kroehnkite*. It is apparent that these sulphates do not form from solutions carrying a high percentage of iron

* Elements of Tutton in the orientation of Kupfer.

sulphate, and thus form after much of the iron sulphate has been precipitated. It occurs in the upper portions of the "mixed ore" zone at Chuquicamata, a zone carrying both chalcocite and sulphates. Chalcanthite has not been definitely identified at Quetena, due to the difficulty of separating it from pisanite.

Bloedite



Bloedite is a common mineral at Chuquicamata and rare at the other deposits. At Chuquicamata it occurs most abundantly in the southwest area of the deposit and is limited to the upper 75 feet. It is usually in fibrous or granular veins and crusts. Crystals of good quality have never been observed. The common associated mineral is mirabilite or its dehydration product thenardite. Soda niter has been found with it, and atacamite is not rare in this association. It is often replaced by kroehnkite and leightonite. The age relationships with mirabilite and soda niter are not clear, but it is probably later than mirabilite. At Quetena it was observed in a crust, replaced by jarosite and replacing voltaite and coquimbite.

Picromerite

A mineral identified as picromerite on the basis of optical properties occurs in all three deposits. The indices of the material from Quetena were: $\alpha = 1.462$, $\beta = 1.464$, $\gamma = 1.471$; $r > v$; $2V$ large. The indices varied in the other deposits.

Picromerite occurs in white crusts of glistening crystals. It has the appearance of a mineral that has resulted from dehydration. There are several other white minerals of similar appearance found in these deposits, and some show minute and complex twinning.

At Chuquicamata this mineral is rather widespread, occurring most commonly with hohmannite, also with metavoltine and metasideronatriite. At Quetena it is commonly associated with botryogen and at Alcaparrosa with alums and massive pickeringite.

Leightonite

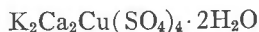

This mineral, long known to the geological staff at Chuquicamata, has been recently described by Palache.¹ The following abstract of its properties is taken from his paper.

Pseudo-orthorhombic (triclinic)

$$a:b:c=0.7043:1:0.4578; p_0:q_0:r_0=0.6500:0.4578:1$$

Forms	ϕ	ρ
<i>b</i> 010	0°00'	90°00'
<i>a</i> 100	90 00	90 00
<i>n</i> 130	25 19½	90 00
<i>m</i> 110	54 50½	90 00
<i>d</i> 031	0 00	53 56½
<i>e</i> 101	90 00	33 01½
<i>p</i> 111	54 50½	38 29
<i>q</i> 131	25 19½	56 39

The crystals are too poor for details of the triclinic form elements to be determined, but the nature of the lamellar twinning and optical properties make it certain that leightonite is triclinic. Twinning is probably parallel to (010) and (100) of the triclinic setting.

Peacock² was able to show that by a new setting of the triclinic mineral polyhalite, a homologue of leightonite, a close parallelism in the form of the two minerals became evident:

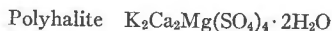

Triclinic: $a:b:c=0.7176:1:0.4657$

$\alpha=91^\circ39'$, $\beta=90^\circ06\frac{1}{2}'$, $\gamma=91^\circ53'$

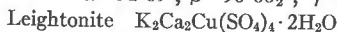

Pseudo-orthorhombic: $a:b:c=0.7043:1:0.4578$

$\alpha=90^\circ$, $\beta=90^\circ$, $\gamma=90^\circ$

Habit: Prismatic in flattened blades [001] the crystals commonly showing some curvature of macrodome faces, producing an hourglass-like appearance. It also forms cross-fibre veins up to one-half inch in width with kroehnkite and bloedite. The crystals reach a maximum length of 1 centimeter, generally much smaller.

Physical properties: No cleavage. Glassy fracture. $H=3$. $G=2.95$ (Berman).

Optical properties: (Berman) Color faintly blue to bluish green, transparent.

$$n(\text{Na}) \left. \begin{array}{l} \alpha=1.578 \\ \beta=1.587 \\ \gamma=1.595 \end{array} \right\} \text{all } \pm .002$$

Biaxial negative

$2V=65^\circ$

$r > v$ fairly strong

Extinction about 2° to

Y on sections parallel to (010)

Chemical composition:

	ANALYSES BY F. A. GONYER		
	1. Crystals	2. Massive	Calculated for the Formula $K_2Ca_2Cu(SO_4)_4 \cdot 2H_2O$
CuO	11.97	11.24	12.36
K ₂ O	13.93	13.62	14.66
Na ₂ O	0.56	0.98	
CaO	18.41	17.50	17.44
SO ₃	49.33	50.75	49.92
H ₂ O	5.71	5.98	5.62
Total	99.91	100.07	100.00

Occurrence: As bladed crystals on fractured rock surfaces and in cross-fibre veins. The following notes on the distribution of leightonite in the mine at Chuquicamata are taken from a letter written by O. W. Jarrell, a geologist on the mine staff. Leightonite occurs quite abundantly on the east and west sides of the open pit near the south end. It is limited to within about fifty yards of the original surface, below which it is not found. Thus it is nowhere found in the center of the present pit. Minerals found with it are chiefly atacamite and kroehnkite, never antlerite. It was found only under conditions of low acidity and hence is found generally in borderland material, never in rich ore.

Name: Leightonite is named in honor of Dr. Tomas Leighton, Professor of Mineralogy at the University of Santiago, Chile.

REFERENCES. ¹ Palache, *Am. Mineral.*, vol. 23, p. 34, 1938.

² Peacock, *Am. Mineral.*, vol. 23, p. 38, 1938.

ALUM AND HALOTRICHITE GROUPS

These groups are considered together because of their chemical similarity. The so-called isometric alums are usually inverted to lower symmetry forms, and the crystals now found are therefore pseudomorphs.

Isometric	Kalinite	$K_2Al_2(SO_4)_4 \cdot 24H_2O$
	Mendozite	$Na_2Al_2(SO_4)_4 \cdot 24H_2O$
	Mineral 42	Unknown
Monoclinic	Tamarugite	$Na_2Al_2(SO_4)_4 \cdot 12H_2O$
	Pickeringite	$MgAl_2(SO_4)_4 \cdot 22H_2O$
	Halotrichite	$FeAl_2(SO_4)_4 \cdot 22H_2O$

Kalinite (Potash Alum)

The mineral from Chuquicamata identified here as kalinite is isotropic with a refractive index of 1.455 and was not found in crystals. No biaxial

material was identified as kalinite or potash alum. This mineral is one of the few potash-bearing minerals to be found at Chuquicamata. It occurs there as a late mineral, later than natrojarosite and other iron sulphates. It is confined to the upper fifty feet of the deposit.

The mineral is much more abundant at Quetena. There it occurs with pisanite and jarosite. It forms both earlier and later than jarosite but is later than other copper and iron sulphates. Kalinite from there is always biaxial and varies somewhat from the indices given.¹

REFERENCE. ¹ Larsen and Berman, *Bull.* **848**, *U. S. Geol. Survey.*

Mendozite (Soda Alum)

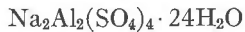

At Alcaparrosa and Chuquicamata, mendozite occurs in some abundance, and it is common at Quetena. In all of these places it is not isotropic,¹ and the white plates appear under the microscope as complex twins. The following optical data were obtained:

$$\beta = 1.466, \gamma = 1.472, X = b, Z \wedge \text{twin plane} = 40^\circ$$

Biaxial negative

Mendozite is a late mineral in the sequence and occurs after alunogen, with which it is easily confused. The sequence at Alcaparrosa is,

<i>Late</i>	Fibroferrite
	Mineral 42
	Tamarugite
	Mendozite
	Pickeringite
	Copiapite
<i>Early</i>	Metavoltine

The mineral occurs throughout the deposit but no crystals were observed.

REFERENCES. ¹ Dana (p. 951) states that the mineral often exhibits anomalous double refraction.

Mineral 42

This mineral occurs at Alcaparrosa as tiny brilliant yellow, transparent crystals with well-developed faces conformable with isometric symmetry, but an optical examination revealed an inversion, so that the crystals are now made up of anisotropic aggregates. The forms found include the cube, dodecahedron, trapezohedron, and the octahedron, the latter in excellent faces.

H = $2\frac{1}{2}$. G = 1.80. Only the mean refractive index (1.583 to 1.588) was determined, since the biaxial segments were too small to make a com-

plete optical study possible. The axial angle is large, and abnormal interference colors were visible.

The mineral occurs along the contact of tamarugite and the iron sulphates, metavoltine and copiapite. If it is an alum, it may be a soda-iron member.

The sequence is,

<i>Late</i>	Fibroferrite Mineral 42 Tamarugite
<i>Early</i>	Mendozite

Tamarugite



Tamarugite was originally described from northern Chile,¹ and later again analyzed from Chile.² The mineral has been analyzed from St. Bartholomew,³ Grotto del Zolfo⁴ and Gascogne River, Australia.⁵ Since the agreement between the analyses is good, the species seems well established.⁶

	ANALYSES		
	1	2	3
Na ₂ O	9.04	8.64	8.86
CaO	0.20		
Al ₂ O ₃	14.48	14.66	14.58
SO ₃	45.66	45.48	45.70
Cl	0.12	0.48	
H ₂ O	30.86	31.40	30.86
Total	99.36	100.66	100.00

1. Iquique, Northern Chile. Schulze, anal.¹
2. Grotto del Zolfo, Cap Miseno. Zambonini, anal.⁴ Includes 1.12% hygroscopic water.
3. Theoretical composition for Na₂Al₂(SO₄)₄ · 12H₂O.

The optical properties determined on material from the three deposits of this study are slightly variable and differ somewhat from the values given in the literature.⁷ One set of observations gives:

$$\begin{aligned} &\text{Biaxial positive } 2V = 60^\circ \\ &\alpha = 1.488, \beta = 1.491, \gamma = 1.500 \end{aligned}$$

Tamarugite occurs associated with various alums and is always a late mineral, usually later than the alums.

REFERENCES. ¹ Schulze, *Verh. Naturw. Deutsch. Ver. Santiago*, vol. 2, p. 56, 1889.

² Domeyko, *Mineralogía*, 2nd App., p. 30, 1883.

³ Cleve, *Svenska Vet. Ak. Handlingar*, vol. 9, p. 12, 1870.

⁴ Zambonini, *Ac. Sc. Napoli, Rend.*, Dec. 1907.

⁵ Simpson *J. Roy. Soc. Western Australia*, vol. 9, p. 62, 1923.

⁶ The species has been omitted from recent editions of Ford's Dana Textbook of Mineralogy.

⁷ Larsen and Berman, *Bull.* 848, *U. S. Geol. Surv.*

Pickeringite



Hitherto nothing was known with certainty as to the crystallography of this mineral. The data contained in the following tables are therefore new and are based on the measurement of many crystals. These were slender needles (Fig. 5) and the terminal faces were excessively small, but the data are well established and the crystal setting is confirmed by an *x*-ray study.

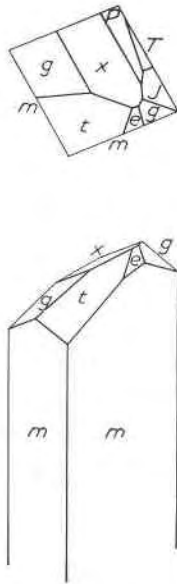

FIG. 5. Crystal of Pickeringite.

TABLE 1. ANGLE TABLE—PICKERINGITE

Monoclinic

$a:b:c=0.8655:1:0.2551$	$\beta=96^{\circ}33\frac{1}{2}'$
$p_0:q_0:r_0=0.2948:0.2534:1$	$\mu=83^{\circ}26'$
$r_2:p_2:q_2=3.9459:1.1638:1$	
$p_0'=0.2967, q_0'=0.2551, x_0'=0.1150$	

Forms	ϕ	ρ	ϕ_2	$\rho_2=B$	C	A
<i>b</i> 010	0°00'	90°00'	—	0°00'	90°00'	90°00'
<i>a</i> 100	90 00	90 00	0°00'	90 00	83 26½	0 00
<i>m</i> 110	49 18½	90 00	0 00	49 18½	85 02	40 41½
<i>n</i> 210	63 26	90 00	0 00	63 26	84 08½	26 34
<i>w</i> 011	24 16	15 38	83 26½	75 46½	14 13½	83 38½
<i>x</i> 021	12 42	27 36½	83 26½	63 07½	26 52½	84 09
<i>y</i> 031	8 33	37 44	83 26½	52 45½	37 14½	84 47
<i>z</i> 041	6 26	45 45½	83 26½	44 36½	45 23½	85 24
<i>d</i> 101	90 00	22 22½	67 37½	90 00	15 49	67 37½
<i>e</i> 301	90 00	45 09	44 51	90 00	38 35½	44 51
<i>D</i> 101	-90 00	10 28	100 28	90 00	17 01½	100 28
<i>E</i> 301	-90 00	37 47	127 47	90 00	44 20½	127 47
<i>p</i> 111	58 13	25 50½	67 37½	76 43½	20 32½	68 15
<i>q</i> 221	54 14½	41 07½	54 41	67 24	35 58	57 45
<i>P</i> 111	-35 27½	17 23½	100 18	75 54½	21 50	99 59
<i>Q</i> 221	-43 09½	34 58	115 34	65 17	39 42½	113 05
<i>S</i> 331	-45 21½	47 26½	127 46½	58 50	52 16	121 36½
<i>f</i> 121	38 54	33 15	67 37½	64 44½	29 31½	69 51½
<i>g</i> 131	28 16½	40 59½	67 37½	54 43	38 14½	71 53½
<i>F</i> 121	-19 36	28 26½	100 18	63 20½	31 12½	99 11½
<i>G</i> 131	-13 21½	38 11½	100 18	53 01½	40 08	98 12½
<i>H</i> 141	-10 06	46 01½	100 18	44 53	47 31	97 15
<i>i</i> 211	70 11½	36 58½	54 41	78 14½	30 52½	55 32
<i>j</i> 231	42 47½	46 12	54 41	58 01	41 57½	60 38½
<i>I</i> 211	-61 56	28 28	115 34	77 02½	34 23	65 08
<i>J</i> 231	-32 00½	42 04	115 34	52 23	45 49	69 12
<i>K</i> 241	-25 07	48 25	115 34	47 22½	51 27½	108 31
<i>r</i> 311	75 45½	46 02½	44 51	79 48	39 42½	45 45½
<i>t</i> 321	63 05	48 25½	44 51	70 12½	42 39	48 09½
<i>R</i> 311	-71 47	39 12½	127 46½	78 36	45 29	126 54½
<i>T</i> 321	-56 38½	42 51½	127 46½	68 02	48 26½	124 37
<i>V</i> 421	-64 32½	49 53½	136 59	70 48½	55 51½	133 40½

Table 2 gives the details concerning the distribution of forms on the eleven crystals measured, and shows the prominence of the various forms.

TABLE 2. COMBINATIONS ON PICKERINGITE

	1	2	3	4	5	6	7	8	9	10	11
<i>b</i> 010	x			x	x		x			x	
<i>a</i> 100					x		x				
<i>m</i> 110	x	x	x	x	x	x	x	x	x	x	x
<i>n</i> 210						x				x	
<i>w</i> 011					x		x			x	x
<i>x</i> 021					x			x			
<i>y</i> 031		x		x	x	x			x	x	
<i>z</i> 041						x					
<i>d</i> 101			x	x	x		x				
<i>e</i> 301				x			x	x	x		
<i>D</i> $\bar{1}01$							x			x	
<i>E</i> $\bar{3}01$						x	x		x		
<i>p</i> 111					x	x	x				x
<i>q</i> 221			x	x		x			x		x
<i>P</i> $\bar{1}11$	x					x	x	x			
<i>Q</i> 221					x		x			x	
<i>S</i> $\bar{3}31$							x				
<i>f</i> 121				x	x						x
<i>g</i> 131		x	x			x	x	x	x		x
<i>F</i> $\bar{1}21$					x	x	x				
<i>G</i> $\bar{1}31$					x	x	x			x	x
<i>H</i> $\bar{1}41$						x				x	
<i>i</i> 211	x			x	x	x	x				
<i>j</i> 231	x	x	x	x	x			x	x		x
<i>I</i> $\bar{2}11$					x	x					
<i>J</i> $\bar{2}31$	x									x	x
<i>K</i> $\bar{2}41$						x	x				x
<i>r</i> 311	x				x		x		x		x
<i>t</i> 321	x	x	x	x			x	x			
<i>R</i> $\bar{3}11$	x				x	x					
<i>T</i> $\bar{3}21$	x				x			x	x	x	x
<i>V</i> $\bar{4}21$	x										

Structure cell: Space group $P 2/m$; a_0 20.8, b_0 24.2, c_0 6.17, $\beta = 95^\circ +$.
 $a_0:b_0:c_0 = 0.860:1:0.255$; contains $Mg_4Al_8(SO_4)_{16} \cdot 88H_2O$.

Habit: In long acicular tufts; as a felted mass, and as closely packed cross-fibre veinlets. Also massive.

Physical properties: Cleavage (010) poor. Fracture conchoidal. Brittle. $H=1\frac{1}{2}$. $G=1.73$. Luster vitreous. Color white to yellow, sometimes brown.

Optical properties: Biaxial negative,

$$2V=60^\circ, Z \wedge c = +36^\circ, Y=b$$

$$\alpha_{Na}=1.475; \beta_{Na}=1.480; \gamma_{Na}=1.483$$

Chemistry: A hydrous magnesium aluminum sulphate $MgAl_2(SO_4)_4 \cdot 22H_2O$ corresponding to the iron compound halotrichite. The following is an analysis of the material used in this study.

PICKERINGITE (analysis by F. A. Gonyer)

Al ₂ O ₃	12.30
MgO	4.35
CaO	0.09
H ₂ O+	44.66
SO ₃	37.84
Insol.	0.50
Total	<u>99.74</u>

Relation of pickeringite to halotrichite: The two minerals form a series according to the formula

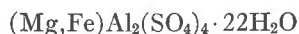

with analyses showing an apparently complete gradation between magnesium and iron. The following table shows their similarities in other respects.

CRYSTALLOGRAPHY

	X-Ray	Ratio
Pickeringite	a_0 20.8, b_0 24.2 c_0 6.17	0.8655:1:0.2551 $\beta=96^\circ 33\frac{1}{2}'$
Halotrichite	a_0 20.5, b_0 24.2 c_0 6.17	0.845:1:0.254 $\beta=100.6^\circ$

OPTICS

	α	β	γ	2V	Orientation
Pickeringite	1.475	1.480	1.483	60°	$Z \wedge c=36^\circ$ $Y=b$
Halotrichite	1.480	1.486	1.490	35°	$Z \wedge c=38^\circ$ $Y=b$

Occurrence: Pickeringite forms snow-white tufts of fibers on massive jarosite, together with chalcantinite and fibroferrite, as one of the last minerals to form at Quetena.

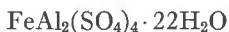
Halotrichite

Terminated crystals of halotrichite have never been found. However, the material of this study was in sufficiently distinct crystals for the requirements of an *x*-ray study with the Weissenberg goniometer. The crystallography here given, as well as the optical properties, and an analysis are new data for the species, and establish its close relationship to pickeringite, the magnesium member of the series.

Crystallography: Prism measurements on the needle-like crystals yielded forms and angles as follows:

Forms	Measured		Calculated		No. of Faces
	ϕ	ρ	ϕ	ρ	
<i>b</i> 010	0°00'	90°00'	0°00'	90°00'	19
<i>l</i> 250	24 43	90 00	24 12	90 00	4
<i>m</i> 110	49 18	90 00	48 20	90 00	38

The calculated angle is derived from the *x*-ray data given below.

Structure cell: Monoclinic; $a_0 = 20.47$, $b_0 = 24.24$, $c_0 = 6.167$; $\beta = 100.6^\circ \pm 1^\circ$. $a:b:c = 0.845:1:0.254$. Contains $\text{Fe}_4\text{Al}_3(\text{SO}_4)_{16} \cdot 88\text{H}_2\text{O}$.

Habit: Prismatic [001]; common forms *b m*; vertical zone striated [001]; crystals commonly acicular in radiating or matted aggregates, larger crystals commonly hollow [001].

Cleavage: (010) poor.

Physical properties: Fracture conchoidal, brittle. $G = 1.895$. $H = 1\frac{1}{2}$. Luster, vitreous; silky in fibrous aggregates. Colorless to light green.

Optical properties:

$n(\text{Na})$	
$\alpha = 1.480$	Negative
$\beta = 1.486$	$2V = 35^\circ$
$\gamma = 1.490$	$r > v$, medium
	$Z \wedge c = 38^\circ$ $Y = b$

Composition: An analysis on material used for the optical and *x*-ray study was made by F. A. Gonyer, as follows:

Al_2O_3	10.26
Fe_2O_3	0.65
FeO	7.28
$\text{H}_2\text{O}+$	43.33
SO_3	37.28
CuO	0.66
Insol.	0.93
Total	100.39

This is in good agreement with the formula.

Pyrognostics: Closed tube yields abundant acid water; B.B. decrepitate. Readily soluble in water and acids.

Occurrence: Occurs at all three deposits intimately associated with pyrite, szomolnokite and other iron sulphates.

Halotrichite is an early mineral, apparently forming directly from pyrite by action of solutions carrying aluminum sulphate. Occurs as an alteration product of szomolnokite. Apparently the presence or absence of aluminum sulphate determines whether szomolnokite or halotrichite forms. It occurs at Chuquicamata in crystals up to one-sixteenth of an inch thick in a groundmass of pyrite, sericite and aluminum sulphate.

C. Klauer¹ found that halotrichite only formed in iron aluminum sulphate solutions that contained an excess of sulphuric acid and, when the excess acid failed, precipitation ceased. The natural associations point to an excess of sulphuric acid at the time of formation of this mineral.

REFERENCE. ¹ Klauer, *Ann. f. Pharm.*, vol. 14, p. 261, 1835.

Coquimbite and Paracoquimbite

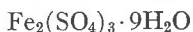

Coquimbite was first described from Chile,¹ where it is more abundant than in other described occurrences. Recently an exhaustive crystallographic study was made by Ungemach² on material from the type locality, with the conclusion that the mineral represents dimorphous forms, for one of which, the hexagonal form, the name coquimbite is retained, and the other, the rhombohedral modification, is called paracoquimbite. These two forms have been verified by the writer.

Analyses of the material of this study, are as follows:

	1	2	3
Fe ₂ O ₃	27.5	28.71	28.5
CuO	2.8		
CaO	1.5		
SO ₃	39.9	42.31	42.8
H ₂ O	28.4	28.82	28.7
Insol.		0.40	
Total	100.1	100.24	100.0

1. Chuquicamata. Bert Carter, Chile Exploration Co., analyst. Includes SiO₂, Al₂O₃, MgO trace.

2. Alcaparrosa. Deep amethystine color. E. P. Henderson, U. S. National Museum, analyst.

3. Theoretical for Fe₂(SO₄)₃ · 9H₂O.

Coquimbite is not a common mineral at Chuquicamata. It has been observed in several specimens, but it apparently disappears rapidly in depth.

Both coquimbite and paracoquimbite occur at Quetena, coquimbite being the more common in the specimens studied. It is commonly associated with voltaite, a later mineral. It is less commonly associated with szomolnokite, roemerite and quenstedtite. Both szomolnokite and roemerite are earlier minerals and the relationships with quenstedtite are not clear. The latter mineral appears to be the later. The coquimbite is always light in color.

Both coquimbite and paracoquimbite are abundant at Alcaparrosa, the rhombohedral modification, paracoquimbite, greatly predominating. The mineral ranges in color from a pale violet to a deep amethystine. Crystals up to three-quarters of an inch in size are present.

The sequence relationships of the mineral are given below,

<i>Late</i>	Lapparentite
	Quenstedtite
	Coquimbite
	Roemerite
<i>Early</i>	Szolmokite

An attempt was made to determine which modification was the earlier, the hexagonal or the rhombohedral. The data is conflicting but it is believed by the writer that the hexagonal coquimbite is the earlier form.

REFERENCES. ¹ Rose, *Pogg. Ann.*, vol. 27, p. 310, 1833.

² Ungemach, *Bull. Soc. Min.*, vol. 58, p. 165, 1935.

Kroehnkite



Kroehnkite is a common mineral in northern and central Chile and a rare mineral elsewhere in the world. In portions of the deposit at Chuquicamata it constitutes an ore mineral. Crystals are common, and it also forms cross-fibre veins. The largest crystal found measures one-half by one-quarter by three and one-quarter inches. The crystallography of kroehnkite in its present form was first established¹ after a study of crystals from Chuquicamata. In this study the following forms were observed: *a b m h e d q s w x*.

In the oxidation of chalcocite in the northern portion of the ore deposit at Chuquicamata, chalcantite is usually the first sulphate to form. This is followed by kroehnkite, and antlerite replaces the kroehnkite. Along the western side of the ore body, kroehnkite is characteristically associated with atacamite and natrochalcite. The deposition of pure kroehnkite was followed by the simultaneous deposition of kroehnkite and acicular atacamite. Toward the end of this period of deposition, atacamite began to crystallize in pyramidal crystals and continued to

form beyond the period of the kroehnkite. Natrochalcite forms crusts over these minerals and is definitely later. In the southern part of the deposit early bloedite is commonly replaced by kroehnkite.

REFERENCE. ¹ Palache and Warren, *Am. Jour. Sci.*, vol. 24, p. 342, 1904; *Zeits. Krist.*, vol. 45, p. 529, 1908.

Natrochalcite

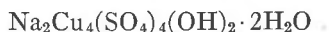

Natrochalcite is a rare mineral found only at Chuquicamata, in beautiful bright emerald-green crystals. The mineral was described in 1908.¹ It was limited to the upper portions of the deposit and in recent years has become increasingly rare. The mineral occurs coating cracks in the altered country rock or as crystalline crusts on kroehnkite and atacamite. Rarely it occurs in vugs in fibrous kroehnkite.

The paragenesis was incompletely determined in this study. A definite sequence was,

<i>Late</i>	Natrochalcite
	Atacamite
<i>Early</i>	Kroehnkite

No minerals were found coating the natrochalcite and nothing can be said regarding minerals that are later.

REFERENCE. ¹ Palache and Warren, *Am. Jour. Sci.*, vol. 24, p. 342, 1908; *Zeits. Krist.*, vol. 45, p. 529, 1908. The formula given above is a correction of that in the original paper.

Ferrinatrite



The mineral ferrinatrite was first described by Mackintosh.¹ Later the composition was verified by Genth² and Frenzel.³ Recently a mineral was found in Chile and named leucoglaucite by Ungemach,⁴ on the basis of a chemical analysis of a very small sample. In all other respects the mineral matches ferrinatrite closely. The mineral collected by the writer is similar in its physical properties to these two previously described minerals but differs from both chemically. The formulae derived from the analyses are:

(1) Ferrinatrite	$\text{Na}_3\text{Fe}(\text{SO}_4)_3 \cdot 3\text{H}_2\text{O}$
(2) Leucoglaucite	$\text{H Fe}(\text{SO}_4)_2 \cdot 2\text{H}_2\text{O}$
(3) Ferrinatrite-Bandy	$\text{Na}_4\text{Fe}_2(\text{SO}_4)_5 \cdot 7\text{H}_2\text{O}$

Since four analyses in good agreement have been made of ferrinatrite, the first of these formulae is the best established, on chemical grounds. Further, the three minerals are admittedly hexagonal, so that from structural considerations the first is also most likely since two molecular

weights of the first formula would give the proper number of atoms and molecular groups to distribute in hexagonal space groups. On the basis of symmetry the last formula is least suitable.

The following table lists chemical analyses and physical properties of the three minerals under consideration.

	Ferrinatrite				Ferrinatrite Bandy	Leuco- glaucite
	1	2	3	4	5	6
Na ₂ O	18.34	19.95	20.22	20.06	19.92	
K ₂ O	0.40	tr.			0.40	
CaO		0.22				
Fe ₂ O ₃	17.23	17.30	17.69	16.91	19.00	28.06
Al ₂ O ₃	0.43					
SO ₃	50.25	51.30	50.85	51.29	49.75	56.97
H ₂ O	11.14	11.89	11.90	11.50	15.13	15.02
Insol.	2.00				0.30	
Total	99.79	100.66	100.66	99.76	100.54	100.05
G		{ 2.547 2.578	2.61		2.57	2.52*
ω		1.558			1.557	1.559*
ϵ		1.613			1.615	1.627*
$a:c$			0.55278		0.5582	0.5589

* Determined on type material kindly sent by Professor Ungemach.

1. Ferrinatrite. Mackintosh, analyst.¹

2. Ferrinatrite. Genth, analyst.²

3. Ferrinatrite. Frenzel, analyst.³

4. Ferrinatrite. Scharizer, analyst.⁵

5. Ferrinatrite-Bandy. E. P. Henderson, analyst. Unpublished.

6. Leucoglaucite. Ungemach, analyst.⁴

Physical properties: The Chuquicamata ferrinatrite has G 2.57, H $2\frac{1}{2}$. Fracture splintery; fibers brittle. Cleavage $\{10\bar{1}0\}$ perfect. Color pale amethystine.

Habit: Prismatic to fibrous [0001], deeply striated. Often in parallel growths. Common forms: $b(11\bar{2}0)$, $p(10\bar{1}1)$.

Occurrence: As fibrous crusts associated with metasideronatrite and metavoltine at Chuquicamata. The former shows some evidence of replacing ferrinatrite and pseudomorphs have been observed. Metasideronatrite may be changed to ferrinatrite by treating with a solution containing an excess of sodium sulphate and sulphuric acid. This may account for the overlapping of the sequence of these two minerals since they seem to alter, one to the other, with ease, in both directions.

- REFERENCES. ¹ Mackintosh, *Am. Jour. Sci.*, vol. **38**, p. 243, 1889.
² Genth, *Zeits. Krist.*, vol. **18**, p. 586, 1891.
³ Frenzel, *Zeits. Krist.*, vol. **18**, p. 596, 1891.
⁴ Ungemach, *Bull. Soc. Min.*, vol. **58**, p. 97, 1935.
⁵ Scharizer, *Zeits. Krist.*, vol. **41**, p. 412, 1906.
 Scharizer, in Doelter, **4**[1], 582, 1929.

Metasideronatrite

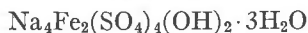

This mineral is newly described here. It differs from sideronatrite only in having less water, and consequently higher refractive indices and higher density. The relation between the two is shown below:

Formula	METASIDERONATRITE	SIDERONATRITE
	$\text{Na}_4\text{Fe}_2(\text{SO}_4)_4(\text{OH})_2 \cdot 3\text{H}_2\text{O}$	$\text{Na}_4\text{Fe}_2(\text{SO}_4)_4 \cdot (\text{OH})_2 \cdot 6\text{H}_2\text{O}$
G	2.46	2.2-2.3
α	1.543	1.508
β	1.575	1.525
γ	1.634	1.586
2V	60°	58°

Metasideronatrite can be produced from sideronatrite by dehydration over sulphuric acid. Whether the Chuquicamata material has gone through a dehydration is not certain, but no evidence of alteration is visible in the specimens, which are fresh, the cleavage flakes being quite transparent.

The minerals *urussite*¹ and *bartholomite*² are apparently related to the minerals here discussed, but the data are so meager that a decision concerning their nature cannot be reached.

Since this species is named here for the first time a complete description is given.

Crystallography: Orthorhombic; dipyramidal— $2/m \ 2/m \ 2/m$

$$a:b:c=0.4571:1:0.1187$$

$$p_0:r_0:r_0=0.2579:0.1187:1$$

$$q_1:r_1:p_1=0.4571:3.8598:1$$

$$r_2:p_2:q_2=8.4246:2.1877:1$$

Forms	ϕ	$\rho=C$	ϕ_1	$\rho_1=A$	ϕ_2	$\rho_2=B$
<i>b</i> 010	0°00'	90°00'	90°00'	90°00'	—	0°00'
<i>m</i> 110	65 26	90 00	90 00	24 34	0°00'	65 26
<i>e</i> 011	0 00	6 46	6 46	90 00	90 00	83 14

Forms	No. of faces	Measured	
		ϕ	ρ
<i>b</i> 010	10	0°00'	90°00'
<i>m</i> 110	21	62°48'–67°59'	90 00
<i>e</i> 011	2	89 49–89 58	6°44'–6°48'

Habit: Prismatic [001] crystals rare; usually in coarse to fine crystalline aggregates.

Cleavage: {100} {010} perfect, {001} eminent.

Physical properties: Fracture, fibrous; $G=2.46$; $H=2.5$. Luster, silky. Color golden yellow to straw yellow.

Optical properties:

$\alpha = a =$ colorless	$= 1.543$	Positive
$\beta = b =$ light yellow	$= 1.575$	$2V = 60^\circ$
$\gamma = c =$ brownish yellow	$= 1.634$	$r > v$, strong

Chemistry: Basic hydrous sodium-iron sulphate, $\text{Na}_4\text{Fe}_2(\text{SO}_4)_4(\text{OH})_2 \cdot 3\text{H}_2\text{O}$.

ANALYSIS BY E. P. HENDERSON

		Mol. Ratios	
Fe_2O_3	22.90	.1434	1.00
Na_2O	17.56	.2832	
K_2O	.26	.0028	1.99
SO_3	48.66	.6077	4.23
H_2O	9.75	.5411	3.77
Insol.	.60		
Total	99.73		

Insoluble in cold water. Soluble in boiling water with decomposition; soluble in dilute acids.

Pyrognostics: B.B. gives strong soda flame, colors bead dark brown. Closed tube yields abundant acid water. Insoluble in cold water.

Occurrence: At Chuquicamata intimately associated with metavoltine, less commonly with ferrinaitrite, ungemachite, alums and natrojarosite.

REFERENCES. ¹ Frenzel, *Min. Mitt.*, vol. 2, p. 133, 1879.

² Cleve, *Ak. Stockholm*, vol. 9, Nov. 1870.

Roemerite



The crystallography of roemerite has been variously interpreted. The final satisfactory setting of this triclinic mineral is that of Wolfe.¹ No crystals were encountered in this study, but roemerite is an abundant mineral at Alcaparrosa where it is associated with szomolnokite and rhomboclase during an early phase of pyrite oxidation. The following optical properties were determined on fresh material: $\alpha = 1.526$, $\beta = 1.564$, $\gamma = 1.575$; $2V = 50^\circ$; $r > v =$ extreme.

No analysis of material was made as the mineral commonly showed incipient alteration to coquimbite. The color was most intense and the mineral was purest in narrow halos about areas of pyrite and szomolnokite. In the change from roemerite to coquimbite the amounts of iron and oxygen remain the same, sulphur is added and water decreases in amount. At Quetena and Chuquicamata roemerite is a relatively rare mineral compared to coquimbite with which it is closely associated.

REFERENCE. ¹ Wolfe, *Am. Mineral.*, vol. 22, p. 736, 1937.

Metavoltine?

The writer has not been able to definitely identify the mineral here described. It approaches most closely the originally described metavoltine,¹ with, however, important differences. The mineral referred to metavoltine by Zambonini² is probably not really that species, nor is it related to the mineral here described. The artificial products of Scharizer³ and Gossner⁴ are undoubtedly of the same composition as Zambonini's mineral, but they are not metavoltine.

The crystallography of the material from Chuquicamata is contained in the following table:

		Hexagonal; dipyramidal— $6/m$ $c=2.5143$ $\rho_0=1.4517$				
Forms		No. of Faces	Measured		Calculated	
			ϕ	ρ	ϕ	ρ
<i>c</i>	0001	12	—	0°00'	—	0°00'
<i>a</i>	10 $\bar{1}$ 0	3	0°00'	90 00	0°00'	90 00
<i>b</i>	11 $\bar{2}$ 0	1	30 00	90 00	30 00	90 00
<i>p</i>	10 $\bar{1}$ 1	1	0 00	55 26	0 00	55 26
<i>l</i>	20 $\bar{2}$ 1	1	0 00	71 00	0 00	71 00
<i>c</i>	40 $\bar{4}$ 1	1	0 00	78 40	0 00	80 14
<i>e</i>	60 $\bar{6}$ 1	1	0 00	83 15	0 00	83 27

Habit: In aggregates of six-sided plates and scales; common forms: *o a*; crystals very rare; parallel growth [0001] common.

Cleavage: {0001} perfect

Physical properties: Fracture, rough and interrupted, plates slightly flexible; $G=2.5, 2.53, 2.396$. $H=2\frac{1}{2}$. $F=5$. Luster vitreous to oily.

Optical properties: Color olive green to greenish brown.

		n	
ω (brown)		1.589-1.590	Negative
ϵ (pale greenish yellow)		1.572-1.574	

Chemistry: In order to show the relation of the Chuquicamata mineral to metavoltine, as described, and to Zambonini's mineral, as well as the artificial material, a table of chemical analyses is given below:

ANALYSES OF METAVOLTINE AND RELATED MINERALS					
	1	2	3	4	5
Fe ₂ O ₃	21.20	21.03	23.31	22.03	21.54
FeO	2.92				
K ₂ O	9.87	21.49	4.69	21.22	21.44
Na ₂ O	4.65		8.15		
SO ₃	46.90	42.98	45.42	43.84	42.86
H ₂ O	14.58	14.35	17.83	21.91	14.49
Total	100.12	99.85	99.56	100.00	100.33
G	2.53		2.5	2.396	

1. Metavoltine. Blaas, analyst.¹ Persia.
2. Metavoltine? Zambonini, analyst.² Vesuvius.
3. Metavoltine? Henderson, analyst (Unpublished). Chuquicamata.
4. Artificial. Scharizer, analyst.³
5. Artificial. Gossner.⁴

The analyses given above indicate the following formulae:

- | | |
|----------------------------|--|
| (1) Metavoltine, Blaas | $K_4Na_3(Fe''Fe''')_6(SO_4)_{12} \cdot 16H_2O$ |
| (2) Metavoltine? Zambonini | $K_{10}Fe_6'''(SO_4)_{12}(OH)_4 \cdot 16H_2O$ |
| (3) Metavoltine? Henderson | $K_2Na_6Fe_6'''(SO_4)_{12}(OH)_2 \cdot 20H_2O$ |

Since the data at hand are not definite, no statement can be made concerning the validity of the formulae listed. Zambonini's material is most probably correctly formulated, since several analyses of similar artificial material are available.

General experience in sodium and potassium salts indicates that little isomorphism exists between them. Mixed crystals are usually not formed, so that the three substances here discussed may well be different minerals.

Pyrognostics: Partially soluble in water and dilute acids. On heating, the aqueous solution yields reddish precipitate. In closed tube yields water and forms black residue.

Occurrence: At Alcaparrosa metavoltine (?) occurs surrounded by a halo of copiapite in veins of pickeringite. The age relationships are metavoltine followed by copiapite with the pickeringite the younger mineral.

At Quetena metavoltine (?) is intimately associated with metasideronatrite, but the mineral is so uncommon that the age relationship was uncertain. Jarosite is later than the two minerals.

Metavoltine (?) is almost always associated, more or less intimately with metasiderontrite at Chuquicamata. The latter may occur without metavoltine, but in the writer's experience metavoltine (?) never occurs without associated metasiderontrite. With one exception, every occurrence appears to show the metavoltine (?) as the younger mineral. In a single specimen the metasiderontrite is certainly the younger mineral. Commonly associated with the two minerals are a number of members of the alum group such as kalinite, pickeringite, tamarugite. All of these minerals are normal sulphates and later than metavoltine (?) and metasiderontrite. Other associated minerals that are later are ungemachite and jarosite.

REFERENCES. ¹ Blaas, *Ab. Wien. Ber.*, vol. 87, p. 155, 1883.

² Zambonini, *Atti R. Acc. Napoli*, 8, 13, 1906.

³ Scharizer, *Zeits. Krist.*, vol. 58, p. 424, 1923.

⁴ Gossner and Arm, *Zeits. Krist.*, vol. 72, p. 205, 1929.

Copiapite and Cuprocopiapite

Copiapite is common in all three of the deposits studied here, and often as very fine small crystals. These crystals were studied by Professor Palache, who found the mineral to be triclinic, not orthorhombic or monoclinic as it had been previously regarded. The same conclusion regarding the symmetry of this mineral was simultaneously arrived at by Ungemach.¹

ANALYSES OF COPIAPITE

No.	β	Fe ₂ O ₃	SO ₃	H ₂ O	Na ₂ O- K ₂ O	MgO	FeO	CuO	Al ₂ O ₃	Insol.
1.	1.550	28.95	39.56	28.60		Tr.	.52		1.31	1.06
2.	1.546	30.75	39.28	29.97						
3.	1.545	29.98	39.68	30.45						.31
4.	1.543	23.21	38.44	27.76	.16		4.01	1.0	3.62	.52
5.	1.541	25.04	38.36	29.71		.29	.44		.31	5.43
6.	1.540	24.93	39.10	29.92	.40		.78		3.49	1.24
7.	1.538	24.96	37.92	31.51		3.10			.52	1.96
8.	1.535	27.44	39.47	27.84		3.26	.52			1.16
9.	1.532	26.10	38.37	30.68			4.06		Tr.	.71
10.	1.531	21.91	38.87	33.33			.94		4.15	.61
11.	1.530	26.25	39.24	28.32		3.47	1.04		.08	.48
12.	1.53	26.39	39.79	29.92		3.19				.30
13.	1.529	29.66	39.81	29.95			.33			.30
14.		27.28	39.83	29.92						.55
15.	1.591	27.66	41.62	23.51				5.72	1.47	.21
16.		26.8	33.5	29.0	.40	0.2		6.6		2.7

1. Atacama Desert, Chile. W. F. Foshag, analyst; unpublished.
2. Artificial. Posnjak and Merwin, *Jour. Am. Chem. Soc.*, vol. **44**, p. 1980, 1922.
3. Congo Mine, Perry Co., Ohio. Caughey, *Am. Mineral.*, vol. **3**, p. 162, 1918.
4. Island Mountain, Calif. W. F. Foshag, analyst; unpublished.
5. Leona Heights, Calif. W. F. Foshag, analyst; unpublished.
6. Temple Rock, Utah. W. F. Foshag, analyst; unpublished.
7. Laird Post, B. C. Todd, analyst; Walker, *Univ. Toronto Studies, Geol. Ser.*, vol. **14**, p. 84, 1922.
8. Blythe, Calif. W. F. Foshag, analyst; unpublished.
9. Capo d'Arco, Elba. Manasse, *Proc. verb. Soc. Toscana*, **1911**.
10. Vignera, Elba. Manasse, **1911**.
11. Las Vegas, N. Mex. W. F. Foshag, analyst; unpublished.
12. Santa Maria Mts., Calif. Schairer and Lawson, *Am. Mineral.*, vol. **9**, p. 242, 1924.
13. Copiapo, Chile. Manasse, **1911**.
14. Chuquicamata, Chile. F. A. Gonyer, analyst; unpublished.
15. Chuquicamata, Chile. Cuprocopiapite. F. A. Gonyer, analyst; unpublished.
16. Chuquicamata, Chile. B. W. Carter, analyst; unpublished.
On analyses 1, 4, 5, 6, 8, 11—refractive indices by Larsen, *Bull.* **679**, *U. S. Geol. Surv.*, 1921.

An attempt to correlate the refractive index (β) with the variations in composition of copiapites from Chile, and elsewhere, led to no conclusive results. In the following table is a list of analyses of copiapites, together with measurements of the β index. The writer is indebted to Dr. W. F. Foshag for the privilege of publishing here the six analyses credited to him.

Synthetic copiapite² yields a formula $\text{Fe}_4(\text{SO}_4)_5(\text{OH})_2 \cdot 16\text{H}_2\text{O}$. Analyses of natural copiapites vary considerably and the water content is frequently $18\text{H}_2\text{O}$. Analyses 7, 8, 11 and 12 are in good agreement with the formula



The cuprocopiapite composition (anal. 16) is most closely represented by the formula

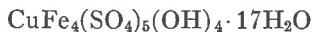

or, using analysis 15, the formula may be written

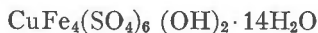

Occurrence: Copiapite is an abundant mineral in all three deposits. It is relatively most abundant at Alcaparrosa, where it occurs in thick layers of clear, brilliant crystalline aggregates. It may be used as a "key mineral" in the sequence study, as it is one of the earliest basic minerals, with the possible exception of fibroferrite.

Cuprocopiapite is always associated with copiapite, commonly with parabutlerite, chalcantite and jarosite. It is later than the first-men-

tioned two minerals and earlier than the last two. It is probably formed by the reaction between copiapite and sulphate solutions carrying copper. At Quetena it occurs in rounded masses, within massive iron sulphates, usually copiapite.

REFERENCES. ¹ Ungemach, *Bull. Soc. Min.*, vol. 58, p. 97, 1935.

² Posnjak and Merwin, *Jour. Am. Chem. Soc.*, vol. 44, p. 1965, 1922.

³ From unpublished results of M. Fleisher (1935) and M. A. Peacock (1938).

Quenstedtite

$\text{Fe}_2(\text{SO}_4)_3 \cdot 10\text{H}_2\text{O}$ Triclinic, pinacoidal

The crystal form of quenstedtite was first correctly established by Ungemach,¹ whose data we use. One new form on quenstedtite was observed in this study,

	Calculated		Measured	
	ϕ	ρ	ϕ	ρ
<i>u</i> 032	$21^\circ 44\frac{1}{2}'$	$29^\circ 17\frac{1}{2}'$	$21^\circ 20'$	$29^\circ 58'$

The mineral occurs in tabular crystals {010}. The color does not agree with that given by Linck² and Ungemach.¹ The material from Alcaparrosa is colorless to pale violet, differing from the "rose-lilas intense" color of the Copiapo material.

The optical properties of the Alcaparrosa material are tabulated below (as obtained in a measured crystal oriented on the Fedorov stage).

	ϕ	ρ	$n(\text{Na})$	
α	-43°	45°	1.547	Positive
β	128°	43°	1.566	$2V=70^\circ$
γ	-138°	88°	1.594	$r < v$ strong; horizontal
Extinction on (010) against [001] = 30° .				

Quenstedtite was only observed from Alcaparrosa. There it occurs intimately associated with coquimbite and lapparantite. In association with coquimbite it shows a remarkable case of replacement by alteration. Most of the quenstedtite is altered to coquimbite. Apparently the latter mineral forms earlier than quenstedtite but, due to the strong overlapping of their stability fields, both can form at essentially the same time. Within the range of the overlapping fields the quenstedtite alters readily to coquimbite through the loss of one molecule of water. Unaltered material occurs as crystal druses in the coquimbite and in rounded aggregates of minute crystals in copiapite.

REFERENCES. ¹ Ungemach, *Bull. Soc. Franc. Min.*, vol. 58, p. 97, 1935.

² Linck, *Zeits. Krist.*, vol. 15, p. 11, 1889.

Lapparentite

Lapparentite is a new mineral recently described by Ungemach¹ from Tierra Amarilla, Chile. This mineral was found at Alcaparrosa, near Cerritos Bayos, thus adding a new locality. It occurs in colorless tabular crystals, rather difficult to tell from quenstedtite with which it is commonly associated. All of the forms observed by Ungemach were found in this study with the exception of the base, and eight additional new forms were observed. It is to be noted that Ungemach found no orthodomies, and only the positive and negative unit orthodomies were observed in this study. The new forms are given below.

Forms	No. of Faces	Measured		Calculated from Ungemach's Ratio	
		ϕ	ρ	ϕ	ρ
140	4	39°53'	90°00'	40°41'	90°00'
150	3	34 07	90 00	34 31	90 00
160	4	30 05	90 00	29 49	90 00
180	2	23 32	90 00	23 16	90 00
1.12.0	2	16 15	90 00	16 00	90 00
101	2	89 42	42 34	90 00	42 27½
I01	1	-89 17	36 24	-90 00	36 44
I41(?)	1	-37 32	50 51	-37 41	50 40½

Optical properties: The optical properties for this species have not yet been recorded. Doctor Ungemach kindly furnished crystals of the original material, and the optical properties were determined on this as well as on crystals from the newer occurrence here given.

Biaxial positive.	$2V = 55^\circ +$
$\alpha = 1.490$	$Y = b$
$\beta = 1.492$	$X \wedge c = +5^\circ$
$\gamma = 1.504$	

At Alcaparrosa, lapparentite occurs in tabular crystals associated with quenstedtite in vugs in coquimbite and with pickeringite. Quenstedtite and coquimbite are earlier minerals, and pickeringite is later. However, some pickeringite appears to be earlier.

REFERENCE. ¹ Ungemach, *Bull. Soc. Franc. Min.*, vol. 58, p. 209, 1935.

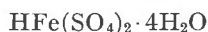
Rhombochase

This new species, recently described from Szomolnok, Czecho-

slovakia,¹ has been found by the writer at Alcaparrosa. This marks the second occurrence. Since the material available for this study was in good crystals, a complete redescription is here given. The crystallography has been amplified by a more complete form list and a more accurate axial ratio. The refractive indices have been determined. Several other physical properties have been measured.

Crystallography:

Orthorhombic; dipyramidal

$$a:b:c=0.5577:1:0.9370$$

$$q_1:r_1:p_1=0.5577:0.5952:1$$

$$p_0:q_0:r_0=1.6801:0.9370:1$$

$$r_2:p_2:q_2=1.0672:1.7930:1$$

Forms	Calculated		No. of Measurements	Measured		Krenner's Measurements		Krenner's Forms
	ϕ	ρ		ϕ	ρ	ϕ	ρ	
<i>c</i> 001	—	0°00'	11	—	0°00'			x
<i>b</i> 010	0°00'	90 00	10	0°00'	90 00			x
<i>s</i> 120	41 53	90 00	3	41 42	90 00			x
<i>m</i> 110	60 51	90 00	19	60 51	90 00	58°36'	90 00'	x
<i>t</i> 041	0 00	75 02	2	00 00	75 13			
<i>n</i> 118	60 51	13 31	3	60 56	13 01			
<i>r</i> 114	60 51	25 41	1	58 10	25 00			
<i>v</i> 113	60 51	32 40	3	58 00	31 00			
<i>w</i> 223	60 51	52 03	6	60 45	52 10			
<i>p</i> 111	60 51	62 32	10	60 51	62 32		62 38	x
<i>q</i> 221	60 51	75 26	5	58 00	75 28			
<i>u</i> 241	41 53	78 46	2	41 44	78 40			

Krenner's axial ratio is

$$a:b:c=0.5695:1:0.94644.$$

All the forms observed by Krenner were also found by the writer. Additional forms are given in the table.

Habit: Tabular {001}; base shows etch forms, common forms: *b c m p*.

Cleavage: {001}, perfect, {110}, excellent.

Physical properties: Fracture conchoidal to fibrous, cleavage folia are flexible and polished. G=2.23. H=2. Luster pearly to subvitreous. Colorless to gray.

Optical Properties:

	<i>n</i> (Na)	
α =[001]	1.534	Negative
β =[100]	1.553	2V=27°
γ =[010]	1.638	

Pyrognostics: Slowly soluble in water. Insoluble in NH₄OH but forms a brown coating over mineral (iron hydroxide?). Soluble in acids. B.B. decrepitates and fuses to a dark brown bead.

Occurrence: Rhomboclase occurs at Alcaparrosa, near Cerritos Bayos, intimately associated with szomolnokite and roemerite. It is believed to be later than either of these minerals. The formation of this mineral and a detailed description of the mineral relationships has been given in the section on geochemistry.

REFERENCE. ¹ Krenner, *Centralbl. Min.*, A, p. 265, 1928.

Parabutlerite



A basic hydrate of iron of this same composition has already been described as the mineral butlerite¹ and as an artificial compound² in the system $\text{Fe}_2\text{O}_3\text{-SO}_3\text{-H}_2\text{O}$. However, the mineral here called parabutlerite is orthorhombic, prismatic in habit; the artificial substance is presumably monoclinic;² the originally described butlerite has been erroneously assigned to the orthorhombic system but is really triclinic.

Parabutlerite, both by its crystallography and optical properties as given later, is definitely orthorhombic. Butlerite has been re-examined during this study, and the conclusion was reached that it is triclinic because microscopic examination shows a twin plane in the position (100) of Lausen's¹ orientation. The optical orientation within each individual is such that the most probable symmetry is triclinic.

The artificial compound is in diamond-shaped crystals with possible twinning on (30 $\bar{1}$) and (20 $\bar{3}$). This suggests the possibility that the artificial material may be the same as butlerite. Actual crystallographic measurements of the artificial substance were not included in the work cited, but the ratio and forms were given.

The following table compares the modifications here discussed.

TABLE OF COMPARISON

Symmetry	Parabutlerite Orthorhombic	Butlerite Triclinic (pseudo- orthorhombic)	Artificial Monoclinic
Ratio	$a:b:c=$ 0.7310:1:0.7218	0.9005:1:1.3606	0.858:1:1.358 $\beta=71^\circ 24'$
α	1.598	1.604	1.588
β	1.663	1.674	1.678
γ	1.737	1.731	1.749
G	2.55	2.548	
H	$2\frac{1}{2}$	$2\frac{1}{2}$	

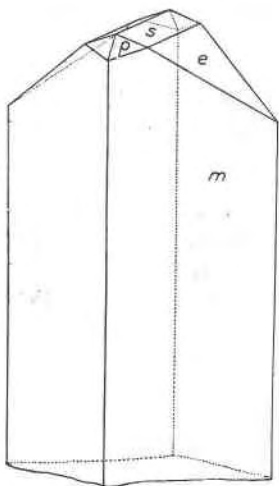

FIG. 6. Crystal of Parabutlerite.

The following full description of parabutlerite is given here since the mineral is first named and described in this study.

Crystallography: Orthorhombic; bipyramidal— $2/m\ 2/m\ 2/m$

$$a:b:c=0.7310:1:0.7218$$

$$p_0:q_0:r_0=0.9874:0.7218:1$$

$$q_1:r_1:p_1=0.7310:1.0128:1$$

$$r_2:p_2:q_2=1.3855:1.3680:1$$

Forms	ϕ	$\rho=C$	ϕ_1	$\rho_1=A$	ϕ_2	$\rho_2=B$
<i>l</i> 140	$19^\circ 30\frac{1}{2}'$	$90^\circ 00'$	$90^\circ 00'$	$70^\circ 29\frac{1}{2}'$	$0^\circ 00'$	$19^\circ 30\frac{1}{2}'$
<i>m</i> 110	53 50	90 00	90 00	36 10	0 00	53 50
<i>s</i> 012	0 00	$19\ 50\frac{1}{2}$	$19\ 50\frac{1}{2}$	90 00	90 00	$70\ 09\frac{1}{2}$
<i>f</i> 034	0 00	$28\ 25\frac{1}{2}$	$28\ 25\frac{1}{2}$	90 00	90 00	$61\ 34\frac{1}{2}$
<i>e</i> 011	0 00	35 49	35 49	90 00	90 00	54 11
<i>g</i> 032	0 00	$47\ 16\frac{1}{2}$	$47\ 16\frac{1}{2}$	90 00	90 00	$42\ 43\frac{1}{2}$
<i>d</i> 101	90 00	44 38	0 00	45 22	45 22	90 00
<i>p</i> 111	53 50	50 44	$35\ 49\frac{1}{2}$	51 19	45 22	62 49
<i>r</i> 212	$69\ 55\frac{1}{2}$	46 26	$19\ 50\frac{1}{2}$	47 07	45 22	75 36

Habit: Prismatic [001] (Fig. 6) common forms: *m s e p*; prism zone striated [001].

Cleavage: {110} poor.

Physical Properties: Fracture conchoidal, brittle. $G=2.55$. $H=2.5$.

Luster, vitreous.

Optical Properties: Color light orange to light orange-brown.

	$n(\text{Na})$	
$\alpha = b =$ pale yellow	1.598	Positive
$\beta = c =$ greenish yellow	1.663	$2V = 87^\circ$
$\gamma = a =$ brownish yellow	1.737	$r > v$, moderate

Composition: Basic hydrous iron sulphate, $\text{Fe}(\text{SO}_4)(\text{OH}) \cdot 2\text{H}_2\text{O}$.

ANALYSIS (Henderson, U. S. National Museum) ³			
	Per cent	Molecular Ratios	
Fe_2O_3	39.21	.2455	1.00
SO_3	39.15	.4889	1.99
H_2O	22.00	1.2210	4.97
Insol.	.23		
Total	100.59		

Pyrognostics: B.B. dark brown; closed tube, yields acid water; insoluble in water, hot or cold, ammonia, soluble in dilute acids.

Occurrence: Occurs at Alcaparrosa near Cerritos Bayos in a bed about 8 inches thick above copiapite. It results from the alteration of copiapite and in part is pseudomorphic after copiapite. It also occurs with copiapite and jarosite at Quetena and Chuquicamata.

All of the field evidence points to the conclusion that parabutlerite formed after copiapite. This evidence is conformable with the findings of Posnjak and Merwin² in their study of the system $\text{Fe}_2\text{O}_3\text{-SO}_3\text{-H}_2\text{O}$. At 50 degrees they found that these minerals formed from the following solutions.

COMPOSITION OF SOLUTION

	weight per cent			
	$\text{SO}_3/\text{Fe}_2\text{O}_3$	Fe_2O_3	SO_3	H_2O
$\text{Fe}(\text{SO}_4)\text{OH} \cdot 2\text{H}_2\text{O}$	2.55-2.69	17.96-20.13	22.96-27.18	59.08-52.69
Copiapite	2.74-3.66	20.70-16.78	28.40-30.72	50.90-52.50

Jarosite is later than parabutlerite. The definitely established sequence is:

Jarosite
Parabutlerite
Copiapite
Coquimbite

Much of the parabutlerite at Quetena and Chuquicamata is associated with copiapite and jarosite and shows the same sequence relationships as at Alcaparrosa. One specimen showed the parabutlerite as having formed during the formation period of copiapite at Quetena. Posnjak and Merwin obtained both the compound $\text{Fe}_2\text{O}_3 \cdot 2\text{SO}_3 \cdot 5\text{H}_2\text{O}$

and copiapite from a solution of the composition Fe_2O_3 , 21.0; SO_3 , 28.2; H_2O , 50.8.

REFERENCES. ¹ Lausen, *Am. Mineral.*, vol. 13, p. 203, 1928.

² Posnjak and Merwin, *Jour. Am. Chem. Soc.*, vol. 44, p. 1965, 1922.

³ Henderson, U. S. National Museum, unpublished data on the material of this study.

AMARANTITE GROUP

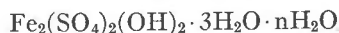

Hohmannite	$\text{Fe}_2(\text{SO}_4)_2(\text{OH})_2 \cdot 3\text{H}_2\text{O} \cdot 4\text{H}_2\text{O}$
Castanite	
Amarantite	$\text{Fe}_2(\text{SO}_4)_2(\text{OH})_2 \cdot 3\text{H}_2\text{O} \cdot 3\text{H}_2\text{O}$
Paposite	
Metahohmannite	$\text{Fe}_2(\text{SO}_4)_2(\text{OH})_2 \cdot 3\text{H}_2\text{O}$

The members of this group are brownish red basic hydrous iron sulphates, in one of which, amarantite, dehydration data¹ indicate that the water is given off in three stages. The three molecules most loosely held go off below 100° , the next most loosely held above 100° and below red heat, and the hydroxyl at a higher temperature. The formulae are, accordingly, written to indicate these various kinds of water. On dehydration, when exposed to air, hohmannite apparently loses the four loosely held molecules of water and forms what is here called metahohmannite. In this respect it differs from amarantite, which is much more stable under atmospheric conditions. At Chuquicamata a fresh surface of hohmannite alters on exposure in about twenty seconds.

Amarantite is characteristically found in radiating or matted acicular crystals. Hohmannite may be distinguished by the rapidity of its alteration, and metahohmannite is always a powdery alteration product.

A comparison of the optical properties of these three minerals is given below.

	Hohmannite	Amarantite	Metahohmannite
α	1.559	1.516	1.709
β	1.643	1.598	1.718
γ	1.655	1.621	1.734
2V	(-)40°	(-)30°	+
disp.	$r > v$ extreme	$r < v$	
Pleochroism	$\left\{ \begin{array}{l} X = \text{very pale yellow} \\ Y = \text{pale greenish yellow} \\ Z = \text{dark greenish brown} \end{array} \right.$	$\left\{ \begin{array}{l} \text{colorless} \\ \text{pale yellow} \\ \text{reddish brown} \end{array} \right.$	$\left\{ \begin{array}{l} \text{pale yellow} \\ \text{reddish yellow} \\ \text{reddish brown} \end{array} \right.$
Extinction on {010}	23°	47°	

In addition to the three species here mentioned, two other minerals, castanite² and paposite,² have been considered authentic species belonging to this group.

Castanite as originally described was given the composition $\text{Fe}_2(\text{SO}_4)_2(\text{OH})_2 \cdot 3\text{H}_2\text{O} \cdot 4\text{H}_2\text{O}$, which corresponds to the hohmannite composition. Later³ it was considered to be identical with amarantite, and recently⁴ it has been proposed that this mineral is a valid species. However, a proposal that castanite is neither valid nor the same as amarantite has most recently been made⁵ on the basis of its physical similarity to hohmannite. With the last opinion the writer is in agreement, having arrived at this conclusion independently.

Paposite was originally given a composition corresponding to the formula $\text{Fe}_4(\text{SO}_4)_3(\text{OH})_6 \cdot 7\text{H}_2\text{O}$. However, the material from the type locality, preserved in a glass case at the University of Chile, appears to be, by inspection, amarantite. All of the so-called paposite in the collection of the National Museum at Santiago, Chile, is likewise amarantite. The original analysis, with 30 per cent of impurities, cannot be considered as adequate proof of the validity of this mineral.

Hohmannite

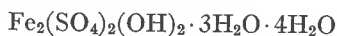

Crystallography: Triclinic. No crystals of this mineral were available for study.

Optical properties: Color, light amaranth-red to chestnut-brown. Transparent to translucent.

	$n(\text{Na})$	
X=very pale yellow	$\alpha=1.559$	negative
Y=pale greenish yellow	$\beta=1.643$	$2V=40^\circ$
Z=dark greenish brown	$\gamma=1.655$	$r > v$ extreme

With only cleavages for orientation the optical orientation could not be worked out with any degree of certainty. The {010} cleavage yields a slightly off-center optical axis figure. Hohmannite can be distinguished from amarantite by the extinction on {010}. In hohmannite $Y \wedge [001] = 23^\circ$; in amarantite $Y \wedge [001] = 47^\circ$.

Chemistry: The composition of this mineral is not well established. The formula most suited to the analyses⁶ is that given above. The so-called castanite is in good agreement with the formula.

Hohmannite is always intimately associated with chalcantite and picromerite. The chalcantite is an earlier mineral and is believed to be formed from an earlier iron-chalcantite (pisanite?). It is usually in small, brilliant crystals showing a number of faces. Hohmannite is later than both fibroferrite and copiapite and earlier than amarantite. As stated before, it is an extremely unstable mineral, especially in a dry atmosphere, and readily dehydrates to the four hydrate mineral (meta-hohmannite).

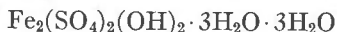
Amarantite

Small crystals of excellent quality were available for the crystallographic and optical study. The triclinic character of the mineral was confirmed. Two new forms were established, using the elements of Penfield.

Crystallography: Triclinic

$$a:b:c=0.7692:1:0.5738; \alpha=95^\circ 38\frac{1}{2}', \beta=90^\circ 23\frac{1}{2}'; \gamma=97^\circ 13'$$

$$p_0:q_0:r_0=0.7484:0.5784:1; \lambda=84^\circ 17', \mu=88^\circ 53'; \nu=82^\circ 42\frac{1}{2}'$$

$$p_0'=0.7522, q_0'=0.5813; x_0'=0.0069, y_0'=0.1004.$$

New Forms:

	Measured		Calculated	
	ϕ	ρ	ϕ	ρ
320	58°56'	90°00'	57°05'	90°00'
301	77 30	66 17	80 11½	66 14½

These two forms are weak and not in good position so that they must be regarded as uncertain.

Optical properties: Color, amaranth-red. Transparent.

	ϕ	ρ	$n(\text{Na})$	
α =colorless	82°	72°	1.516	Negative
β =pale yellow	178°	68°	1.598	2V=30°
γ =reddish brown	-44°	29°	1.621	$r < v$, horizontal

Chemistry: Amarantite has the composition $\text{Fe}_2(\text{SO}_4)_2(\text{OH})_2 \cdot 3\text{H}_2\text{O} \cdot 3\text{H}_2\text{O}$. This composition is well established, although a recent analysis indicated somewhat less water. This was perhaps due to some dehydration of the material which had been collected some fifty years before the analysis was made.

Occurrence: Found in the oxidized portions of massive quartz-pyrite veins at Chuquicamata and Quetena. Always found associated with hohmannite and usually with fibroferrite. Amarantite occurs along the walls of small sulphate veins with the centers usually occupied by hohmannite and fibroferrite or in crystalline masses within the hohmannite. It commonly forms in chalcantite or pisanite and develops the characteristic acicular crystals in either medium. It is less commonly associated with fibroferrite than is hohmannite. It is clearly later than all these minerals in period of formation. The only data on its sequence relationships are derived from the statement by R. Scharizer⁷ that it is later in formation than copiapite. Scharizer worked with the system $\text{Fe}_2\text{O}_3\text{-SO}_3\text{-H}_2\text{O}$ and found that when the ratio $\text{SO}_3/\text{Fe}_2\text{O}_3$ was less than 2.5 a mixture of copiapite and amarantite formed but with a ratio equal to 2.5 only copiapite formed. Posnjak and Merwin⁸ working with the

same system between the temperatures 200°C. to 50°C. did not obtain any amaranthite, and at 50° found that copiapite formed with concentrations between 2.74 and 3.66, and below 2.69 no copiapite was formed. There is some question regarding the state of equilibrium of Scharizer's solutions. Posnjak and Merwin failed to find amaranthite, fibroferrite and hohmannite. On the basis of these data can we assume that these three minerals form from solutions not in equilibrium?

Metahohmannite



This mineral is the dehydration product of hohmannite and has been found only as an orange powdery material in association with that mineral. Analyses have been made⁹ on this dehydrated substance, but it has been heretofore unnamed.

The optical properties were first measured in the course of this study. They are:

$$\begin{aligned} \alpha &= 1.709 = \text{pale yellow} \\ \beta &= 1.718 = \text{reddish yellow} \\ \gamma &= 1.734 = \text{reddish brown} \end{aligned}$$

The loss of about half the water (molecularly) has increased the refractive indices greatly over those of hohmannite.

REFERENCES. ¹ Scharizer, *Zeits. Krist.*, vol. **65**, p. 335, 1927.

² Darapsky, *N. Jb. Min.*, **1**, p. 49, 1890.

³ Linck, in Hintze, vol. **1**, p. 4426, 1929.

⁴ Rogers *Am. Mineral.*, vol. **16**, p. 396, 1931. The material called castanite by Bandy *Am. Mineral.*, vol. **17**, p. 534, 1932, has since been re-examined and proved to be amaranthite.

⁵ Ungemach, *Bull. Soc. Min.*, vol. **58**, p. 97, 1935.

⁶ Analysis on original material by Frenzel, *Minn. Mitt.*, vol. **9**, pp. 398 and 423, 1887; also Frenzel, *Min. Mitt.*, vol. **11**, p. 215, 1890; Ungemach, 1935. Analyses on "castanite" by Darapsky, 1890, and Ungemach, 1935.

⁷ Scharizer, in Doelter, **4**, 2, 574, 1929.

⁸ Posnjak and Merwin, *Jour. Am. Chem. Soc.*, vol. **44**, p. 1965, 1922.

⁹ Mackintosh, 1889, and Ungemach, 1935.

Fibroferrite

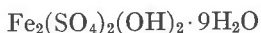

Fibroferrite was identified from physical and optical properties and from older analyses made at Chuquicamata. The color ranged from grayish white in efflorescent crusts to a silky greenish gray on fresh

fractures of the massive mineral. The following optical properties were determined on fresh material:

	<i>n</i>
α —colorless	1.513
β —colorless	1.535
γ —pale brownish yellow	1.571

After a short exposure to air the mineral dehydrates into a soft incoherent mass of radiating fibers.

At Chuquicamata it is commonly associated with hohmannite and amarantite, being earlier than either of these minerals. In one of the more massive occurrences, chalcantite is a common associate but age relationships could not be determined. At Quetena it occurs as a late efflorescence on the walls of workings and in cracks in some of the massive minerals.

Voltaite

Voltaite was determined on the basis of optical properties. The Alcaparrosa voltaite is leek-green in crushed fragments. It is isotropic with an index of 1.608. Slight anisotropism was observed.

This is not an abundant mineral at Chuquicamata, being confined to the areas of massive pyrite veins and commonly associated with coquimbite. From field relations it appears to be earlier than metavoltine although the minerals have not been observed intimately associated. It is later than coquimbite. At Quetena it occurs massive in massive coquimbite in the bottom of the pit. Its paragenetic relationships were not clear. Voltaite occurs in small crystals at Alcaparrosa imbedded in pickeringite and alums.

Botryogen

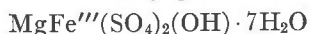

A number of minerals have been described and given species names that have later been proved to belong to this species. There are two reasons for this. The original and early descriptions of botryogen were inaccurate and the descriptions and identifications of synonymous species were either inaccurate or, in the case of palacheite, more accurate than the original description of botryogen proper.

During this study the writer has concluded that quetenite, rubrite, idrizite, palacheite and the mineral called kubeite should all be included under botryogen as synonyms. All of these minerals have been recognized as thus related by one writer or another. Positive identification can be made on quetenite.

Crystallography:¹Monoclinic; prismatic— $2/m$

$$a:b:c=0.5893:1:0.3996 \quad \beta=100^{\circ}01'$$

$$p_0:q_0:r_0=0.6781:0.3935:1 \quad \mu=79^{\circ}59'$$

$$r_2:p_2:q_2=1.4747:1.7232:1$$

$$p_0'=0.6886, q_0'=0.3996; x_0'=0.1766$$

Forms	ϕ	ρ	ϕ_2	$\rho_2=B$	C	A
<i>b</i> 010	0°00'	90°00'	—	0°00'	90°00'	90°00'
<i>a</i> 100	90 00	90 00	0°00'	90 00	79 59	0 00
<i>e</i> 270	26 13	90 00	0 00	26 13	85 35½	63 47
<i>k</i> 130	29 52½	90 00	0 00	29 52½	85 02	60 07½
<i>f</i> 250	34 34½	90 00	0 00	34 34½	84 20	55 25½
<i>l</i> 120	40 45	90 00	0 00	40 45	83 29	49 15
<i>h</i> 350	45 57½	90 00	0 00	45 57½	82 49	44 02½
<i>t</i> 450	54 02½	90 00	0 00	54 02½	81 54½	35 57½
<i>m</i> 110	59 52½	90 00	0 00	59 52½	81 21	30 07½
<i>i</i> 210	73 49	90 00	0 00	73 49	80 23	16 11
<i>F</i> 310	79 03	90 00	0 00	79 03	80 10	10 57
<i>p</i> 011	23 50½	23 36	79 59	68 31	21 29	80 41
<i>s</i> 021	12 27½	39 18	79 59	51 48	38 12	82 08½
<i>P</i> 031	8 23	50 28	79 59	40 16	49 44	83 33
<i>d</i> 101	90 00	40 54	49 06	90 00	30 53	49 06
<i>o</i> $\bar{1}$ 01	-90 00	27 04	117 04	90 00	37 05	117 04
<i>r</i> 111	65 14	43 39	49 06	73 11½	34 45½	51 11½
<i>z</i> 221	67 17½	64 13	27 38	69 39½	55 03½	33 50
<i>n</i> $\bar{1}$ 11	-51 58½	32 58½	117 04	70 25	41 16½	115 23
<i>D</i> 121	47 18	49 41	49 06	58 52	42 43½	55 55
<i>u</i> 131	35 51	55 56	49 06	47 49	50 30½	60 58½
<i>w</i> 141	28 27	61 11	49 06	39 37	56 49½	65 19½
<i>v</i> $\bar{1}$ 21	-32 35½	43 29½	117 04	54 33½	49 27½	111 45½
<i>q</i> $\bar{1}$ 31	-23 05	52 30	117 04	43 08	56 57	108 07½
<i>x</i> $\bar{1}$ 71	-10 21	70 37½	117 04	21 52½	72 42½	99 45½
<i>y</i> $\bar{2}$ 11	-75 35	58 04½	147 15	77 48	67 48½	145 17½

Crystals of botryogen were first described by Haidinger¹⁵ and have been frequently studied by later workers. All the early work suffered from the poor quality of the crystals available. Eakle¹³ obtained the first reliable results on the material which he named palacheite but which proved to be botryogen. In this study excellent crystals of quetenite have been measured both by the author and by Dr. Berman, and

they have finally established its identity with botryogen. The results of these studies are contained in the table of forms observed by each, together with a column showing symbols of each known form in the new position.

Eakle	BOTROYOGEN: OBSERVED FORMS.			Palache New Symbol
	Berman	Bandy		
<i>c</i> 001	<i>c</i>	<i>c</i>		<i>o</i> 101
<i>b</i> 010	<i>b</i>	<i>b</i>		<i>b</i> 010
<i>a</i> 100	—	—		<i>a</i> 100
—	—	<i>e</i> 270		<i>e</i> 270
—	<i>k</i> 130	<i>k</i>		<i>k</i> 130
—	—	<i>f</i> 250		<i>f</i> 250
<i>l</i> 120	<i>l</i>	<i>l</i>		<i>l</i> 120
—	—	<i>h</i> 350		<i>h</i> 350
<i>t</i> 450	—	—		<i>t</i> 450
<i>m</i> 110	<i>m</i>	<i>m</i>		<i>m</i> 110
—	—	<i>i</i> 210		<i>i</i> 210
—	—	<i>F</i> 310		<i>F</i> 310
<i>n</i> 011	<i>n</i>	<i>n</i>		<i>n</i> 111
<i>o</i> 021	<i>o</i>	<i>o</i>		<i>v</i> 121
—	—	<i>q</i> 031		<i>q</i> 131
—	—	<i>x</i> 071		<i>x</i> 171
<i>d</i> 201	<i>d</i>	<i>d</i>		<i>d</i> 101
<i>p</i> 111	<i>p</i>	<i>p</i>		<i>p</i> 011
<i>s</i> 121	<i>s</i>	<i>s</i>		<i>s</i> 021
—	—	<i>P</i> 131		<i>P</i> 031
—	<i>r</i> 211	<i>r</i>		<i>r</i> 111
—	—	<i>D</i> 221		<i>D</i> 121
—	<i>u</i> 231	<i>u</i>		<i>u</i> 131
—	<i>w</i> 241	<i>w</i>		<i>w</i> 141
—	<i>z</i> 321	<i>z</i>		<i>z</i> 221

Habit: Prismatic [001]; smaller crystals long prismatic, large crystals short prismatic; common forms *o b m l n*; vertical zone striated [001]. In the larger short crystals *o* is the dominant form, often striated [100].

Twinning: Not observed.

Cleavage: {010} perfect; {110} good.

Physical Properties: Fracture conchoidal and interrupted, brittle.

G 2.10, H 2.0—2.5. Luster vitreous.

Optical Properties: Color light to dark orange-red. Transparent to translucent.

$\alpha = 1.523$	$X = b$	colorless to pale brown	Biaxial positive
$\beta = 1.530$		cinnamon brown	$2V = 42^\circ$
$\gamma = 1.582$	$Z \wedge c = +12^\circ$	golden yellow	$r > v$ strong

Composition: $\text{MgFe}''(\text{SO}_4)_2(\text{OH}) \cdot 7\text{H}_2\text{O}$

ANALYSIS BY HENDERSON*		THEORETICAL COMPOSITION
(Quetenite)		
Fe_2O_3	19.73	19.28
MgO	9.40	9.64
SO_3	38.45	38.55
H_2O	32.00	32.53
Total	100.18	100.00

* U. S. National Museum. Unpublished.

Difficultly soluble in water with precipitation of iron hydroxide. Soluble in dilute acids.

Pyrognostics: B.B. brown to black. Exfoliates in flame. Closed tube, yields copious water.

Occurrence: Botryogen is common at Chuquicamata intimately associated with hohmannite and amarantite. At Alcaparrosa it occurs near the surface associated with copiapite in smaller veins. Botryogen is not associated with the more massive and purer occurrences of iron sulphates.

Botryogen (quetenite) occurs at Quetena in large masses, characteristically in halos of coarse radiating crystals about a center of copiapite. The crystals radiate outwardly from the copiapite core. Often these nodules of copiapite-botryogen show rough cracks about the peripheries, which often contain fibres of pickeringite. Massive veins of pickeringite cut the botryogen in many cases.

The sequence relationship that can be definitely established is,

Pickeringite	$\text{MgAl}_2(\text{SO}_4)_4 \cdot 22\text{H}_2\text{O}$
Botryogen	$\text{Mg}_2\text{Fe}_2(\text{SO}_4)_4(\text{OH})_2 \cdot 14\text{H}_2\text{O}$
Parabutlerite	$\text{Fe}(\text{SO}_4)(\text{OH}) \cdot 2\text{H}_2\text{O}$
Amarantite	$\text{Fe}(\text{SO}_4)(\text{OH}) \cdot 3\text{H}_2\text{O}$
Hohmannite	$\text{Fe}_2(\text{SO}_4)_2(\text{OH})_2 \cdot 7\text{H}_2\text{O}$
Copiapite	$\text{Fe}_4(\text{SO}_4)_6(\text{OH})_2 \cdot 16\text{H}_2\text{O}$

From these data it is apparent that the introduction of magnesia causes a departure from the sequence of the pure iron sulphates. The botryogen, while basic, is less basic than the parabutlerite and the pickeringite, the last formed, is a normal sulphate.

The relations of the various substances, all believed to be identical with botryogen, is brought out in the following table of analyses.

Rubrite answers the description of quetenite and, since it was identified from the analysis of an impure material, there can be little question but that it belongs here.

The original analysis of quetenite from Quetena (Salvador Mine)⁵ was made on impure material, evidently a mixture of quetenite and some iron sulphate. Rubrite was described from the Rio Loa by Darapsky² and earlier kubeite from the same locality and by the same writer.³ These are both impure mixtures of botryogen and other sulphates. Analyses of these minerals as well as other analyses of this species are quoted here for comparison. Quetenite was first recognized as a synonym of botryogen by Larsen and Berman⁴ on the basis of similar optical properties. In the course of this investigation an analysis of typical quetenite was made and it was found to be identical with botryogen. Their crystallographic identity was also established.

ANALYSES OF BOTRYOGEN							
	1	2	3	4	5	6	7
MgO	6.65	7.40	7.31	10.21	5.69	6.18	3.59
Fe ₂ O ₃	18.73	16.69	19.60	20.63	26.50	26.64	20.50
SO ₃	37.64	37.00	37.78	38.10	36.53	32.42	40.95
H ₂ O	31.04	34.10	31.39	29.47	30.90	31.04	30.82
FeO	0.53	2.24	0.38				4.12
CaO		1.06			2.91		
MnO		1.93	0.44				
ZnO	4.82		2.50				
Al ₂ O ₃						2.73	
P ₂ O ₅						0.11	
Insol.	0.27	0.30	0.21				
Total	99.68	100.72	99.61	98.41	102.53	99.12	99.98
	8	9	10	11	12	13	14
MgO	5.92	9.40	9.35	5.62	7.8	4.51	9.95
Fe ₂ O ₃	22.70	19.73	19.51	18.22	19.3	8.70	19.81
SO ₃	37.37	38.45	38.37	41.15	36.4	33.94	39.48
H ₂ O	34.01	32.00	32.28	27.64	33.7	40.80	30.76
CaO				4.10	0.1		
Fe(Mn)O						3.10	
Al ₂ O ₃				3.01	abs.	8.59	
Insol.					2.7		
Total	100.00	100.18	99.51	99.84	100.0	99.64	100.00

1-4. Botryogen, 1. Cleve,⁶ 2. Hockauf, analyst.⁷ 3. Mauzelius, anal.⁸ 4. Ungemach, anal.⁹

5-7. Botryogen? 5. Berzelius, anal.¹⁰ 6. Ungemach, anal.¹¹ 7. Blaas, anal.¹²

8. Quetenite. Frenzel, anal.⁵ 9. Quetenite. Henderson, U. S. Nat. Museum, unpublished anal.

10. Palacheite. Eakle, anal.¹³
11. Rubrite. Darapsky, anal.²
12. Kubeite. Darapsky, anal.³
13. Idrizite. Schrauf, anal.¹⁴
14. Quetenite. Anal. of the Chile Exploration Co., Chemical Laboratory. Through the courtesy of O. W. Jarrell.

REFERENCES. ¹ The elements and angles of this table are derived from the observations of Berman¹⁶ on quetenite. They were very close to Eakle's¹³ observations on botryogen (palacheite). Eakle's elements give an unsymmetrical distribution of the forms and have been modified by Palache according to the transformation Eakle→Palache $\bar{1}0\bar{1}/0\bar{1}0/001$.

² Darapsky, *N. Jb. Min.*, vol. 1, p. 65, 1890.

³ Darapsky, *N. Jb. Min.*, vol. 1, p. 163, 1898.

⁴ Larsen and Berman, *Bull.* **848**, U.S.G.S., 1934.

⁵ Frenzel, *Min. Mitt.*, vol. 11, p. 217, 1890.

⁶ Cleve, *Upsala Un. Arsskrift*, vol. 22, 1862.

⁷ Hockauf, *Zeits. Krist.*, vol. 12, p. 251, 1886.

⁸ Mauzelius, *Geol. För. Förh.*, vol. 17, p. 311, 1895.

⁹ Ungemach, *Bull. Soc. Fr. Min.*, vol. 57, p. 97, 1935.

¹⁰ Berzelius, *Afh. i. Fys.*, vol. 4, p. 307, 1815.

¹¹ Ungemach, *Bull. Soc. Fr. Min.*, vol. 29, p. 271, 1906.

¹² Blaas, *Sitzber. Wiener Ak., 1 Abt.*, vol. 8, pp. 87, 161, 1883.

¹³ Eakle, *Bull. Univ. Calif.*, vol. 3, p. 231, 1903.

¹⁴ Schrauf, *Jb. d. geol. R. A. Wien*, vol. 41, p. 379, 1891.

¹⁵ Haidinger, *Pogg.*, vol. 12, p. 491, 1828.

¹⁶ Berman, Unpublished data on botryogen (quetenite).

Alunite

Alunite occurs at Chuquicamata as a supergene vein mineral and in the oxidized gossans of the larger pyrite veins. It commonly shows the characteristic "hopper structure." In veins associated with antlerite it is the earlier mineral. In the oxidized gossans it was only observed altered to jarosite. The writer was never able to separate the mineral in order to determine whether it was the potassium or sodium variety of alunite.

JAROSITE GROUP

Jarosite and natrojarosite are relatively common minerals in all of these deposits. They are late minerals as a rule and serve well as key minerals for the later part of the mineral sequence.

Jarosite

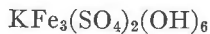

Jarosite is common at Chuquicamata in fibrous and massive aggregates and in minute tabular crystals. It occurs throughout the deposit but is most common in massive form in the central part. A micaceous variety with the external appearance of argento-jarosite was known as

apatelite¹ locally. The jarosite at Chuquicamata carries a small but variable percentage of silver as a rule and argento-jarosite may be a rare mineral of the deposit. All of the jarosite examined in this study was either the potassium or sodium variety. A rare form of jarosite is a variety pseudomorphic after either alunite or natroalunite. The jarosite has replaced the alunite, preserving the "hopper crystal" structure of the original mineral. The jarosite shows an average index, $n = 1.816$.

Jarosite occurs in minute crystals and crystalline and granular crystals at Quetena and Alcaparrosa. The mineral has an index $n = 1.818$ at both places. The jarosite at Alcaparrosa commonly shows under the microscope a slight divergence of the optic axes.

Jarosite commonly forms at the end of the iron sulphate period and before the copper sulphate period. Reversals of this order were recorded during the study, but the sequence relationships were not always definite.

REFERENCE. ¹ Meillet, *Ann. des Mines*, vol. 3, p. 808, 1841.

Natrojarosite



The tiny brilliant cinnamon brown crystals of natrojarosite at Chuquicamata afforded an opportunity to study the crystallography, and especially the twinning of this species. An explanation of the previously noted anomalous optical behavior is given, and other new data are here presented.

Crystallography:

Orthorhombic (Pseudorhombic)

$a:b:c = 1.732:1:2.252$		$p_0:q_0:r_0 = 1.300:2.252:1$				
$q_1:r_1:p_1 = 1.732:0.769:1$		$r_2:p_2:q_2 = 0.444:0.577:1$				
Forms	ϕ	$\rho = C$	ϕ_1	$\rho_1 = A$	ϕ_2	$\rho_2 = B$
<i>c</i> 001	—	0°00'	0°00'	90°00'	90°00'	90°00'
<i>m</i> 110*	60°00'	90 00	90 00	60 00	0 00	30 00
<i>u</i> 101	90 00	52 26	0 00	37 34	37 34	90 00

* Noted only as a twin plane.

Form	Measured No. of Faces	Range
<i>u</i> 101	29	ρ 52°06'–52°57'

Habit: Commonly in cuboid trillings; common forms: *c*, *u*.

Twins: In trillings; twin plane (110).

Physical properties: Fracture conchoidal, brittle; $H=3$. Luster vitreous.

Optical properties: Color, cinnamon brown. Basal section divided into three biaxial segments. Biaxial negative, $2V$ small; $\beta=1.826$. $X=c$; $Y=a$.

The first observation that natrojarosite was not uniaxial, and that it was made up of biaxial segments, was on material from Schlaggenwald.¹ Later² the same optical effects were noted on specimens from Buxton Mine, North Dakota. The same effect, but less distinct, has been noted on other members of the jarosite group.³

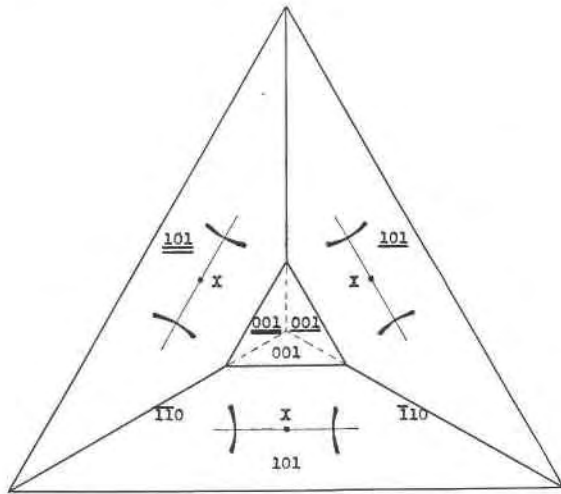

FIG. 7. Sketch showing optical orientation in the orthorhombic trillings of natrojarosite.

The optical orientation on the various segments is illustrated in Fig. 7, where X emerges sensibly normal to each of the (001) faces, the latter being co-planes in the twin. The plane of the optic axes is parallel, in each case, to (100) . Under these circumstances, the smaller $2V$ is, the more difficult it becomes to recognize the segmentation of the twins, for, if $2V=0$, no birefringence would be noted and the twinning could not be detected under the microscope. The potassium members of the group have presumably a smaller $2V$ because the effect is less marked than in natrojarosite, and the Chuquicamata natrojarosite exhibits the twinning best because it is the most sodic of any yet found.⁴

Chemistry: A basic sodium ferric sulphate, $\text{NaFe}_3(\text{SO}_4)_2(\text{OH})_6$, with small amounts of potassium sometimes substituting for the sodium.

ANALYSIS BY F. A. GONVER

	Per Cent	Molecular Ratios	
Na ₂ O	5.51	.091	1 × .091
K ₂ O	0.15		
Fe ₂ O ₃	48.08	.302	3 × .101
SO ₃	34.65	.433	4 × .108
H ₂ O	11.83	.659	6 × .110
Total	100.22		

Occurrence: The mineral was first described,⁵ but not named, from the Buxton Mine, Lawrence County, North Dakota. Later⁶ it was found at Soda Springs Valley, Nevada, and at Cook's Peak, New Mexico, and was given the name natrojarosite.

At Chuquicamata natrojarosite is associated with chalcantite, kroehnkite and sulphur. It is a late mineral, forming after most of the iron sulphates and before most of the copper sulphates.

REFERENCES. ¹ Slavik, *Zeits. Krist.*, vol. 39, p. 297, 1904, stated that the natrojarosite showed six segments in the basal section, and that the axial plane is (010). These data are not in agreement with the writer's.

² Cesaro, *Bull. Ak. Roy. Belge*, 138, 1905.

³ Larsen and Berman, *Bull.*, 848, *U. S. Geol. Survey*, 1934.

⁴ For other analyses see Hillebrand and Penfield *Am. J. Sc.*, vol. 14, p. 211, 1902; also Dana, *System*, Ap. III.

⁵ Headden, *Am. J. Sc.*, vol. 46, p. 24, 1893.

⁶ Hillebrand and Penfield, *Am. J. Sc.*, vol. 14, p. 211, 1902.

Ungemachite

This mineral, discovered in the course of this investigation, has been described in detail by Peacock and Bandy in a recent paper.¹ The following abstract of properties is taken from that paper.

Crystallography: Hexagonal, rhombohedral— $\bar{3}$. $a:c = 1:2.2966$, $\alpha = 62^\circ 51\frac{1}{2}'$; $p_0:r_0 = 2.6519:1$, $\gamma = 108^\circ 15\frac{1}{2}'$.

Forms: Numerous, the habit dominantly rhombohedral with $r(10\bar{1}1)$, $M(01\bar{1}2)$, $p(11\bar{2}3)$, and the base $c(0001)$.

Structure cell: Rhombohedral: $a_0 = 10.84 \pm 0.02 \text{ \AA}$, $c_0 = 24.82 \pm 0.03 \text{ \AA}$. $a_0:c_0 = 1:2.290$. Contains $\text{Na}_3\text{K}_3\text{Fe}(\text{SO}_4)_6 \cdot 10\text{H}_2\text{O}$.

Cleavage: Perfect, basal.

Physical properties: $H = 2\frac{1}{2}$. $G = 2.287 \pm .003$ (Berman).

Optical properties: Colorless, transparent. Uniaxial negative. $\omega = 1.502$, $\epsilon = 1.449$.

Chemical composition:

ANALYSIS BY F. A. GONYER	
Na ₂ O	21.61
K ₂ O	11.35
Fe ₂ O ₃	7.69
SO ₃	40.23
H ₂ O	16.69
N ₂ O ₅	tr.
Insol.	2.07
	<hr/>
Total	99.64

Composition as written above is not homologous with any known natural or artificial salt.

Occurrence: Ungemachite occurs in granular vein fillings and lining small vugs in massive jarosite and metasideronatrite. The mineral is very scarce in the material collected. The name is in honor of the late Henri Ungemach, mineralogist of Strasbourg.

REFERENCE. ¹ Peacock and Bandy, *Am. Mineral.*, vol. 23, p. 314, 1938.

Clino-Ungemachite

Clino-ungemachite¹ is a monoclinic mineral closely similar in appearance and occurrence to ungemachite from which it was distinguished only by goniometric measurements. The divergence of angles from rhombohedral symmetry is slight, and it is presumed that the composition of this substance is close to that of ungemachite. But as only six minute crystals were found its nature is still uncertain.

REFERENCE. ¹ Peacock and Bandy, *Am. Mineral.*, vol. 23, p. 314, 1938.

MOLYBDATE

Lindgrenite



Lindgrenite¹ is monoclinic, holohedral. $a:b:c=0.5941:1:0.5124$; $\beta=92^\circ 12'$. The crystals are green and transparent, tabular parallel to (010), which is a perfect cleavage. Unit cell: $a_0=8.45$, $b_0=14.03$, $c_0=7.04$; $\beta=92\frac{1}{2}^\circ$; containing $\text{Cu}_{12}(\text{MoO}_4)_8(\text{OH})_8$. $H=4\frac{1}{2}$. $G=4.26$. Biaxial negative; $Z=b$; $X:c=+7^\circ$. $\alpha=1.930$, $\beta=2.002$, $\gamma=2.020$; $2V=71^\circ$; $r>v$. Analysis: CuO 40.62, MoO₃ 50.97, H₂O 3.30, Fe₂O₃ 1.43, Insol. 3.34; Sum 99.66; giving the above formula. Soluble in HCl and in HNO₃.

This unusual mineral, the first known molybdate of copper was collected by the writer during his residence at Chuquicamata. It occurs associated with antlerite and iron oxide in massive quartz veins on the western side of the deposit. The mineral is rather common, although fine

crystallized specimens are rare. It occurs along the edges of the larger quartz veins. In this connection it is possibly significant that the molybdenum in the smaller "lacing veinlets" of quartz occurs along or near the edges of the veins. Antlerite follows the lindgrenite and replaces it.

REFERENCE. ¹ Palache, *Am. Mineral.*, vol. 20, p 484. 1935.

INDEX OF MINERAL SPECIES

	Page		Page
Alunite.....	754	Halite.....	704
Amarantite.....	747	Halotrichite.....	728
Anhydrite.....	712	Hematite.....	708
Antlerite.....	713	Hohmannite.....	746
Antofagastite.....	705		
Arsenopyrite.....	703	Jarosite.....	754
Atacamite.....	706		
Azurite.....	710	Kalinite.....	721
		Kroehnkite.....	730
Bandykite.....	704		
Bloedite.....	719	Lapparentite.....	740
Bornite.....	702	Leightonite.....	719
Botryogen.....	749	Limonite.....	709
Brochantite.....	713	Lindgrenite.....	758
Cerussite.....	709	Magnetite.....	708
Chalcanthite.....	718	Malachite.....	709
Chalcocite.....	701	Melanterite.....	717
Chalcopyrite.....	702	Mendozite.....	722
Chenevixite.....	711	Metahohmannite.....	748
Chrysocolla.....	710	Metasideronatrite.....	733
Climo-ungemachite.....	758	Metavoltine.....	735
Copiapite.....	737	Mirabilite.....	714
Copper.....	699	Molybdenite.....	700
Copper Pitch.....	708		
Coquimbite.....	729	Natrochalcite.....	731
Covellite.....	701	Natrojarosite.....	755
Cuprite.....	707		
Cuprocopiapite.....	737	Opal.....	707
Dolomite.....	709	Parabutlerite.....	742
		Paracoquimbite.....	729
Energite.....	703	Pickeringite.....	724
Epsomite.....	717	Picromerite.....	719
		Pisanite.....	718
Ferrinatrite.....	731	Pyrite.....	702
Fibroferrite.....	748		
		Quenstedtite.....	739
Gold.....	700		
Gypsum.....	717		

Rhomboclase.....	740	Tetrahedrite.....	703
Roemerite.....	734	Thenardite.....	712
Soda Niter.....	712	Tourmaline.....	710
Sphalerite.....	701	Turquoise.....	711
Sphene.....	711	Ulexite.....	712
Sulphur.....	699	Ungemachite.....	757
Szomolnokite.....	714	Voltaite.....	749
Tamarugite.....	723		