

MEASUREMENTS OF THE INDICES OF REFRACTION IN ANISOTROPIC MEDIA*

T. T. QUIRKE AND W. C. LACY

CONTENTS

Abstract	705
Acknowledgments	705
Introduction	706
Measurement of ray directions	706
Equipment and procedure	706
Observations	711
Circular half-cylinder	711
Calculations of refraction of e ray	717
Elliptical half-cylinder	718
Bausch and Lomb optically true half-cylinder	721
Conclusions	724
References	724

ABSTRACT

Test pieces of calcite were prepared in order to measure directly the refraction of the ordinary and extraordinary rays in all crystallographic directions. Two half-cylinders were made from transparent calcite crystals; one being a semi-circle in cross section, and the other a half-ellipse. The dimensions of the ellipse were directly proportional to the values of the velocities of the extraordinary ray—parallel and normal to crystallographic c axis. The minor axis of the ellipse was made parallel to and the major axis normal to crystallographic c . The semi-circular specimen was cut with the crystallographic c parallel to the diameter. For both specimens observations were made on a goniometer with transmitted light. The ordinary ray emerged, refracted only at the surface of incidence of the semi-circular cylinder, but the extraordinary wave normal was also refracted when leaving the calcite-air surface. The extraordinary ray was observed to follow a course in air after deflection at the surface of the calcite half-cylinder which agrees with the course to be expected according to computations. With the elliptical half-cylinder the extraordinary ray appeared to emerge from the calcite with almost no deflection from the computed course of the wave normal, and the ordinary ray, of course, was deflected.

In order to check the accuracy of the values obtained, observations were made on an optically true circular half-cylinder of identical size made by Bausch and Lomb Optical Company. This half-cylinder produced results essentially identical with those of the hand-made specimen.

The test pieces were difficult to make, but the results demonstrate clearly the behavior of the ordinary and extraordinary wave fronts in anisotropic media.

ACKNOWLEDGMENTS

The writers wish to express their appreciation to the Geological Society of America for its aid in this experimental work, to the National Youth Administration, for providing funds for drafting and computations, to Dr. G. M. Almy for his advice on certain optical phenomena, and to Dr. C. A. Chapman for many helpful suggestions.

* Part of Project No. 403, The Geological Society of America.

INTRODUCTION

The purpose of the series of experiments carried on by the authors was to analyze quantitatively the path of the ordinary and the extraordinary rays of light through an anisotropic substance for all angles of incidence and refraction, and to measure the index of refraction corresponding to each of these directions. This problem was suggested by the general confusion concerning this subject in textbooks of Mineralogy, Crystallography, and even in textbooks of Physical Optics, as noted by Tunell and Morey (1932), and more recently by Wooster (pp. 128 and 131).

Calcite, because of its high birefringence ($N_o - N_e = 0.1719$) and general use as an anisotropic illustrative mineral, was used in these experiments as the anisotropic medium.

MEASUREMENT OF RAY DIRECTIONS

EQUIPMENT AND PROCEDURE

Two half-cylinders were shaped from calcite crystals for the experimentation (Fig. 1). One half-cylinder, having a semi-circular cross-section with a 0.90 cm. radius and an altitude of approximately 1 cm.,

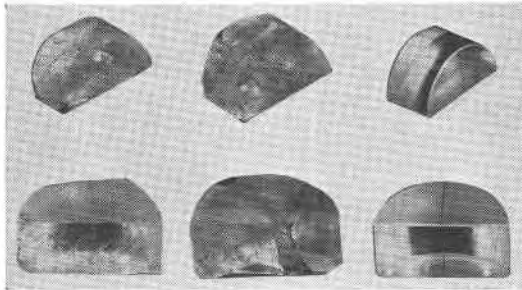

FIG. 1. Calcite test pieces cut in semi-circular and semi-elliptical forms with crystallographic c parallel to the diameter face. Two test pieces were hand-made and the third was made by the Bausch and Lomb Optical Company.

was cut so that prism face ($1\bar{1}00$) lay parallel to the diameter of the semi-circle. The other half-cylinder having a semi-elliptical cross-section was cut so that the prism face ($1\bar{1}00$) lay parallel to the minor axis of the ellipse. The ratio between the major and minor axes of the ellipse was directly proportional to the velocities of the extraordinary and ordinary rays, respectively (i.e., $2a = 20.00$ mm., $b = 11.155$ mm.). The half-cylinder was approximately 1 cm. in height. These half-cylinders were formed by grinding down calcite crystals on steel molds.

The semi-circular mold was formed by clamping together two blocks of steel, then drilling a hole of 1.8 cm. through them, using a point along the contact of the blocks as the center. By using two blocks the error which would result from the loss of thickness in sawing a single block in two was eliminated (Fig. 2). In the construction of the semi-elliptical mold an ellipse was drawn with its dimensions proportional to the ellipti-

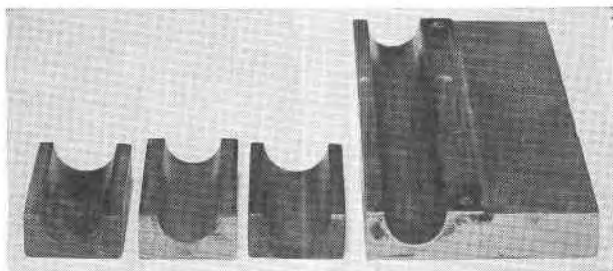

FIG. 2. Steel molds shaped for the grinding of the calcite test pieces.

cal ray surface originating from a point source of light in the anisotropic substance, calcite, as measured in a $(1\bar{1}00)$ section at the end of unit time (Fig. 2). This figure was drawn so that V_o/V_e or $0.67265/0.60304 = \text{major axis}/\text{minor axis} = 22.31\text{mm.}/20.00\text{ mm.}$, and was divided along the minor axis—the direction of crystallographic c . From this drawing a special cutting tool was shaped which would cut a groove identical with the drawing. With this tool a groove of the specified proportions was cut in a steel block.

A clear calcite crystal, free from flaws, was procured, and a section 1.8 cm. wide (measured along crystallographic c) and at least 1 cm. high, was cut from it. A prism face $(1\bar{1}00)$ was then selected for the flat face of the half-cylinder; it was smoothed down using a special abrasive¹ on a glass plate, and polished on a felt wheel using hematite rouge. This prism face was then cemented onto a glass microscope slide with De Khotinsky cement. The crystal segment was next ground down in the semicircular mold using 600 carborundum abrasive and keeping crystallographic c parallel to the diameter of the semi-circular cross-section. When the cylinder began to approximate the mold, the cylinder and the mold were thoroughly cleaned and the final grinding done with the finest abrasive. When the half-cylinder conformed exactly with the mold it was removed from the glass side and polished by hand, first on a felt wheel with

¹ Furnished by courtesy of the American Optical Company.

hematite rouge, then on a buffer wheel. Great care was taken not to heat the cylinder in polishing, since it was found that heating caused splitting along the cleavage planes. It was also found that if alcohol or xylol were used in cleaning the cylinder a portion of the liquid soaked into the calcite, causing splitting along cleavage planes. The semi-elliptical half-cylinder was formed in a similar manner to that just described for the circular one, except that the crystal section cut at right angles to crystallographic c was exactly 20.00 mm. wide, and in grinding crystallographic c was kept parallel to the minor axis of the ellipse.

The orientation of the crystallographic directions in the half-cylinders was checked by the use of a polarizing microscope using the usual gypsum plate, sensitive tint, test. The half-cylinders were in turn placed on a glass slide, placed beneath the microscope and observed between crossed nicols. Observations were first made with the half-cylinder in an erect position lying on the $(\bar{1}2\bar{1}0)$ crystal plane. The extinction positions indicated the crystallographic directions, and any angle between the extinction position and the diameter of the semi-circular cross-section was noted. The half-cylinders proved to be correctly oriented with respect to crystallographic c with a possible error of $\pm 30'$.

The next step was to arrange a shield for the prism face of the half-cylinder to regulate the point of entrance of the light ray. First, the exact median line of the prism face was located, using a pair of dividers, and marked at the top and bottom of the half-cylinder. Next, two strips of tinfoil or thin copper sheeting, 1 cm. \times 1 cm., were cut and cemented to the face with rubber cement so that at the exact median line there was a gap between the shields of not more than 0.025 cm. With larger openings, the images transmitted through the calcite were very poorly defined, and with smaller openings the range of possible readings was greatly reduced.

The measurements of the angles of refraction of the light ray for varied angles of incidence upon the prism face $(1\bar{1}00)$ of the calcite half-cylinders were read directly on a Fuess one-circle goniometer #2a. This is the same instrument described in the Fuess catalog.

The first experiments were carried on only with the hand-made test pieces. The two half-cylinders of calcite were each subjected to similar experimental procedure. The cylinder was mounted on the stage and secured in position with plastic clay. The stage was then centered so that the cylinder revolved on an imaginary vertical line bisecting the prism face of the half-cylinder, and the narrow slit between the two copper shields, occupying the median line of the prism face coincided exactly with the vertical cross-hair of the telescope (Fig. 3). The stage was then rocked by means of the two cylindrical sections arranged at right angles

to each other and having a common center, until the prism face of the half-cylinder was parallel to the vertical cross-hair, and the horizontal cross-hair struck the half-cylinder at the same height throughout a revolution of 360° . It was convenient to arrange the stage at such a height that the light image could be seen over the top of the cylinder. This was an aid in the rapid determination of the point of zero refraction. The stage was adjusted as to height by adjustment screw *k*.

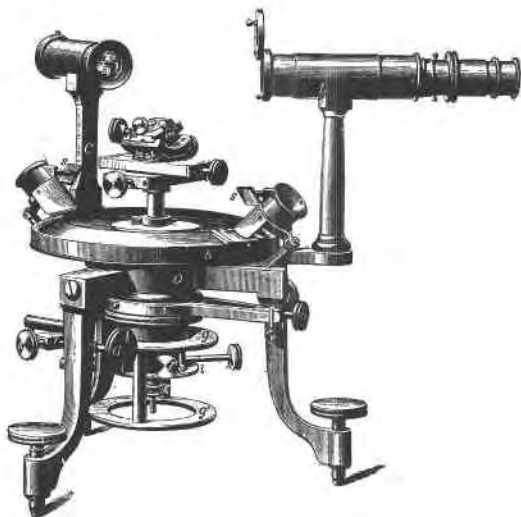

FIG. 3. A Fuess one-circle goniometer No. 2a. The various set-screws and parts are indicated by suitable letters for reference to the text.

A brilliant light source was placed behind the collimator tube *C*. In these experiments a white light source modified by a Websky slot placed in the rear of the collimator tube was used. The telescope, *L*, was focused on the light image by dropping the accessory lens from the system. The telescope was then swung around, lined up with the light image, and anchored by means of the gross motion screw α . The vernier was then turned until it read 0° , and anchored, using gross motion screw β . Fine adjustments were made with the tangential screw *G*.

The next step was to swing the stage, independent of the vernier, until the light from the collimator struck the prism face of the calcite half-cylinder with zero angle of incidence. This was accomplished by two methods. First, it was accomplished by the refraction method. The stage was slowly turned until the two images formed by the ordinary and extraordinary rays exactly coincided and fell on the vertical cross-

hair of the aligned telescope.² At this point the angle of incidence of the light impinging upon the prism face was zero. Set-screw l was then tightened, thus locking the stage to the vernier. The second method used was a reflection method, in which the exact orientation of the prism face was determined by a beam reflected from its surface. Set-screw l was loosened, so that the stage swung freely independent of the vernier. The gross motion screw β was loosened, and the vernier turned so that it read 45° when the telescope was lined up with the light source and again anchored in this position. Fine adjustments were made with the tangential screw G . Gross motion screw α was then loosened and the telescope swung around until the vernier read 135° , and then anchored. The stage was then revolved until the light source was swung into view and lined up with the vertical cross-hair. The stage was then anchored to the vernier scale by means of set-screw l ; the telescope was lined up with the light source and anchored; finally, the vernier and stage were turned until the vernier reading was 0° . At this point the angle of incidence of the light impinging upon the prism face of the half-cylinder was zero degrees. In these experiments both methods were used, one to check the other.

Following these preliminary adjustments the instrument was ready for making refraction readings on the calcite half-cylinder. Gross motion screw β was loosened and the stage swung around to the desired angle of incidence, anchored, and fine adjustments made with the tangent screw G . The angle of incidence was read directly from the vernier (Fig. 4). Gross motion screw α was then loosened and the telescope swung so that the two images of the ordinary and extraordinary rays were brought into view (Fig. 3). The identity of each of these rays was determined by means of a cap nicol placed over the eyepiece of the telescope. The vibration direction of the ordinary ray was vertical—perpendicular to crystallographic c and the vibration of the extraordinary ray was horizontal—in the plane of crystallographic c . The vertical cross-hair of the telescope was then centered on each of the light images—in cases of spectral dispersion the telescope was centered upon the yellow line—and the angle read directly from the vernier in each case (Fig. 4). The telescope was again lined up with the light source, anchored, and the stage revolved in the other direction in order to obtain an angle of incidence equal to that of the first but in the other quadrant of the half-cylinder.

² Some difficulty was encountered in this measurement in the circular half-cylinder due to a slight mal-alignment of the instrument. The image formed by the extraordinary image superimposed upon the ordinary image fell $37'$ to the right of the vertical cross-hair. This error was corrected in the calculations by averaging the readings in the two quadrants of the half-cylinder.

The procedure was the same as in the first readings except that all of the readings were subtracted from 360° to obtain the angles of incidence and the angles of refraction. In these experiments readings were taken in this manner at intervals of 2° incidence from 0° to 60° for the circular half-cylinder. A few readings were obtained between 60° and 80° , but the images were not distinct. Due to structural defects in the circular cylinder, it was not possible to get a complete set of readings for both

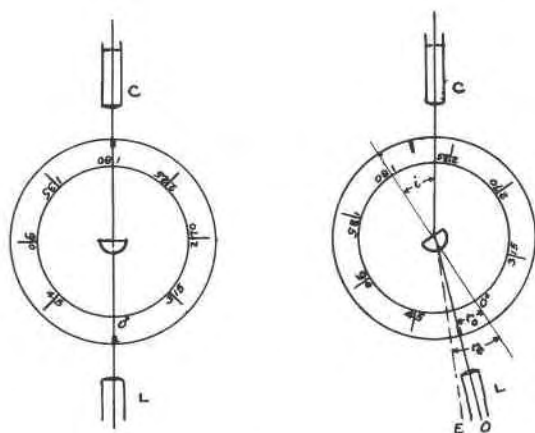

FIG. 4. Orientation of the instrument and test piece requisite for measurements of the angles of incidence and the refraction of the ordinary and extraordinary images.

quadrants. However, for all angles of incidence between 0° and 60° refraction readings were obtained in one or both quadrants. Readings for the elliptical half-cylinder were taken at intervals of 5° incidence from 0° to 80° . A complete set of readings was obtained in both quadrants for this range.

OBSERVATIONS

Circular half-cylinder.—The angular measurements from opposite quadrants obtained from the refracted rays emerging from the calcite circular half-cylinder were averaged together, thus correcting for a slight mal-alignment of the goniometer. In cases where only one reading was available, the net reading was corrected for the $0^\circ 37'$ instrumental mal-alignment.

The results obtained from the averaged angular measurements of the o ray correspond generally to the theoretical relation such that $\sin i / \sin r = 1.6583$ but with definite discrepancies. These discrepancies serve the very useful purpose of providing checks both as to the degree of accuracy

READINGS FROM CIRCULAR HALF-CYLINDER OF CALCITE
REFRACTION OF THE ORDINARY RAY

i	Right	Left	Average	Calculated	Difference between observation and theory
0°	-0°37'	+0°37'	0°00'	0°00'	
2°	—	—	—	—	
4°	—	—	—	—	
6°	—	5°00'	4°23'	—	
8°	—	6°18'	5°41'	—	
10°	6°35'	7°51'	7°13'	6°01'	+1°12'
12°	—	8°32'	—	—	
14°	8°35'	—	—	—	
16°	9°40'	—	—	—	
18°	10°44'	—	—	—	
20°	12°04'	12°24'	12°09'	11°54'	+0°15'
22°	—	13°30'	—	—	
24°	—	14°37'	—	—	
26°	—	15°46'	—	—	
28°	—	16°58'	—	—	
30°	17°18'	17°51'	17°35'	17°33'	+0°02'
32°	—	18°58'	18°33'	—	
34°	19°09'	19°44'	19°26'	—	
36°	19°57'	20°59'	20°28'	—	
38°	21°05'	22°00'	21°32'	—	
40°	22°04'	22°47'	22°36'	22°49'	-0°23'
42°	22°57'	23°36'	23°16'	—	
44°	23°43'	24°29'	24°03'	—	
46°	24°31'	25°26'	24°58'	—	
48°	25°44'	26°12'	25°58'	—	
50°	26°22'	27°05'	26°43'	27°31'	-0°48'
52°	27°18'	27°56'	27°37'	—	
54°	28°02'	28°47'	28°25'	—	
56°	29°00'	29°30'	29°15'	—	
58°	29°31'	30°12'	29°52'	—	
60°	30°19'	30°55'	30°37'	31°29'	-0°51'
70°	—	31°30'	31°10'	34°31'	-3°21'
75°	—	32°48'	32°28'	35°38'	-3°10'
80°	—	34°00'	33°40'	36°56'	-3°16'

REFRACTION OF THE EXTRAORDINARY RAY³
($I+r_{e_1}$)

i	Right	Left	Average	Calculated	Difference between observation and theory
0°	-0°37'	+0°37'	0°00'	0°00'	
2°	—	—	—	—	
4°	—	—	—	—	
6°	—	5°55'	—	—	
8°	—	7°29'	—	—	
10°	8°11'	8°57'	8°34'	7°20'	+1°14'
12°	—	10°15'	—	—	
14°	10°00'	—	—	—	
16°	11°18'	—	—	—	
18°	12°40'	—	—	—	
20°	14°13'	15°08'	14°40'	14°29'	+0°11'
22°	—	16°30'	—	—	
24°	—	17°55'	—	—	
26°	—	19°14'	—	—	
28°	—	20°27'	—	—	
30°	20°04'	21°49'	20°56'	21°15'	+0°41'
32°	—	23°04'	—	—	
34°	23°07'	24°20'	—	—	
36°	24°10'	25°22'	—	—	
38°	25°21'	26°31'	—	—	
40°	26°33'	27°33'	27°03'	27°27'	-0°24'
42°	27°33'	28°45'	—	—	
44°	28°34'	29°44'	—	—	
46°	29°30'	30°41'	—	—	
48°	30°40'	31°42'	—	—	
50°	31°34'	32°33'	32°04'	32°50'	-0°46'
52°	32°33'	33°32'	—	—	
54°	33°22'	34°07'	—	—	
56°	34°20'	34°58'	—	—	
58°	35°04'	35°56'	—	—	
60°	35°49'	36°38'	36°13'	37°24'	-1°11'
70°	38°35'	37°40'	38°08'	40°39'	-2°31'
75°	—	39°15'	—	—	
80°	—	40°00'	—	42°43'	-2°43'

³ See Figure 7.

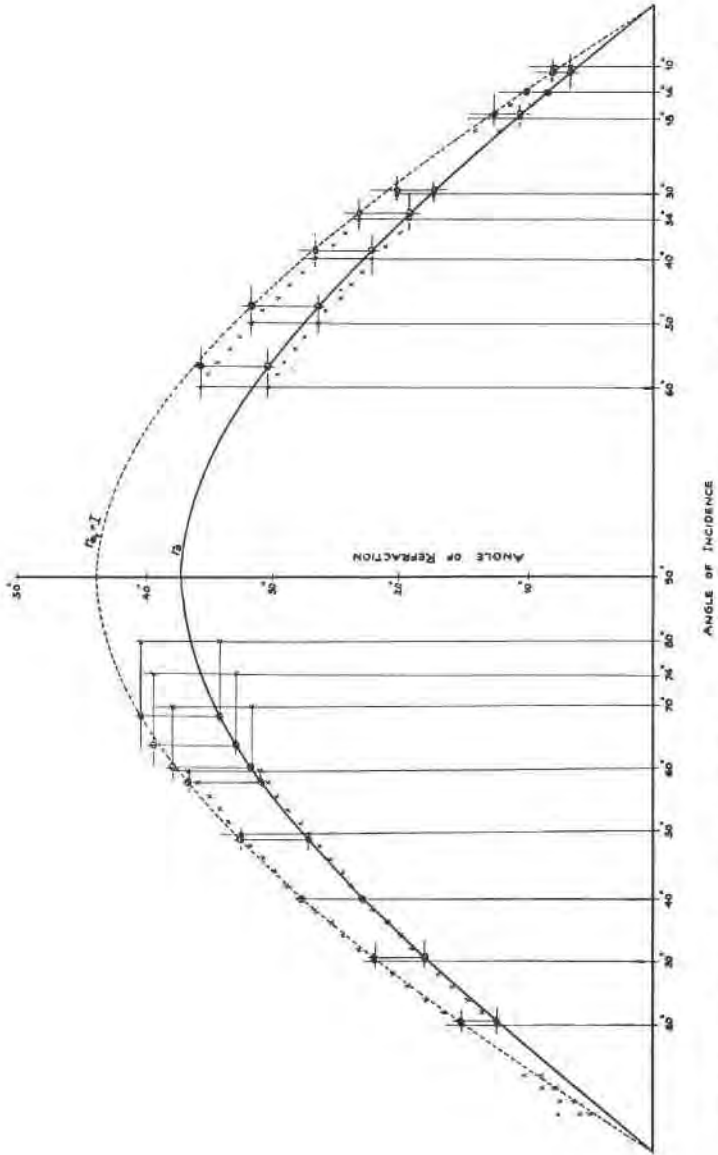

FIG. 5. Graph showing observational data and theoretical curves for the values of the ordinary and extraordinary rays transmitted through a calcite half-cylinder, in which crystallographic c lies in the diameter face of the half-cylinder. Errors due to irregularity of the test-piece have been corrected graphically. The circles indicate the points thus corrected. The solid curve is for the ordinary ray; the dashed curve is for the extraordinary ray, and crosses indicate actual readings.

of the observational data, and as to how the handmade test pieces depart from true proportions, shaping, and optical orientation.

The angular measurements of the refracted e ray emerging from the calcite half-cylinder did not conform to values that might be expected at first thought from Huygen's wave construction. In accordance with Huygen's construction it would be expected that the e ray would have a smaller angle of refraction than that of the o ray (Fig. 6). However, in the direct measurements it was found that the measured angle of re-

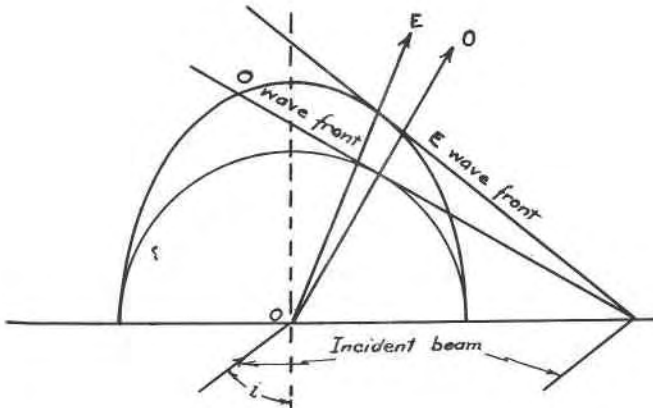

FIG. 6. Huygen's construction showing the paths of ordinary and extraordinary rays in an anisotropic medium and the resulting wave fronts.

fraction for the e ray was considerably greater than that of either the o ray or of the wave normal of the e wave front, as calculated from theoretical values. The reasons for this discrepancy were made apparent in subsequent observations.

In measuring the refraction of transmitted light through the circular half-cylinder the authors noted an unexpected behavior of the o and e rays. It was first noted that if the vertical cross-hair of the telescope was centered upon the distant light image with the o vibration direction and the focus changed to the surface of the cylinder, by throwing the accessory lens into the system, the vertical cross-hairs remained centered on the image. However, when the telescope was focused and centered upon the distant e image and the accessory lens thrown into the system, it was found that the image was thrown out of line with the vertical cross-hair of the telescope. Although the field was reversed due to the action of the accessory lens, the e image did not reverse its position in the field but remained on the same side of the o image in the observed field. Moreover, when an attempt was made to center the telescope on this image, the image would move a short distance in front of the vertical

cross-hair, and then extinguish before the telescopic cross-hair could be centered upon it.

These observations indicated that the o ray came directly through the circular half-cylinder and left normal to the surface. The e ray, however, was refracted at the surface of the half-cylinder and crossed the path of the o ray. This conclusion was demonstrated simply by the use of a small shield of copper sheeting. This shield was inserted across the field of view between the half-cylinder and telescope at different distances from the rear surface of the half-cylinder, and the order of disappearance of the images noted (Fig. 7). At position a , the copper shield being in con-

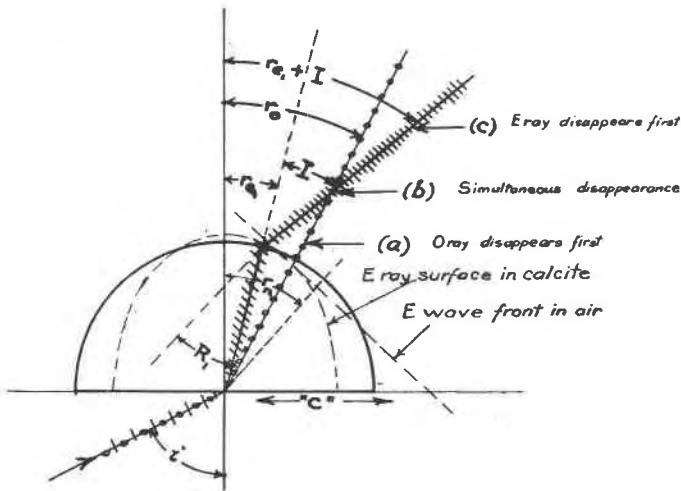

FIG. 7. Diagram to indicate the refraction of the extraordinary wave normal as it left the circular half-cylinder of calcite.

tact with the rear surface of the half-cylinder, the o image was the first to disappear. When the shield was inserted in position b , a few mm. from the rear surface of the half-cylinder the two images disappeared simultaneously, and in position c , 10 cm. from the surface of the half-cylinder, the e image was the first to extinguish.

This phenomenon was examined also by projecting the two light images onto a translucent paper screen which was then moved outward from the calcite surface. At the surface of the calcite two distinct images were observed on the screen. As the screen was moved outward these images were observed to converge, and at about 3 mm. distance from the surface the images coalesced. Beyond this point of coincidence the images separated and continued to diverge with increased distance from the calcite surface.

These demonstrations proved conclusively that the *o* ray had traveled through the anisotropic medium, struck the calcite-air contact normal to the surface and emerged without refraction at that surface. The wave front of the ordinary ray is parallel to the tangent of the circular surface of the calcite. The *e* ray, however, traveled through the anisotropic medium, struck the calcite-air contact normal to the surface but was refracted at the surface. The explanation of this refraction depends upon the vibration of the electro-magnetic disturbances of the *e* ray being oblique to the ray, although parallel to the tangent of the elliptical *e* ray surface, which is the extraordinary wave front. Consequently, the vibration directions of the *e* ray, being parallel to the extraordinary wave front were oblique to the ordinary wave front, and as a result suffered refraction at the calcite-air surface of the half-cylinder. This refraction can be calculated, and thereby the observed values may be checked.

Calculations of refraction of e ray.—Malus discovered the relationship $O/E \tan r_0 = \tan r_e$, where *O* and *E* are the standard velocities of the ordinary and extraordinary rays respectively, $\tan r_0$ is the angle of refraction of the *o* ray, and $\tan r_e$, the angle of refraction of the *e* ray (Fig. 7). It can also be shown that $E/O \tan r_0 = \tan r_n$, where r_n is the angle of refraction of the extraordinary wave normal. Then $r_n - r_e =$ the angle of refraction, R_1 , of the extraordinary wave normal at the calcite-air surface at the point of emergence of the extraordinary ray. The index of refraction at this point can be determined from the relationship $\mu_{e_1} = \sin i / \sin r_n$, where *i* is the angle of incidence of the light upon the prism face of the half-cylinder. *I*, the direction taken by the *E* ray disturbance as it emerges from the calcite into air, can be calculated from Snell's Law: $\sin I = \sin R_1 \mu_{e_1}$. The computations are summarized below.

The similarity between the observed and calculated values will be noted (Fig. 5). Examination of the data show small but consistent departures from agreement between observation and theory. With the aid of the data provided by observations of the ordinary ray, one may see that there is a definite lack of true shape in the test-piece. Furthermore, it may be noted that the direction and amount of discrepancy disclosed by the ordinary ray observations nearly coincide with the apparent errors in the data derived from the extraordinary ray observations. By a simple change in the recorded angle of incidence to correspond to the actual angle of refraction, based on the ordinary ray data, one may shift also the position of the extraordinary ray readings to correspond to the same angle of incidence. This has been done for the points recorded, with the result that the observed data of the extraordinary ray became amazingly close to their theoretical values. This correction, which seems quite

TABLE OF COMPUTATIONS

i	r_0^*	r_{e_1}	r_0	$r_n - r_{e_1} (= R_1)$	μ_{e_1}	I	$r_{e_1} + I^*$
10°	6°01'	5°24'	6°42'	1°19'	1.4801	1°57'	7°20'
15°	8°59'	8°04'	10°00'	1°56'	1.4903	2°53'	10°57'
20°	11°54'	10°42'	13°14'	2°32'	1.4941	3°47'	13°14'
25°	14°46'	13°18'	16°23'	3°05'	1.4997	4°37'	17°55'
30°	17°33'	15°50'	19°26'	3°36'	1.5028	5°25'	21°15'
35°	20°14'	18°17'	22°21'	4°04'	1.5084	6°09'	24°26'
40°	22°49'	20°40'	25°09'	4°29'	1.5125	6°47'	27°27'
45°	25°15'	22°55'	27°45'	4°50'	1.5185	7°21'	30°16'
50°	27°31'	25°07'	30°10'	5°03'	1.5243	7°43'	32°50'
55°	29°36'	26°59'	32°22'	5°23'	1.5301	8°15'	35°14'
60°	31°29'	28°52'	34°20'	5°28'	1.5355	8°31'	37°24'
65°	33°08'	30°20'	36°04'	5°44'	1.5396	8°51'	39°11'
70°	34°31'	31°45'	37°30'	5°45'	1.5446	8°54'	40°39'
75°	35°38'	32°43'	38°39'	5°56'	1.5465	9°12'	41°55'
80°	36°26'	33°36'	39°28'	5°52'	1.5494	9°07'	42°43'
85°	36°56'	33°58'	39°59'	6°01'	1.5504	9°21'	43°19'

* The data for r_0 and for $r_{e_1} + I$ were used to construct the theoretical curves in Figures 5, 8 and 10.

logical and legitimate, appears to bear out completely the analysis of the phenomena here advanced, and to confirm the accuracy of the computations involved.

Elliptical half-cylinder.—Measurements of the refraction angles for varied angles of incidence in the calcite elliptical half-cylinder were recorded only for the extraordinary ray. The ordinary ray of course suffered added refraction at the calcite-air surface but was disregarded as not being pertinent to this study.

READINGS FROM ELLIPTICAL HALF-CYLINDER OF CALCITE
 REFRACTION OF WAVE NORMAL⁴

i	Erect (1)		Inverted (2)	
	Right	Left	Right	Left
10°	7°43'	6°44'	7°08'	7°19'
15°	11°03'	10°01'	10°31'	10°39'
20°	14°05'	13°06'	13°35'	13°40'
25°	17°01'	15°59'	16°26'	16°40'
30°	20°08'	19°01'	19°28'	19°42'
35°	23°11'	21°53'	23°18'	23°35'
40°	25°41'	24°30'	25°04'	25°15'
45°	28°20'	26°40'	27°44'	27°53'
50°	30°12'	29°02'	30°07'	—
55°	32°13'	30°58'	32°11'	—
60°	33°45'	33°03'	33°55'	—
65°	35°08'	34°25'	35°11'	—
70°	35°57'	—	36°00'	—
80°	36°41'	—	—	—

COMPARISON OF OBSERVATION WITH THEORETICAL VALUES

i	Calculated values of r_n	Average readings (Position 1)	Difference between observation and Theory	Average readings (Position 2)	Difference between observation and theory
10°	6°42'	7°14'	+0°31'	7°13'	+0°32'
20°	13°14'	13°36'	+0°21'	13°38'	+0°24'
30°	19°26'	19°34'	+0°08'	19°35'	+0°09'
40°	25°09'	25°06'	-0°03'	25°09'	-0°00'
50°	30°10'	29°37'	-0°43'	30°07'	-0°03'
60°	34°20'	33°24'	-0°56'	33°55'	-0°25'
70°	37°30'	35°51'	-1°39'	36°00'	-1°30'
80°	39°28'	36°41'	-2°47'	—	—

⁴ Readings were taken only on the refracted images of the e ray; these represent the angle of refraction of the wave normal at the point of emergence. Four sets of readings were obtained, one in each quadrant for the erect half-cylinder, and one in each quadrant of the same half-cylinder in an inverted position.

Inasmuch as the extraordinary ray emerged with very little or no refraction, it follows that the wave normals must have emerged normal to the calcite-air surface (Fig. 9). The extraordinary ray of course traveled through the elliptical half-cylinder in a path similar to that taken in the circular half-cylinder for the same angle of incidence. However, the e ray emerged from the elliptical half-cylinder normal to the calcite-air surface

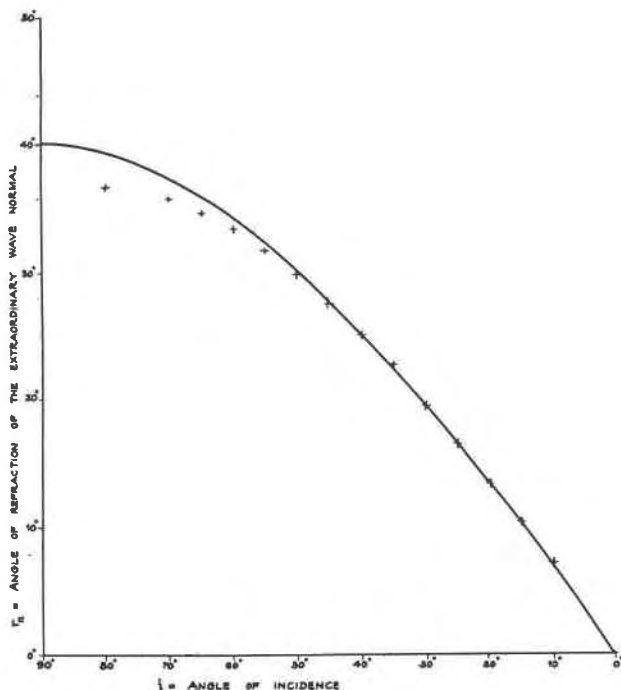

FIG. 8. Graph showing the actual readings plotted against the curve, representing observed and theoretical values for the refraction of the wave normal in calcite. These readings were made from an elliptical half-cylinder, so proportioned that the axes of the ellipse are the same relatively as the velocity of the ordinary and extraordinary rays.

and also normal to the extraordinary wave front. Consequently, the angular readings obtained from the extraordinary ray at the point of emergence from the elliptical half-cylinder gave directly the refraction of the extraordinary wave normal, r_n . The results obtained from the measurements of the e ray corresponded very closely with the respective theoretical values as calculated for the normal to the e wave front at the point of emergence of the e ray (Fig. 8). This similarity proves that the half-cylinder very closely approximated the shape of the extraordinary ray surface.

The differences between observation and computed values are to be

ascribed mainly to the fact that the ellipse was not quite true in shape, being 35/1000th (35 mils) of an inch too long in the major axis for the theoretically correct dimensions. The measurements were actually 770 mils in diameter and 463 ± 4 mils high. The true proportions require 428 mils for the height. The specimen was measured with a micrometer screw. Furthermore, optical measurements with a petrographic microscope showed that the diameter face, supposedly parallel to the crystallographic c , was actually inclined $2^\circ \pm \frac{1}{2}^\circ$ to the correct direction. During

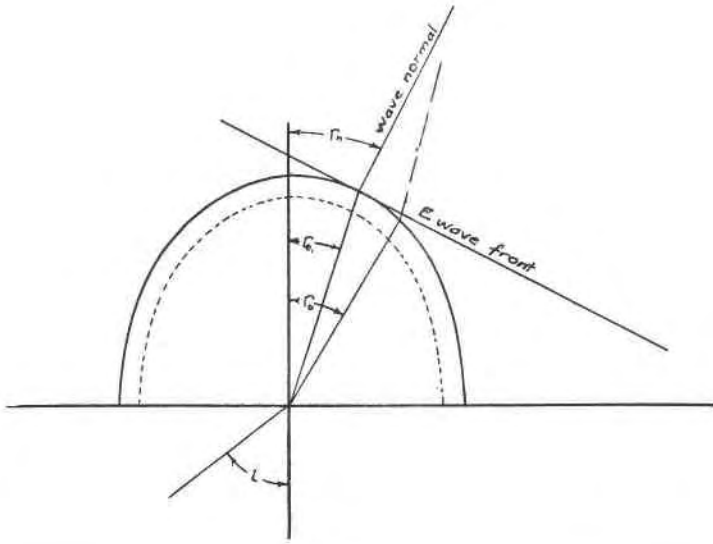

FIG. 9. Diagram following Huygen's construction to show that from an elliptical test-piece, whose curvature equals that of the ray surface ellipse, the extraordinary wave normal will emerge without refraction at the calcite-air surface.

an attempt to regrind this test-piece to correct the imperfections, unfortunately it was cracked too seriously to afford further readings. In spite of its physical shortcomings, the elliptical test-piece seems to have served to demonstrate that the ray surface in calcite is an ellipse, and that the wave normal leaves the ellipse normal to the tangent at the point of emergence.

Bausch and Lomb optically true half-cylinder.—In order to check the accuracy of the results obtained from the hand-made circular half-cylinder and to estimate the relative accuracy which could be expected from the elliptical half-cylinder with dimensions similar to those of the hand-made specimen (Fig. 1) Bausch and Lomb prepared an optically true half-cylinder. It was found that the average readings from the hand-made cylinder were consistently higher than the refraction readings on the Bausch and Lomb piece.

BAUSCH AND LOMB CIRCULAR HALF-CYLINDER OF CALCITE⁵
 ANGLE OF REFRACTION OF THE ORDINARY RAY

i	Right	Left	Average	Calculated	Difference between observation and Theory
10°	6°03'	6°00'	6°01'	6°01'	0°00'
15°	8°57'	8°52'	8°55'	8°59'	-0°04'
20°	11°56'	11°50'	11°53'	11°54'	-0°01'
25°	14°43'	14°37'	14°40'	14°46'	-0°06'
30°	17°30'	17°24'	17°27'	17°32'	-0°05'
35°	20°10'	20°04'	20°07'	20°14'	-0°07'
40°	22°36'	22°30'	22°33'	22°49'	-0°16'
45°	25°02'	24°55'	24°59'	25°15'	-0°16'
50°	27°16'	27°19'	27°17'	27°31'	-0°14'
55°	29°06'	29°20'	29°13'	29°36'	-0°23'
60°	30°55'	31°15'	31°05'	31°29'	-0°24'
65°	32°26'	32°51'	32°38'	33°08'	-0°30'
70°	33°39'	34°08'	33°24'	34°31'	-0°07'
75°	34°27'	35°06'	34°46'	35°38'	-0°52'
80°	34°56'	35°30'	35°13'	36°26'	-1°13'
85°	34°37'	35°24'	35°00'	36°56'	-1°56'
89°30'	—	35°21'	—	—	—

ANGLE OF REFRACTION OF THE EXTRAORDINARY RAY⁶
 ($r_{e_1} + I$)

i	Right	Left	Average	Calculated	Difference between observation and Theory
10°	7°23'	7°20'	7°21'	7°20'	+0°01'
15°	11°03'	10°57'	11°00'	—	—
20°	14°33'	14°27'	14°30'	14°29'	+0°01'
25°	18°00'	17°54'	17°57'	—	—
30°	21°16'	21°10'	21°13'	21°15'	-0°02'
35°	24°27'	24°21'	24°24'	—	—
40°	27°25'	27°20'	27°23'	27°27'	-0°04'
45°	30°07'	30°02'	30°05'	—	—
50°	32°41'	32°45'	32°43'	32°50'	-0°07'
55°	34°55'	35°07'	35°01'	—	—
60°	36°57'	37°15'	37°06'	37°24'	-0°18'
65°	38°36'	39°04'	38°50'	—	—
70°	40°00'	40°30'	40°15'	40°39'	-0°24'
75°	40°53'	41°31'	41°12'	—	—
80°	41°28'	42°13'	41°50'	42°43'	-0°53'
85°	41°13'	42°00'	41°36'	—	—
89°30'	—	41°58'	—	—	—

⁵ Readings were made with sodium light.⁶ See Figure 7.

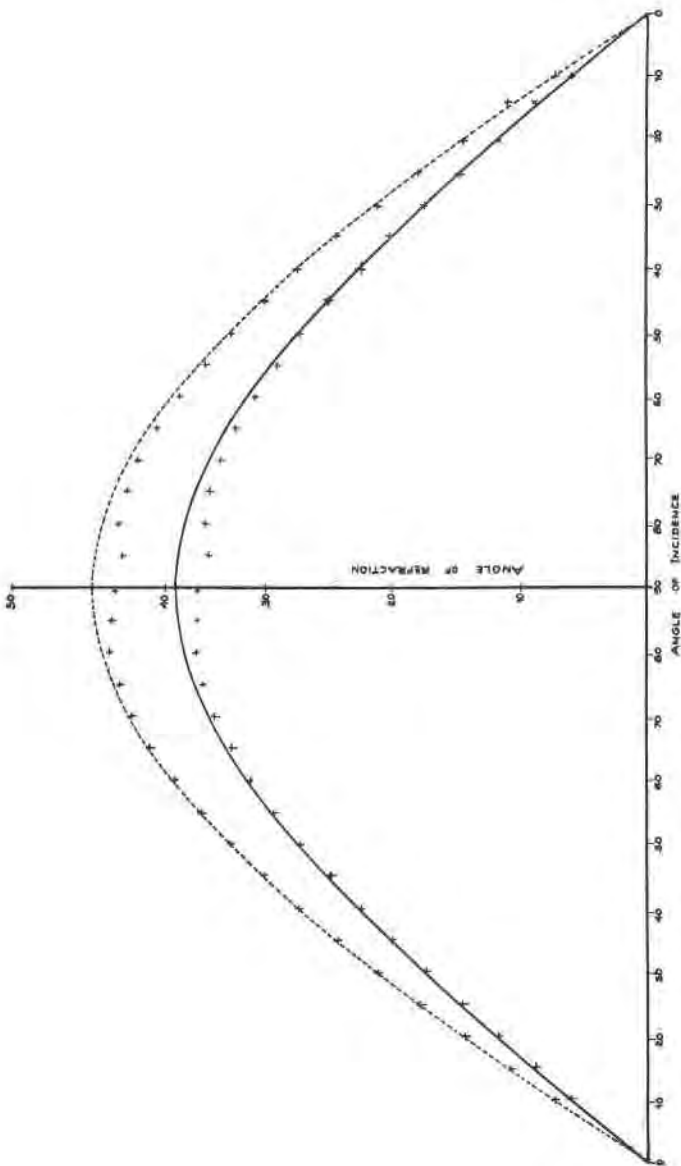

FIG. 10. Graph showing data and theoretical values from the ordinary and extraordinary rays when transmitted through a nearly optically true calcite half-cylinder. The test-piece was provided by the Bausch and Lomb Optical Company. This may be compared with Fig. 5. Note that much fewer corrections are required to reconcile observations with theory.

There seems to be a definite tendency for the observed data to fall lower than their theoretical value as the angles of incidence get higher. This shows clearly with all test-pieces. However, using the simple corrections applied to the first cylinder also to this second piece, close agreement results. A similar degree of error should be expected in the elliptical half-cylinder observations. There were no corrections made in this instance, but the smoothness of the curves derived by plotting the data, and the close correspondence of these readings to the theoretical values, indicate that the experiments thoroughly confirm the theoretical analysis.

CONCLUSIONS

These experiments furnish a simple and conclusive demonstration of the relation between the directions of the ordinary and extraordinary rays and wave normals and the corresponding indices of refraction in anisotropic media. However, the actual making of the test-pieces, provided one has suitable calcite crystals, is a procedure requiring considerable care and patience.

REFERENCES

- TUNELL, GEORGE, AND MOREY, GEORGE W., Some correct and some incorrect statements of elementary crystallographic theory and methods in current text-books: *Am. Mineral.*, **17**, 365-380 (1932).
- WOOSTER, W. A., *A Text-book on Crystal Physics*. Cambridge (1938).