

CUTTING SCHEMES FOR QUARTZ CRYSTALS

SAMUEL G. GORDON* AND WILLIAM PARRISH†

CONTENTS

	Page
Abstract.....	347
Introduction.....	348
Acknowledgments.....	351
Mounting Quartz for Cutting.....	351
Single Mount Cutting Schemes for Small Quartz.....	352
Flat Lay Cutting.....	352
Direct Wafering.....	352
Vertical Glass Mount.....	354
Transfer Jig Method.....	354
Dop Method.....	355
The X-Block, Wafering Procedure for Small Quartz.....	355
Coordination of Saws, X-Ray Apparatus and Orientation Devices.....	363
Procedure for Small Defaced Quartz.....	363
Cutting Schemes for Large Quartz.....	367
Z-Section, Y-Bar Method.....	368
Thick Z-Section, X-Block Method.....	369
X-Section, Complementary Bar Method.....	369
Complementary BT-Section Method.....	369
Complementary Cylinders.....	370

ABSTRACT

The various schemes for cutting small, large and defaced quartz are critically reviewed. In the single mount or direct wafering methods, the quartz is set up once-for-all and wafered. These methods are favored by "production" men because they involve a minimum number of operations. They usually require orientation by hand and polarity determinations and the use of transfer jigs. The cutting accuracy and yield are low.

In the X-block method, the crystal is mounted on a prism or rhomb face and a pair of X-planes cut. After etching, the block is oriented by parallelogram light figures, which are fool-proof, and wafered. The method has greater precision and permits the maximum utilization of electrically and optically twinned quartz. It does not require the use of jigs, the cutting accuracy is high, and it allows an easily visualized set of orientation rules and accurate control of the dicing angle. Flawed areas may be painted out to avoid useless sawing and processing. A pair of Z-planes is first cut on defaced quartz, Y determined with the triangular light figures and then handled as faced quartz.

Large faced or defaced quartz (greater than 1000 gms.) is cut into thick Z-sections and then into X-blocks which are wafered. If the quartz is of exceptional quality, it is cut into thin Z-sections, the width of the desired blanks, then into Y-bars which are cut into blanks.

* The Academy of Natural Sciences, Philadelphia, Pa.

† North American Philips Co., Inc., Research Laboratory, Irvington, N. Y.; mail address, Dobbs Ferry, N. Y.

INTRODUCTION

A surprising variety of orientation techniques and cutting schemes have been devised for cutting quartz crystals. In this paper, only the strategy of the cutting schemes and the more successful procedures will be described.

Since the majority of the crystal cuts are in the prism-rhombohedral zone and at angles near either the r or z rhombohedral faces, it will be seen that there are two general geometrical approaches to arrive at the cutting plane.

(1) By mounting the crystal on a *prism edge* and rotating it about the now vertical X-axis to the desired cutting angle.

(2) By mounting the crystal on a *prism face* and tilting it (rotating about a horizontal X-axis) until the cutting plane is parallel to the saw blade.

To some extent, the procedures are determined by the available sawing equipment. There are two general types of saws:

(1) Converted milling machines which have little or no adjustment and require that the quartz be *preset* before it is placed on the saw; and

(2) The Felker type¹ which have graduated tables with horizontal and vertical angle movements and permit angular adjustments of the crystal as indicated by x -ray measurements of a test cut piece.

With respect to cutting quartz, there are two opposed schools of thought:

(1) The single mount or direct wafering set up, in which the quartz is preset in a cutting position once and for all, and sliced into wafers. These include flat lay cutting, "baloney slicing," vertical glass mount, transfer jig method and the dop method.

(2) The preliminary cutting of a precise X-plane, upon which the crystal is remounted and then sliced into wafers as in the X-block, wafering method.

The direct wafering approach is favored by most "production" men because it involves a minimum number of operations. If quartz were an untwinned and flawless substance, and were it really possible to orient it with precision once and for all, such a short cut would be justified.² In

¹ Including converted drill presses to which rotating tables, graduated circles and tilt table platforms have been added.

² Tilts of the saw table are often made in an effort to make angular corrections in three directions. Users of a universal stage will appreciate the problem involved and the results likely to be obtained by a saw operator who could hardly be expected to know that a crystallographic direction of the quartz must be brought parallel to the axis of rotation before a tilt is attempted. Elaborate arc movements within yokes carrying the crystal, gimbals and the like have been devised to correct the "once-for-all" set-ups.

actual practice a large number of saws are required, and the efficiency is low for once a crystal is set up, good and bad portions are sliced, since it is not possible to discriminate between twinned and untwinned, or flawed and usable portions at the saw. Furthermore, the cutting accuracy is low due to the instability of the jigs and irregularity of the entering surface.

The second approach, the X-block method, involves an additional cutting, etching, reorientation and cementing operation.³ This is justified

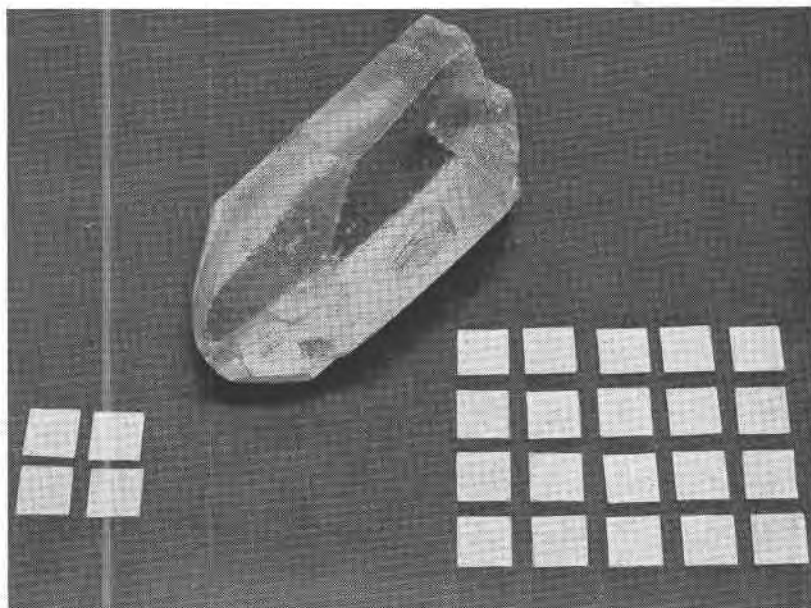

FIG. 1. The yield in most of the crystal plants in the country in 1943 of BT crystals varied from 20 to 4 units shipped per pound of raw quartz cut. On a weight basis this yield is considerably less than 1%.

by (1) greater precision, since a true X-plane is cut at the start to assure that the X-axis is in the plane of the blanks; (2) foolproof orientation by means of the parallelogram light figure on the etched X-block, thus eliminating hand and polarity determinations; (3) a maximum utilization of electrically and optically twinned quartz; (4) elimination of sawing of useless flawed and twinned parts of a crystal; (5) generally only the horizontal angle need be adjusted at the saw—the vertical angle correction,

³ In spite of these additional steps, manufacturers using this method use fewer saws and employees and produce more crystals per pound of quartz per man per day than those using the direct wafering methods.

if required, is small; (6) the cutting accuracy in wafering is greater because the blade enters perpendicular to a smooth surface and there are no jigs to reduce stability; (7) an easily visualized set of rules for orientation and correlation of x -ray goniometer readings with saw table rotations; (8) accuracy in control of the dicing angle with respect to the reference X-planes on the wafers. The method is simple, straightforward and does not require the use of jigs. After an additional preliminary operation de-faced quartz may be processed in exactly the same way.

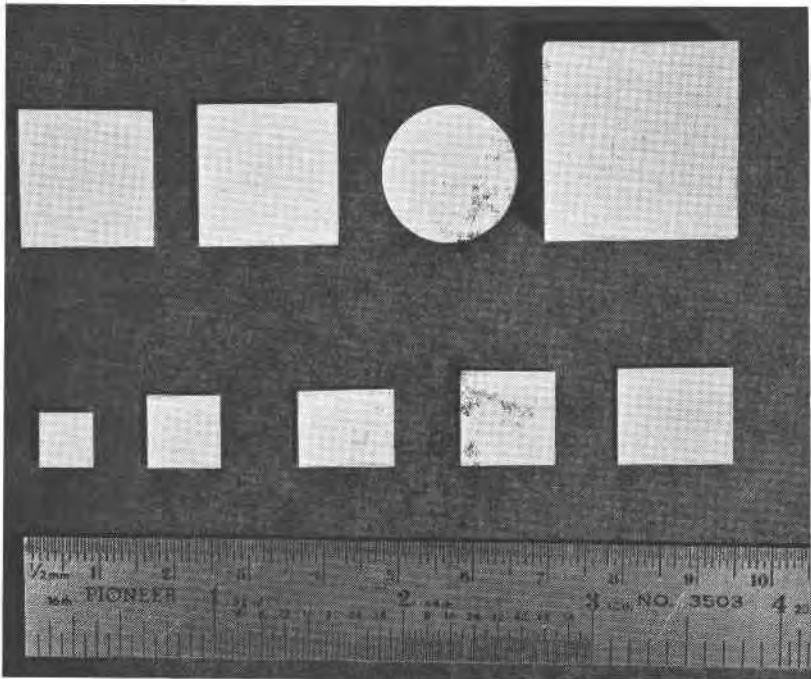

FIG. 2. Finished oscillator-crystals vary in size from approx. $\frac{1}{4}$ " to $\frac{3}{4}$ " square. Tendency is towards smaller sizes. Circular plates are used mainly abroad. Large plate in upper right is for ultrasonic work.

Although achievements were considerable in meeting military requirements for millions of crystal units a year, the efficiency of the industry calculated on the basis of the number of finished accepted crystals per pound of raw quartz cut was very low, but is now gradually increasing. The yield in 1943 for BT crystals for all qualities of raw quartz used in most of the crystal plants in the country varied from approximately 20 units to 4 units or even less (Figs. 1 and 2) shipped per pound of quartz cut. From the point of view of the weight lost, this represents an efficiency of *considerably less than 1%*. The largest loss is due to the thick-

ness (0.045" to 0.070") of the diamond blades which cause losses up to 70%–80% in the wafering operation.

Acknowledgments. Many of the procedures here described are based upon methods developed in the quartz crystal industry. Mr. J. N. Bagwell, Commercial Crystal Co., Lancaster, Pa., collaborated in the early development work on the X-block method, and Miss Judith Weiss, Bryn Mawr College in the procedure for defaced quartz.

Fig. 4 is from W. L. Bond, *Bell Syst. Tech. Jour.*, **22**, 224 (1943). Fig. 8 was obtained from Reeves Sound Laboratories, Inc., New York City. Dr. O. Ivan Lee of William B. Ogush, Inc., New York City, contributed information on the dop method and Fig. 9.

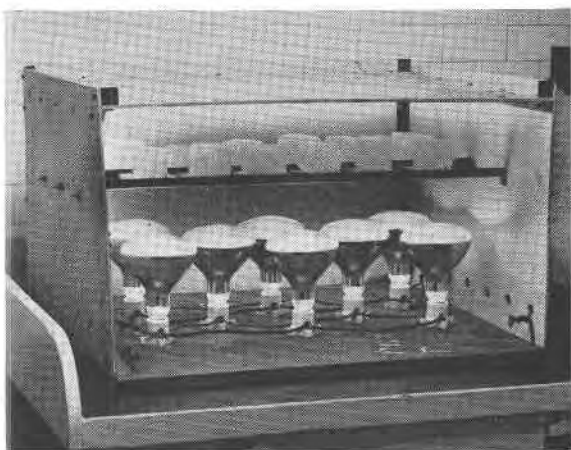

FIG. 3. Infrared lamp oven used for setting thermoplastic cement in mounting crystals.

MOUNTING QUARTZ FOR CUTTING

Some of the difficulty in the earlier period of crystal cutting was due to unsatisfactory cementing materials, which included plaster-of-paris, shellac, optical pitch, "iron glue," sauerisen, mixtures of plaster-of-paris, rosin and wax, water glass and whiting, and other substances. An ideal cement proved to be a thermoplastic.⁴ This cement may be thinned with acetone and dispensed from a small oil can directly to a piece of plate glass for mounting. The cement becomes tacky after standing about ten minutes in air. The quartz is placed on the cement, and Z set parallel to the reference edge of the glass plate with the mounting stauroscope. Infrared lamps⁵ are used to set the cement at a temperature of approximately 250° F. (Fig. 3).

⁴ General Electric Co., Bridgeport, Conn. Thermoplastic cement, ZV5057.

⁵ General Electric, Wabash, Westinghouse, 115 V 250 W, reflector heat lamps with internal metallic reflectors.

Crystals have been mounted on various sorts of material for sawing. These included plaster blocks, plywood, masonite, metal and glass. The most satisfactory material is $\frac{1}{4}$ " thick plate glass cut into 3" by 5" rectangles. A straight reference edge on one long side is quickly ground on a large lap. The advantages of glass are its (a) rigidity, (b) will not damage diamond blade, (c) cheapness.

SINGLE MOUNT CUTTING SCHEMES FOR SMALL QUARTZ

The five methods described below are typical of the many schemes for cutting quartz by a single mount "once-for-all" method. In most of these methods, the orientation is carried out with the aid of an electrical polarity determination of X and the hand of the crystal in a polariscope. Since left-hand crystals had to be turned on the saws in the opposite direction from the right-hand crystals, various methods were devised to avoid confusion. In some plants a large R or L was painted on each saw, and it received quartz of only one hand.⁶

Flat Lay Cutting. One of the oldest cutting schemes is to mount the crystal on a prism face, the mount placed on a jig and transferred to a conoscope where the optic axis is made horizontal. The mount is transferred to the saw platform whose vertical angle has been preset to the desired wafering angle. The blade position is fixed and the crystal wafered by cross-cutting (Fig. 4). Larger crystals were first cut into Z-sections, the sense of the cut and Y-axis determined by *x*-rays, and the section wafered in the same manner.

The great disadvantage of this method is that the saw enters a slanting surface (the prism edge is at an angle to the blade) so that the blade drifts. It is therefore necessary to cut the wafers very thick (0.090" thick compared with 0.045" in the X-block method) and true each wafer by cementing on rather expensive specially designed cylindrical jigs which are corrected by *x*-rays and the wafers trued on an ultralap.

Direct Wafering. This method is also called "*baloney slicing*" in the industry. The crystal is sometimes held in a clamp and tilted up until the plane of the cut is parallel to the saw blade (Fig. 5). More often the crystal is mounted on a prism edge with the X-axis vertical and the plane

⁶ When *x*-ray checks were introduced, a visitor might have been justified in thinking that a political revolution was imminent as sawyers thrust quartz wafers at the *x*-ray operator, crying "I am a left" or "I am a right." Elsewhere the operators of saws cutting left quartz were distinguished from those cutting right quartz by differently colored—but vivid and unmistakable—smocks. In still another plant, where the girls got careless in setting up quartz marked simply R or L, a psychological, if sentimental, approach was tried with great success: green paper hearts were pasted on left quartz crystals, and red paper hearts on the right crystals.

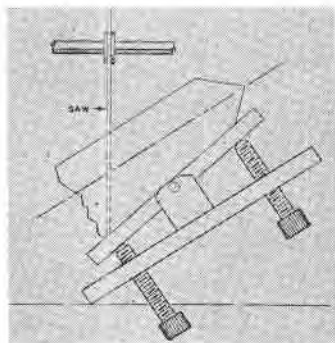

(4)

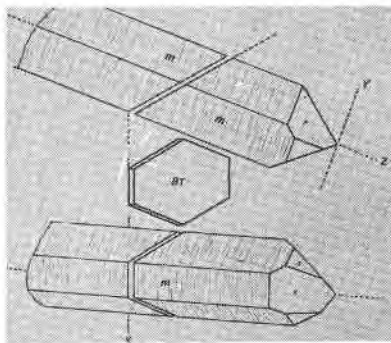

(5)

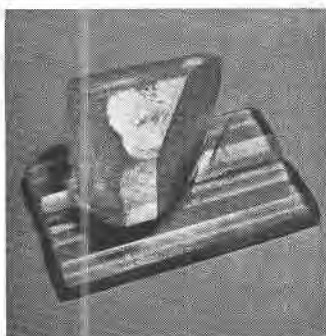

(6)

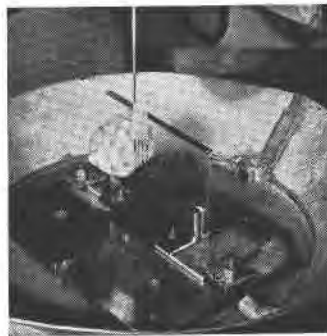

(7)



(8)

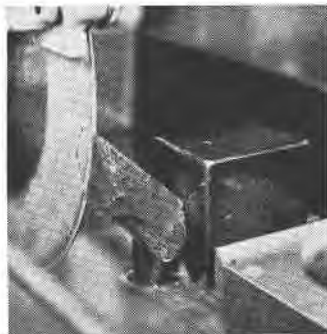

(9)

FIGS. 4-9. Single mount cutting schemes. (4) Flat lay cutting (Bond, *Bell Syst. Tech. Jour.*, 22, 224, 1943). (5) Direct wafering. (6) Direct wafering by mounting crystal on prism edge in 120°V groove in glass plate. (7) Vertical glass mount. (8) Transfer jig. (9) Dop method.

of the cut made parallel to a reference edge of a masonite or plywood board. The orientation is accomplished by setting the crystal in plaster-of-paris or thermoplastic cement mixed with sand, and pushed around until the prism striations are made vertical with the aid of a right-angle square. Sometimes 120° V's are cut in wood or glass (Fig. 6). The difficulty of mounting the crystal with X vertical was later solved by simply grinding away a prism edge, or cutting it off.⁷ This should not be confused with the precise cutting of a pair of such planes in the X-block method, for the latter is but one step in the inspection and reorientation of the crystal. The method requires identification of the major rhombohedron or determination of hand and polarity.

Vertical Glass Mount. The difficulty of setting up a quartz crystal with the X-axis vertical was overcome in the Chicago area by a novel scheme. The crystal is cemented on a prism face to a rectangular glass plate, with Z nearly parallel to the long reference edge. The divergence of Z from the reference edge was determined by a crossed Polaroid stauroscope using a photoelectric cell. Since the prism faces are irregularly developed, and therefore not parallel to Z, the divergence between Z and the plane of the glass plate on which the crystal is mounted was also found by turning the mount 90° on the stage. Being mechanically, rather than geometrically minded, the divergences were measured by feeler gauges rather than on a divided circle, and adjustments were made at the saw by similar coordinated gauges. The novelty of the method is that the glass plate is locked in the saw on its long edge (Fig. 7), i.e., with the plane of the glass perpendicular to the saw table. The blade cuts through the upper edge of the glass plate and then into the crystal.

Transfer Jig Method. The following description is typical of the schemes involving the use of a jig with more or less universal movements which is used for preorientation of the crystal by optical and/or x-ray methods and transferred to the saw for direct wafering. An approximate X-plane (11 $\bar{2}$ 0) is cut on one side of the crystal and one or both ends, perpendicular to Z, are also cut off to facilitate conoscope observations. The crystal is mounted with stick shellac on the X-plane on a circular fiber board which is clamped to the jig (Fig. 8). The jig is set on the track in the conoscope tank and the optic axis centered by a pair of adjusting screws and the hand determined. The jig is taken to a dark room and mounted in a special x-ray stand and the X-axis tilted to the vertical by adjusting another pair of screws until a pair of diffracted x-ray spots are centered on a fluorescent screen.⁸ The jig is locked on the saw table which

⁷ See for example, Johnson, C. E., Method of cutting quartz: *U. S. Patent Off.*, No. 2,264,698, Dec. 2, 1941.

⁸ The fluorescent screen method is used by few plants. In most cases the X-axis is oriented by triangular etch light figures on preliminary cut Z-planes or by x-rays using a Geiger counter tube.

is set at the cutting angle and wafered. Test cuts are corrected by further *x*-ray checks.

Dop Method. This is a scheme in which faced crystals are preset to the cutting angle and wafered directly. The BT-cut is $10^{\circ}47'$ (for $ZZ' = 49^{\circ}$) from the major rhombohedron *r*. This rhombohedron plane is carefully ground by hand until a precision protractor indicates that the plane angle has been reduced $10^{\circ}47'$, which requires craftsmanship. The ground plane is cemented with glyptal resin to a steel block held by a vise on a standard milling machine (Fig. 9). The crystal is fed into the saw and successive cross-cuts are made parallel to the original ground surface. There is no correction of the sawing angle and off-angle wafers must later be corrected by lapping.⁹

THE X-BLOCK, WAFERING PROCEDURE FOR SMALL QUARTZ

This is the most widely used and successful scheme for cutting quartz weighing up to 1000 gms. Larger quartz is first cut into thick Z-sections and then into X-blocks, or if it contains large flawless areas, into thin

TABLE 1. SCHEMES FOR PROCESSING VARIOUS TYPES OF RAW QUARTZ USING THE X-BLOCK, WAFERING PROCEDURE

Size (grams)	Faced or Defaced	Cutting Scheme
<100	Faced and Defaced	Not economically feasible to cut at this time.
100-1000	Faced	X-block, wafering method.
	Defaced	Cut Z-planes and remount for X-block, wafering method.
1000-2000	Faced	If quartz contains large flawless portions use Z-section, Y-bar method. Otherwise thick Z-section, X-block method.
	Defaced	Grind mounting face parallel to Z and cut as faced quartz.
>2000	Faced and Defaced	Cut into smaller pieces which can be handled as described in weight classes above.

Z-sections and then Y-bars, as summarized in Table 1. The procedures have been carefully studied and are given in sequence below. Orientation details are described in the preceding papers by the writers. Figures 10 to 15 illustrate the more important steps in the manufacturing scheme.

⁹ The method is useful in salvaging ends which have fallen off the glass mount and already have the wafering plane on one side.

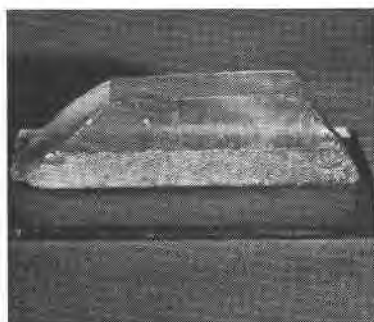

(10)

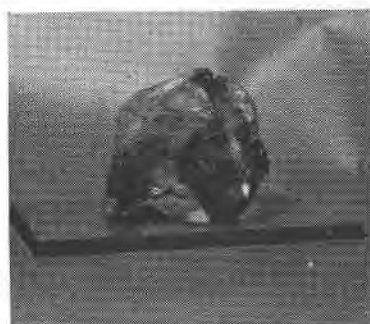

(11)



(12)

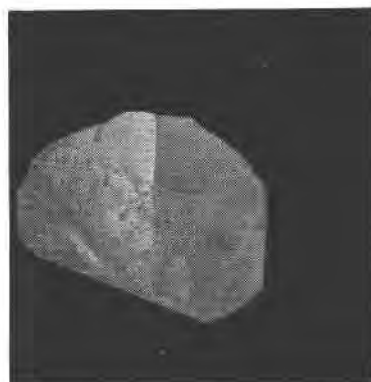

(13)

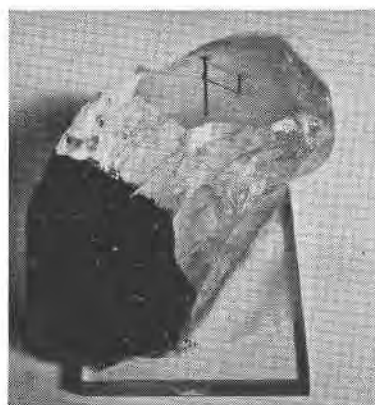

(14)

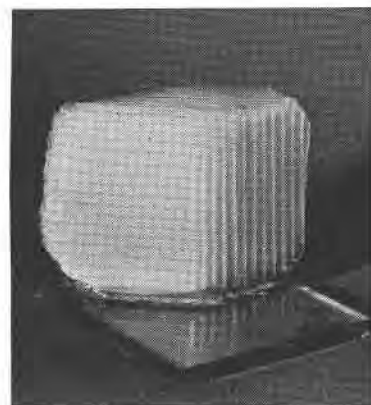

(15)

The crystal is mounted on a natural prism or apex face and X-planes (1120) cut on both sides. The X-block is etched to permit inspection, maximum utilization of electrical twinned areas and to permit orientation by the parallelogram light figure thus eliminating polarity and hand determinations. The crystal is remounted on one of the X-planes and rotated to the desired wafering angle. Since the diamond blade enters perpendicular to the flat surface of the X-plane, and no mounting jigs are used, thus assuring a stable mount, the maximum sawing accuracy is obtainable. Rules for the coordination of saws, α -ray goniometer and optical devices are summarized in Table 2.

1. *Inspection and Grading of Raw Quartz.* This subject is covered in detail in another paper.¹⁰ The inspectoscope is used to grade crystals and locate flaws before cutting. Optical twinning and physical imperfections such as bubbles, needles, etc., are found in this way.

It is good practice to sand blast and etch all crystals in concentrated ammonium bifluoride solution at room temperature for 10 to 20 hours before cutting so that the electrical twinning which is so prevalent can be identified. Sand blasting reduces etching time but large masses such as raw crystals and X-blocks should not be placed in hot etch solution which may crack them. Although hydrofluoric acid is better for this purpose than ammonium bifluoride solution because it produces a coarser and deeper etch, it is not recommended because of the industrial hazards involved. It is not always possible to determine the depth and position of all the electrical twinning in a crystal before cutting, but careful inspection has proven useful.

2. *Selection of Mounting Face.* The crystal may be mounted on any prism or rhombohedron face which is large and flat enough to properly support the crystal (Figs. 10 and 11) in cementing and cutting, and a line parallel to the optic axis is marked on the mounting face. The greatest yield will be realized by selecting a mounting face on the side of the crystal which shows no evidence of electrical twinning. The electrical twin then appears on the etched surfaces of the X-block (Fig. 13) which could be cut along the twin boundary and each side wafered as an individual crystal. If the electrical twin is mounted on the twin boundary the twin plane will be concealed in the X-block and the pin-hole light figure will be the same on both sides. It is then impossible to determine how the block should be oriented for wafering because of the difficulty in tracing the twin boundary.

The optical twin laminae may be parallel to any one or all three major rhombohedron faces. If optical twinning is observed in the inspectoscope to consist of a series of parallel bands extending across the crystal, a greater yield will be obtained by mounting on that face showing the most twin laminae. When the crystal is remounted on the X-plane, the BT-cuts which are approximately parallel to the major rhombohedron can be made be-

¹⁰ Gordon, Samuel G., The inspection and grading of quartz: *Am. Mineral.*, this issue; The inspection of quartz, *Manual for the Manufacture of Quartz Oscillator Blanks, Supp. No. 2*, Office of the Chief Signal Officer, War Dept., Washington, D. C., July 1, 1943.

FIGS. 10-15. X-block, Wafering Method. Crystal is mounted on prism (10) or rhomb (11). X-planes cut to form an X-block (12). (13) Electrical twin may be cut along twin boundary and each part individually wafered. (14) X-block remounted for wafering and flawed portions painted out to avoid useless sawing. (15) Wafer "comb."

tween rather than across the twin laminae (Fig. 16). The rule fails for AT-crystals which are approximately parallel to the minor rhombohedron for then one cannot help cutting across the twin laminae. If the optical twinning is close to one side of the crystal, it is better to mount it so that side is cut away in cutting the X-planes.

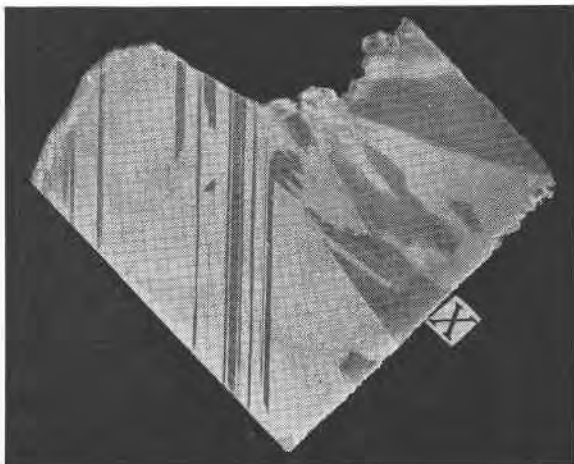

FIG. 16. This wafer as cut will yield no blanks. If the quartz had been set up with the optical twin laminae vertical (for these are parallel to another X-axis), it would have been possible to cut some usable wafers from between the twin laminae.

3. *Mounting for Cutting X-Planes.* The crystal is mounted with its optic axis parallel to the long reference edge of a piece of thick plate glass (usual size, 3"×5") with thermoplastic cement. After the cement becomes tacky the mount is transferred to the stage of a mounting stauroscope and the reference edge of the glass placed flush against the reference edge on the stage. The latter has been set parallel to the plane of polarization of one of the Polaroids. The crystal is shifted to the extinction position so that the optic axis of the crystal is now closely parallel to the reference edge of the glass plate. The mount is then transferred to an infrared lamp oven and baked about an hour at 250°F. to harden the thermoplastic, and allowed to gradually cool to room temperature.

4. *Cutting X-Plane.* The mount is placed on the saw with the reference edge of the glass plate flush against the reference edge of the saw table which is parallel to the saw blade (saw table scales read 0°0' for both horizontal and vertical angle). A vertical arrow pointing up is marked on the outer surface of the crystal (side opposite the fresh cut side) and a thin test piece is cut from either side of the crystal. The blade must not be forced; the technique of sawing is described in detail in an accompanying paper.¹¹

5. *X-Ray Measurement of X-Plane.* Burrs must be removed from the fresh cut surface of the test piece to prevent errors in x-ray measurement. The x-ray goniometer is set with a standard to 0° for reflection from (11 $\bar{2}$ 0), $2\theta = 36^{\circ}34'$ for CuK α .¹² The test piece is placed

¹¹ Parrish, William, Methods and equipment for sawing quartz crystals: *Am. Mineral.*, this issue.

¹² Parrish, William and Gordon, Samuel G., Precise angular control of quartz cutting with x-rays: *Am. Mineral.*, this issue.

in the *x*-ray crystal holder with the fresh cut side toward the *x*-ray beam and arrow facing the operator. The arrow is pointed up for measuring the horizontal angle and to the left (if cut from the left side of the crystal) or the right (if cut from the right side of the crystal) to measure the vertical angle. The saw table must be corrected by the *same amount and direction* as indicated by the direct *x*-ray goniometer reading. Steps 4 and 5 are repeated until an X-plane within the tolerance limits is obtained. With proper equipment and some care only one correction is required to bring the cut to a tolerance of $\pm 15'$ to $30'$.

6. *Cutting Second X-Plane.* A second X-plane is cut on the other side of the crystal to make an X-block (Fig. 12). The procedure is the same as in steps 4 and 5.

7. *Etching of X-Block.* The X-block is removed from the glass plate by immersing the mount for an hour in acetone. The crystal is cleaned and etched as described in step 1.

8. *Inspection of Etched X-Block.* The block is inspected in a spotlight for both optical and electrical twinning. Usable electrical twinned areas are marked along the twin bound-

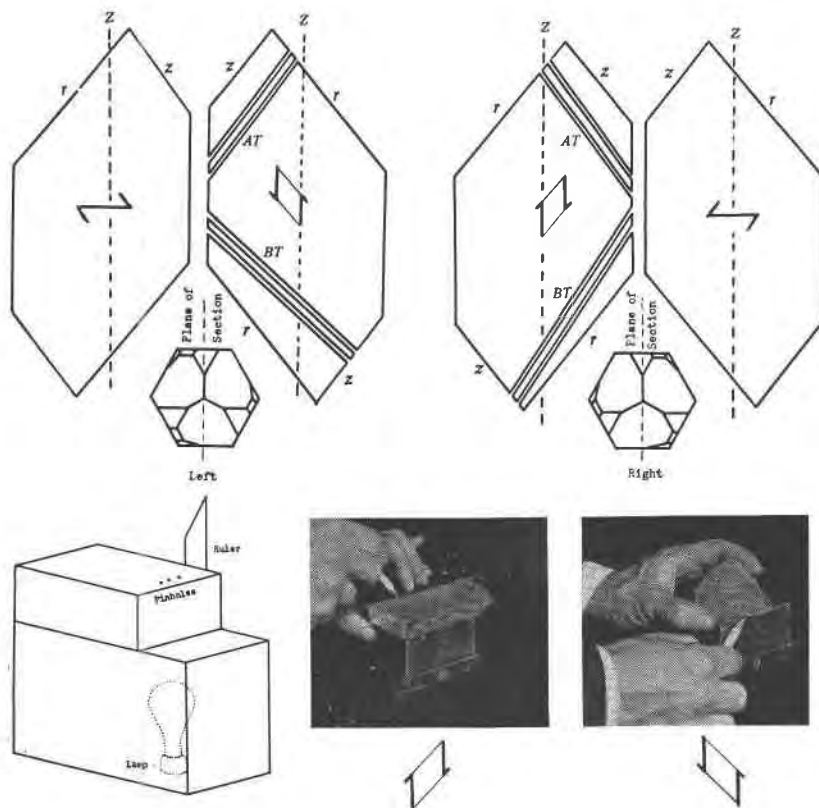

FIG. 17. Orientation with parallelogram light figure. The four possible light figures on X-sections are shown above. The rule is to turn to the side showing the parallelogram and rule a line parallel to Z (the short side of the parallelogram) on the top side if *r* slopes NE-SW, or on the under side if *r* slopes NW-SE. The ruled side is mounted down so that in all X-blocks *r* slopes NW-SE, thus simplifying saw table settings and correlations with *x*-ray goniometer readings.

ary for cutting apart and processing each part separately. To avoid processing of those parts which will give no yield, badly twinned and flawed areas may be marked out (Fig. 14).

9. *Orientation of Etched X-Block.* The etched X-block is placed on a pin-hole light box with the face showing the parallelogram light figure up. The crystal is rotated in the horizontal plane until the optic axis direction, the short side of the parallelogram, is schematically north-south. If the long side of the parallelogram, the major rhombohedron direction, slopes NE-SW, a line parallel to the optic axis is ruled on the top side of the X-block. If the long side slopes NW-SE, a line parallel to the optic axis is ruled on the under side of the X-block (Fig. 17).

10. *Mounting X-Block.* Same as step 3: ruled face must be in contact with glass.

11. *Orientation of X-Block on Saw Table.* The procedure outlined in steps 9 and 10 assures that the major rhombohedron of all X-blocks will slope in the same direction when mounted, regardless of the hand of the crystal or the polarity of the X-axis. The orientation of the X-block and correlation of the saw table and x -ray readings is thus simplified and an easily visualized set of rules (Table 2) can be applied for all types of cuts. With the long reference edge of the glass plate locked against the reference edge of the saw table, AT-type cuts are turned counterclockwise to the desired ZZ' angle and BT-type cuts clockwise (Fig. 17).

12. *X-Ray Check of Test Cut Wafer.* A thin test cut is made from one side of the X-block, marked and checked by x -rays using exactly the same procedure as in Steps 3 and 4. The (0111) atomic planes, $2\theta = 26^\circ 40'$ for $\text{CuK}\alpha$ are used for AT-cuts and (2023), $2\theta = 68^\circ 06'$ for BT-cuts. A sawing precision of the order of $\pm 10'$ to $15'$ is required for ZZ' and XX' , the horizontal and vertical angles, respectively, of the saw table. Since the surface of the wafer is inclined to the atomic reference planes, the horizontal and vertical corrections must be read from different points of the x -ray goniometer scale ($XX' 38^\circ 13' - ZZ' 35^\circ 15' = 2^\circ 58'$ apart for AT-cuts and $XX' 49^\circ 44' - ZZ' 49^\circ 20'$ (nominal) = $24'$ apart for BT-cuts). Where large production is required, it is advisable to set up one goniometer to measure ZZ' directly, and the other XX' . The correlation of x -ray readings and saw table orientation for AT- and BT-cuts for horizontal and vertical angles should be made in the manner described in steps 5 and 6 using a vertical arrow pointing up to preserve the direction.

13. *Wafering of X-Block.* When a perfectly aligned wafer is evinced by x -rays, the quartz is sliced to wafers of minimum thickness with proper allowance for quartz to be removed by lapping and etching. For 6 to 8 MC BT-crystals (0.0125" to 0.0167" final thickness) using a metal bonded diamond blade, such as the Norton 8" diameter, 0.050" thick, #80 grit-size, L25M concentration, mounted on a $3\frac{1}{2}$ " flange, the wafers may be safely cut 0.045" thick (Fig. 15). Unless the ways of the saw table are accurate, each 3rd or 4th wafer should be checked by x -rays to make certain the cuts are within angular tolerance.

14. *Etching of Wafers.* Wafers are cleaned with a solvent such as carbon tetrachloride, set vertically in slotted trays (Fig. 18) and placed in a warm ($50^\circ\text{C}.$) solution of concentrated ammonium bifluoride for $1\frac{1}{2}$ to $2\frac{1}{2}$ hours. A good etch is required.

15. *Inspection of Etched Wafers.* The wafers are examined with a spotlight or twinoscope for optical and electrical twinning, cracks, etc., and all flawed areas are marked out. The usable portion of electrically twinned wafers may be determined by the use of any one of several techniques: (a) position of the twinned portions with respect to the X-planes reference edges which show how the block was oriented with respect to the parallelogram; (b) by differences in transparency of electrically twinned etched portions (only *one* portion of the electrical twin is usable—the more transparent side is nearly parallel to r and usable in BT-wafers; the more opaque side is nearly parallel to z and usable in AT-wafers); (c) by

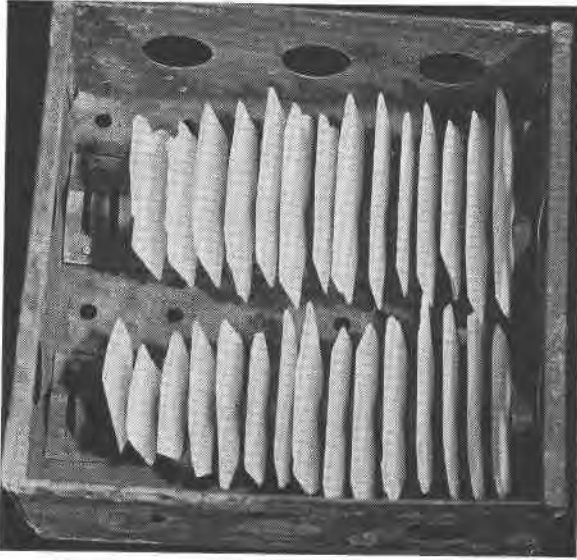

FIG. 18. Wafers are placed in copper trays with notched bases for etching.

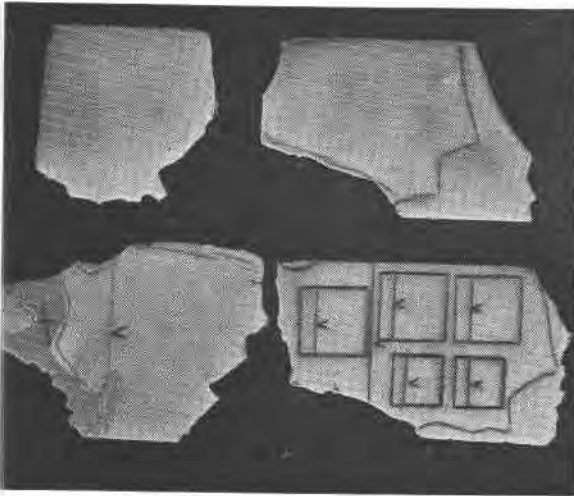

FIG. 19. Procedure for wafers. After etching, the twinned and flawed areas are marked, the usable portion of electrical twins determined, stauroscoped for X and Z, and finally laid out with a rubber stamp. Small blanks are laid out in those areas not large enough to yield the larger blanks.

differences in light reflection; (d) by an x -ray test using atomic planes which have different reflection intensities on opposite sides of the optic axis such as $(01\bar{1}1)$ and $(10\bar{1}1)$ for AT-cuts and $(20\bar{2}3)$ and $(02\bar{2}3)$ for BT-cuts (the side with the weaker reflection is the usable side in both cases); or by a force oscillator and thickness measurement to determine the approximate frequency-thickness constant.

16. *Lay-Out Wafers.* The X and Z directions are determined and marked on each wafer with the angular view stauroscope. X is perpendicular to the two reference edges on the wafer remaining from the X-block stage (Fig. 19). It is therefore only necessary to determine the direction of the optic axis with respect to the plane of the wafer and precision is not required. The unflawed portions of each wafer are then layed out with a rubber stamp (Fig. 20) which is slightly larger (say $0.035''$) than the finished blank and has the X and Z



FIG. 20. Lay-out of wafer with rubber stamp.

directions indicated. It is not necessary to precisely orient the rubber stamp with respect to the reference edges but the X and Z directions determined in the stauroscope are retained.

17. *Trim Sawing of Wafers.* The trim saw is set up with its side reference edge exactly the same distance from the blade as the desired width of the cut blank. By placing the reference edge of the wafer against the back reference edge of the trim saw table, the dicing angle is maintained with respect to the X-axis.

18. *Edging of Blanks.* There are several methods for edging and squaring blanks to final dimensions. They may be loafed together and squared by a machine lap or individually squared with a metal bonded diamond abrasive wheel.¹³

19. *Inspection of Blanks.* All blanks are x -rayed for ZZ' and XX' angles, inspected for squareness and flaws with the aid of a spotlight to insure only perfect blanks being sent to the lapping machines.

¹³ Parrish, William, *op. cit.*

20. *Machine Lapping of Blanks.* The entire high speed lapping to frequency technique is described in an accompanying paper.¹⁴ Three stages using successively finer abrasives, finishing with #303 aluminum oxide are used to bring the blanks within 15 to 30 KC of final frequency. The blanks are then inspected and classified for frequency for final frequency adjustment.

21. *Final Finishing of Blanks.* The blanks are now ready for etching-to-frequency. Usually a two stage etching process is employed: mass etching to within a few KC of final frequency followed by a slow etch to the final point.¹⁵

Coordination of Saws, X-Ray Apparatus and Orientation Devices. It is manifest that absolute coordination of the orientation devices with the saws and x -ray measurements is necessary. It is possible to do this with a few simple rules and without bothering about the hand of the quartz, or the polarity of its axes, or whether x -ray goniometers are used with circles reading clockwise or counterclockwise.

Saws. For precise cutting it is necessary that the saw cuts true; that the plane of the blade is perpendicular to the plane of the saw-table, and that coolants are used that work efficiently and prevent warping of the blade and heating of the quartz. A reference bar is fastened to the saw table, which should be in perfect alignment with the saw blade when the circle reads 0° .

X-Ray Equipment. Standards should be cut from quartz crystals and used to set the goniometer scale to 0° for each atomic plane used.

Mounting Stauroscope. This can be adjusted by means of a piece of Polaroid whose plane of vibration is parallel to an edge. This edge is set against a reference bar on the stage of the instrument. The lower Polaroid is turned to extinction. The test Polaroid is removed, and the analyzer is turned to extinction.

Angular View Stauroscope. The test Polaroid is set against the ruling guide, and the polarizer is brought to extinction, and after the test Polaroid is removed, the analyzer is brought to extinction.

Pin-hole Light Box. The rulers can be set by means of the parallelogram shown by an X-block.

PROCEDURE FOR SMALL DEFACED QUARTZ

A few additional steps are required to process a defaced crystal. Some of the cumbersome methods used in the crystal industry were developed in order to process all raw crystals, faced and defaced, the same way. Al-

¹⁴ Parrish, William, Machine lapping of quartz oscillator-plates: *Am. Mineral.*, this issue.

¹⁵ Frondel, Clifford, Final frequency adjustment of quartz oscillator-plates: *Am. Mineral.*, this issue.

TABLE 2. RULES FOR COORDINATION OF SAWS, X-RAY GONIOMETER AND ORIENTATION DEVICES

MOUNTING. Quartz is mounted on prism or rhombohedron with Z parallel to long reference edge of glass plate, using mounting stauroscope.

PIN HOLE LIGHT FIGURE.

Major Rhomb Slopes NE-SW

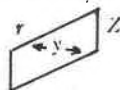

Rule Z on top side
of X-Block

Major Rhomb Slopes NW-SE

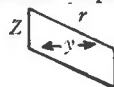

Rule Z on under side
of X-Block

SAW TABLE TURNS

Cut	Direction	Angle from 0°
Z-Plane	C or CC	90°
X-Plane	—	0°
AT	Counterclockwise	35°15'
BT	Clockwise	49°20'

MARKING OF TEST CUTS AT SAW

Mark vertical arrow pointing up \uparrow on outer surface (opposite fresh cut side) of all test cuts.

X-RAY SETTING OF TEST CUTS

Remove burrs and place test cut flush against crystal holder with fresh cut side toward x-ray beam and arrow in view of operator.

Facing Saw, Test Cut from	To measure horizontal angle (ZZ') place arrow	To measure vertical angle (XX'), place arrow
------------------------------	--	---

RIGHT SIDE



LEFT SIDE



Set x-ray goniometer to read *directly* the angular divergence. For example, for ZZ' of an AT-cut, set goniometer scale to 0°0' for desired ZZ' angle for maximum reflection from (011) $2\theta = 26^\circ 26'$. Rules apply to left or right goniometer using C and CC conventions.

CORRECTIONS AT SAW.

X-ray goniometer readings are *duplicated* at the saw. If a reading was *clockwise* from zero at x-ray, saw table is also turned *clockwise*, and vice versa.

ANGULAR-VIEW STAUROSCOPE.

Bring wafer to extinction, then

(1) Draw line left to right (X-direction) —

(2) Mark arrow-head pointing away from observer at far side of blank (Z) \blacktriangleleft

X-RAY MEASUREMENT OF CUT WAFERS AND BLANKS.

For direct readings set x-ray scale to 0° for desired angle and orient as follows,

Cut	ZZ'	XX'
AT	\blacktriangleleft	\blacktriangleleft or \blacktriangleright
BT	\blacktriangleright	\blacktriangleleft or \blacktriangleright

though this is desirable, it is certainly a mistake to handicap a procedure by treating the large majority of the crystals by the more difficult methods required for the small minority of defaced crystals. It is therefore

advisable to take advantage of the natural faces on the crystal and process all faced crystals by the X-block method described above and to set up a special procedure whereby defaced crystals are made into "faced" ones and *then* all crystals can be handled in the same manner.

The cutting of defaced quartz presents no special orientation problems and involves only the cutting of a pair of Z-planes and remounting the crystal for cutting X-planes. The great difficulty in the past has been the mounting of large, quite irregular masses—with curved, slippery and sharp surfaces. Radio engineers have devised elaborate gimbals with tangential screws, and bicycle chains and vises. In one large plant the quartz was pushed around in a conoscope while embedded in modeling clay; it was then circled by a paper mold into which hot wax was poured. The problem was finally solved with the very simple suggestion:¹⁶ "Why not grind a small surface on the crystal so that it could be cemented to a glass plate?" In this process, the optic axis direction is located by means of the conoscope, and the quartz is lifted out and without altering its horizontality is pressed to a rotating lap for a few minutes, sufficient time to grind a surface of about 1" square, suitable for cementing the mass to a glass plate.

A simple jig which allows rocking the crystal in the vertical plane is used only for cutting the Z-planes in order to avoid excessive tilting of the saw table in this operation. This jig based on a design by W. L. Bond and shown in Fig. 21, permits the glass mounted crystal to be locked on the tilting platform whose position can be varied and locked by means of a pair of screws on opposite corners. A track on the under surface fits flush over the track on the bottom of the conoscope tank so that the horizontal correction for Z can be read directly from the conoscope scale. About 40 to 50 defaced crystals can be converted into "faced" crystals, mounted and ready for the X-block procedure by a few people using one saw in a normal working day.¹⁷

1. *Preparation of Mounting Surface.* The defaced crystal is turned in a conoscope until the optic axis is in view. The crystal is lifted out, keeping the optic axis direction horizontal, and pressed on a large rotary lap until a surface large enough for mounting purposes (about 1" sq.) is ground. The crystal is returned to the conoscope, setting its ground surface on the flat surface on the bottom of the tank, and checked to make sure it is within about 10° of parallelism with Z. A line is drawn parallel to Z on the ground surface.

2. *Mounting for Cutting Z-Planes.* Using the mounting stauroscope, the crystal is mounted on a glass plate with Z parallel to the long reference edge.

¹⁶ This suggestion, so reminiscent of Columbus and the egg, was made by Miss Judith Weiss (now at Bryn Mawr College), then engaged in setting up the cutting procedure in the crystal shop of the Philadelphia Signal Depot.

¹⁷ Using the procedure described here, nearly a ton of defaced quartz (over 2200 raw crystals) was prepared by a few people using one Felker #120 saw in less than two months.



(21)

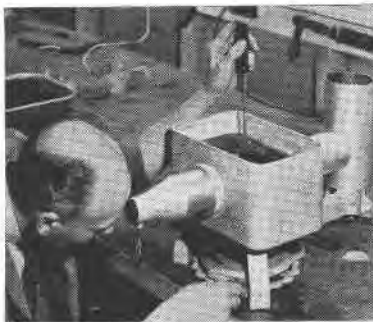

(22)

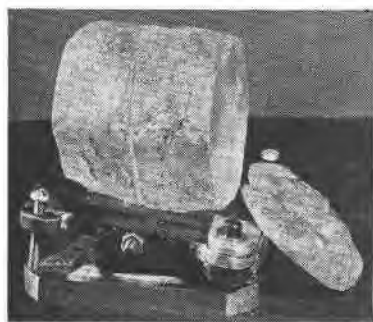

(23)

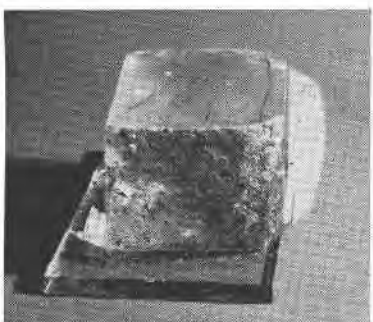

(24)

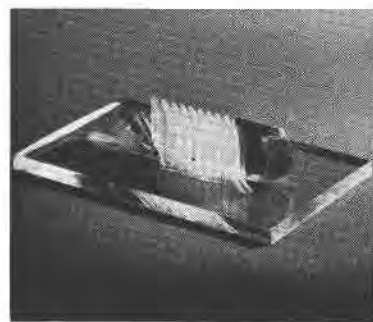

(25)

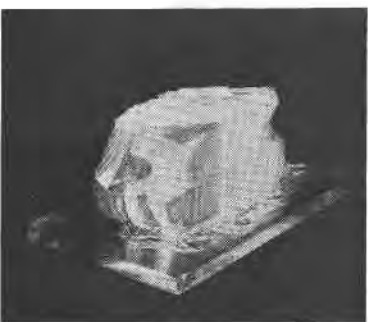

(26)

FIGS. 21-26. Procedures for large and defaced quartz. (21) Defaced quartz mounted on jig in conoscope tank. (22) Adjustment of vertical angle of jig in conoscope. (23) Thick Z-sections cut from large defaced quartz. (24) Thick Z-section cut into an X-block; when remounted it will be ready for wafering. (25) Cutting blanks from a thin Y-bar; flawed portions painted black to avoid useless cutting. (26) Six Y-bars cemented together for wafering. Sides covered with glass to avoid chipping sides. This is nearest successful approach to "gang" cutting yet attempted.

3. *Orientation on Jig.* The mounted crystal is locked on the conoscope jig, placed in the conoscope so that its reference track rides on the track in the conoscope and the screws are adjusted until the optic axis is on the horizontal cross-hairs (Fig. 22). The horizontal deviation from zero and its direction are read on the conoscope circle and marked on the crystal.

4. *Cutting Z-Plane.* The jig is locked on the saw table with its reference edge flush with the reference edge of the saw table, the latter corrected in the horizontal plane as indicated by the conoscope reading, and a test cut is made perpendicular to the optic axis. An arrow pointed upward is marked on the outer surface of the test cut.

5. *X-Ray Measurement of Z-Plane.* The test cut is placed in the x-ray crystal holder with arrow pointing up and measured for horizontal and vertical angle corrections in exactly the same manner described above in the X-block method, step 5. The (0003) atomic planes are used; $2\theta = 50^\circ 40'$ for $\text{CuK}\alpha$. Steps 4 and 5 are repeated until a Z-plane within tolerance ($30'$ to $1''$) is obtained.

6. *Cutting Second Z-Plane.* A second Z-plane is cut on the other side of the crystal and checked by x-rays using the method outlined in step 6 of the X-block procedure.

7. *Etching of Crystal.* The crystal is removed from the glass plate by immersing the mount for an hour in acetone. The crystal is cleaned and etched as described in step 1 of the X-block method.

8. *Orientation of Etched Crystal.* The pin-hole light figure shows three brightest spots forming an equilateral triangle with sides parallel to the Y-axes. A Y-direction is marked on the crystal which will yield the largest X-block.

9. *Mounting for Cutting X-Planes.* The crystal is mounted on a Z-plane with the chosen Y direction parallel to the long reference edge of the glass plate.

The crystal is now ready for processing by the X-block method starting with step 4. The only difference in the two procedures is the optic axis is perpendicular to the glass plate but in the X-block method it is approximately parallel to the glass plate. This, however, causes no change in procedure.

CUTTING SCHEMES FOR LARGE QUARTZ

Single mount direct wafering methods are not feasible for quartz weighing more than 1000 gms. because (a) enormous waste caused by electrical twinning, (b) lack of accuracy in wafering due to excessive blade drift, (c) enormous increase in time required for cutting large wafers. Instead, the practice is to cut the quartz into sections, and then into bars which can be reduced to blanks. The sections are most efficiently and commonly cut perpendicular to the optic axis (Z-sections) because of the ease of locating Z in the conoscope, a choice of three cutting directions for the bars (Y-axis) is available to avoid flawed and twinned areas, and the cut is most likely to be across the shortest section of the crystal thus minimizing errors due to saw drift. The thickness of the sections is determined by the quality of the quartz, size of available diamond blade and size of final blanks. The sectioning methods require three different orientation, inspection, cementing and cutting steps going successively from larger to smaller pieces. The maximum yield and accuracy is obtained in cutting blanks from bars because thinner and smaller blades can be used. Success in cutting large quartz is proportional to the precision with which the first cuts are made and the procedure

should permit checks of cutting accuracy and methods of correcting errors.¹⁸ Large unfaced crystals may be treated preliminarily by the same method described above for mounting and cutting Z-planes. If the crystal is very large it is cut into smaller pieces preferably parallel or perpendicular to Z.

Z-Section, Y-Bar Method. The most efficient method for cutting large quartz of exceptional quality is that of cutting Z-sections about the same thickness as the width of the desired blanks (Fig. 27). The crystal is

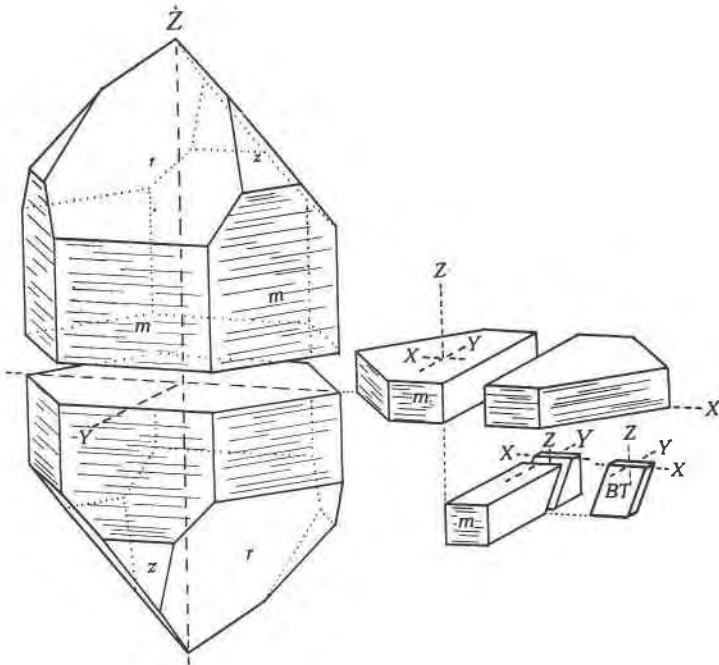

FIG. 27. Thin Z-section, Y-bar method is used for large quartz containing large flawless areas.

mounted on a prism face with thermoplastic cement on a glass plate. If the prism face is excessively inclined to Z the mount may be placed on a jig of the same type as described above for cutting unfaced quartz, or a

¹⁸ In some plants little effort was made to cut the first planes accurately. It was believed that such errors could be corrected later in the procedure. The failure to appreciate the necessity of starting with a precisely oriented plane was inherited from habits acquired in making X-cuts in the earlier days of radio, when a large number of quartz crystals were set in plaster-of-paris in rows and even piled on top of one another to be fed simultaneously into a 24" saw on an adapted milling machine, or were cut up on gang "muck" (loose carborundum) saws.

more nearly parallel face ground on the crystal. The sections may be cut to an accuracy of $\pm 15'$ to $30'$ and checked by x -rays using (0003) planes or with the conoscope. The Z-sections are then etched about 10 hours in concentrated ammonium bifluoride solution at room temperature, inspected and twinned and flawed areas marked out, and the Y-direction identified from the prism faces, by means of the pin-hole light figure, by x -rays or by the thermal parting method. The Y-bars are also cut the same thickness as the width of the desired blanks to an accuracy of $\pm 15'$ to $30'$ using (1120) planes for x -ray checks of test cuts. The bars are etched, oriented by the pin-hole parallelogram light figure, electrical twinned portions marked for cutting apart, twinned and flawed areas painted black to prevent useless sawing, and remounted for final slicing into blanks (Fig. 25). In cases where real precision has been achieved in cutting the bars, a number of them may be cemented together and wafered at the same time (Fig. 26). This is the nearest approach to gang precision cutting that has been attempted with any degree of success, and is done with a single blade.

Thick Z-Section, X-Block Method. When the quartz is not of the best quality, a modification of the above method will give a greater yield. The Z-sections are cut thicker and these are cut parallel to a Y-axis direction into X-blocks (Figs. 23 and 24). The X-blocks are then wafered and blanks can be diced from clean, untwinned areas of the wafers. In quartz of average radio quality, this method is much more flexible than the one described above, for it permits some selectivity in the cutting strategy.

X-Section, Complementary Bar Method. This method is an inheritance from the X-cut crystal procedure. The quartz is mounted on a prism face and sawed into sections parallel to the YZ plane (Fig. 28). Using the parallelogram light figure on an etched X-section, a direction which is the complement of the angle of cut is desired is ruled on the section (in the case of a BT-cut, this would be $90^\circ - 49^\circ$ or $+41^\circ$ to the optic axis). The X-section is then cut up into complementary bars, from which blanks can be sliced at right angles to the elongation of the bars. The disadvantage of this procedure was the difficulty of cutting large X-slabs with accuracy, and it was difficult to check the accuracy of the cut and to true it, which were advantages presented by the Z-section methods.

Complementary BT-Section Method. This method was evolved in one plant to provide sections which could be wafered on a gang saw. A large quartz crystal was oriented successively in a conoscope and by x -rays and a universal transfer jig was used between conoscope, x -ray and saw. Mounted upon a prism face, the crystal was tilted to the cutting angle and complementary BT sections (0.6" thick) were cut at the complement of the BT angle. The complementary BT sections were then slivered

on a gang saw of 5 six-inch blades. Flanges were wide, so that only 0.7" of the blades were available for cutting—a practical limit. The coolant was fed through the shaft of the milling machine, and out through the flanges and spacers between the saw blades.

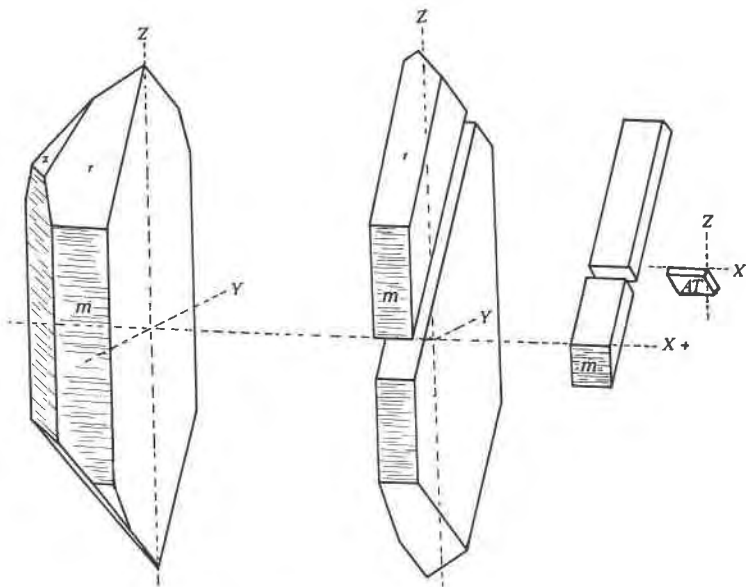

FIG. 28. X-section, complementary bar method.

Complementary Cylinders. A large quartz crystal mounted on a prism face, is tilted to the complementary angle of the cut desired. By means of a tubular drill of the desired diameter, set with diamonds on its cutting edge, cylinders of quartz are cut from the crystal. The cylinders may then be sliced perpendicular to their elongation to yield circular blanks.