

THE AMERICAN MINERALOGIST

JOURNAL OF THE MINERALOGICAL SOCIETY OF AMERICA

Vol. 33

JULY-AUGUST, 1948

Nos. 7 and 8

MULTIPLE DIFFERENTIAL THERMAL ANALYSIS

PAUL F. KERR AND J. L. KULP,
Columbia University, New York, N. Y.

ABSTRACT

In recent years improvements in the equipment used for differential thermal analysis have been developed through work in various laboratories. As a result, the method is finding a constantly broadening application and a number of mineral groups are becoming better understood.

In this article equipment is described which is designed to further increase the utility of the method. Through the use of standard recording devices in circuit with multiple units, six differential thermal curves may be obtained simultaneously. This arrangement makes it possible to secure a large number of determinations in a short time, e.g., eighteen curves in an eight hour day. Both the equipment and a number of applications are described.

THE METHOD

Differential thermal analysis provides a useful technique for the study of specific minerals or mineral groups with distinctive heating curves. The method is suitable for both qualitative and semi-quantitative studies of the clay minerals, the hydrous oxides of iron, aluminum and manganese, the carbonates, the zeolites, and a goodly number of other minerals. In general, the method applies to substances that yield characteristic peaks in the differential thermal curves.

In this technique a dual-terminal thermocouple is employed. One terminal is inserted in an inert material which does not undergo exothermic or endothermic reaction through the temperature interval to be studied. The other is placed in the mineral or mixtures of minerals under test. With a constant heating rate a thermal reaction in the sample will be recorded as a deviation from the straight line plot of temperature difference against temperature. This deviation is dependent upon the nature of the heat change for its direction and amplitude. Peaks may be due to loss of either absorbed or lattice water, decomposition, or changes in crystal structure. They are characteristic for most thermally active minerals. Mixtures show a composite curve of the effects of the individual components in their proper proportion.

Although the original work on thermal analysis was done by Le Chatelier in 1887, it was not until the later 1930's that the method began to be used for semi-quantitative study of clay minerals. In recent years studies have been made at the National Bureau of Standards (Ewell and Insley, 1935), Massachusetts Institute of Technology (Norton, 1939), the United States Geological Survey (Alexander, Faust *et al.*, 1943), the Illinois Geological Survey (Grim and Rowland, 1942), the Bureau of Plant Industry (Hendricks *et al.*, 1946) and various Bureau of Mines research laboratories (Berkelhamer, 1945, Pask and Davies, 1945, and Speil, 1945).

Publications resulting from these studies emphasize the value of differential thermal analysis as a supplementary method coordinated with the chemical, optical, and *x*-ray methods in studying clay minerals. *X*-ray data may have certain advantages in indicating a general clay mineral group. Thermal analysis curves, on the other hand, may contribute quantitative data on mixtures not readily available from *x*-ray diffraction studies. Also, substitution in the clay mineral lattice is frequently more apparent in the peak shifts of thermal curves than in *x*-ray patterns that frequently lack suitable definition. In combination, the two methods offer a solution to many complex problems in the study of clays.

The authors wish to acknowledge the helpful criticisms of the manuscript received from R. E. Grim, Illinois Geological Survey; Ben B. Cox and Duncan McConnell, Gulf Research and Development Laboratories; M. L. Fuller, T. L. Hurst, L. D. Fetterolf and D. G. Brubaker, New Jersey Zinc Company; Robert Rowan, R. H. Sherman, Creole Petroleum Corporation; Parke A. Dickey, Carter Oil Company.

THE APPARATUS

The use of thermal analysis in the study of argillic alteration of a mineralized area, or a stratigraphic correlation problem requires the testing of hundreds of samples. This has involved a tedious laboratory procedure in the forms of apparatus described in the literature (Speil *et al.*, 1945, Norton, 1939, etc.), where a single sample is run at a time. Since each run requires several hours including cooling time, a maximum of about three samples a day may be analyzed. To overcome this difficulty as well as to provide a simultaneous comparative record, a multiple thermal analysis unit was designed (Kulp and Kerr, 1947). The various parts of the equipment were assembled late in November 1946, were placed in operation about January 1, 1947, and approximately 1,500 samples had been run by August 1, 1947.

Figure 1 shows the apparatus as set up in the Mineralogical Laboratory

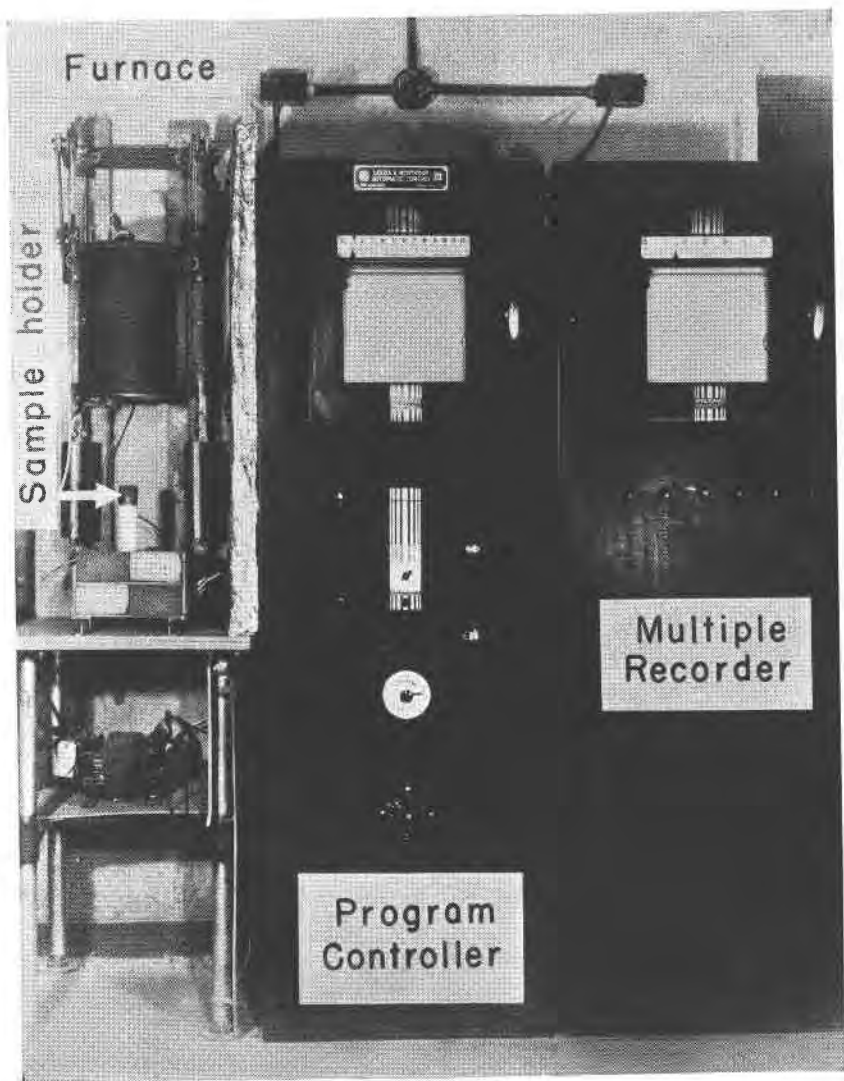

FIG. 1. Complete multiple differential thermal analysis unit.

at Columbia University. For purposes of description, the apparatus may be conveniently divided into four parts: the furnace, the sample holder, the program controller, and the multi-recorder.

The furnace is a Hoskins 305 electrical resistance furnace into which an alundum tube ($1\frac{3}{4}$ " i.d. \times 12" \times $\frac{3}{16}$ " wall) is inserted in order to diffuse the heat and to insulate the metal specimen holder from the heater coils.

The furnace is mounted vertically on a track and can be raised or lowered over the specimen holder by means of counter weights attached to two cables over pulleys.

The specimen holder (Fig. 2) is drilled from a cylindrical block of chrome nickel steel $1\frac{5}{8}$ " outside diameter and 1" height. Both pure nickel and chrome nickel steel have been used but the latter has similar heat conductivity and is less subject to scaling. The six samples to be tested

PLAN VIEW

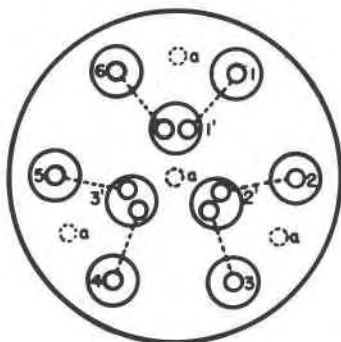

FIG. 2. Nickel specimen holder.

are loaded in the outer holes numbered 1 to 6, while the inner holes 1', 2', 3' are used for inert material which is ordinarily purified alundum, manufactured by the Norton Company. The dashed lines indicate the connections between the two terminals of the chromel-alumel differential thermocouples. Thus one hole containing alundum is sufficient for the inert side of two differential couples. Chromel-alumel couples, B×S 22, were used for maximum e.m.f. generation and were found to be substantial. The dots "a" indicate the positions of the temperature recording thermocouples. The terminals of these couples are adjusted to the same height as the differential couples in the samples. The sample and alundum holes are $\frac{1}{4}$ " diameter and $\frac{3}{8}$ " deep.

The chrome-nickel steel block is supported by an alundum tube ($1\frac{1}{8}$ " i.d. × $6\frac{1}{2}$ " × $\frac{1}{4}$ " wall), and supports a cylindrical cover of solid nickel $\frac{1}{4}$ " thick which is placed on the block to shield the samples from direct radiation. Two complete units of sample holder and thermocouples were prepared. Thus if a break occurs in one thermocouple, the entire unit may be recovered without delay and a replacement connected. The next run may thus be carried out without loss of time for repairs.

The program controller is a special Leeds and Northrup "micromax" which is connected to one of the four possible temperature recording

thermocouples by way of a rotary selector switch. This unit is rated to raise or lower the temperature of the sample at any desired rate from 0 to 50° C. per minute. It will also automatically hold the sample at any desired temperature when that temperature is reached. The pen record indicates the temperature of the sample. The controller, when properly adjusted, gives a linear heating curve.

The recorder for the differential thermocouples is a Leeds and Northrup "speedomax," six point, high speed, high sensitivity electronic recorder with a maximum range of 3 millivolts. The chart of this recorder is synchronized with the chart containing the temperature record on the program controller. This recorder is sensitive to 0.1° C. differential temperature which, with the present specimen holder, gives a peak one centimeter in amplitude for the alpha-beta quartz change. Experimentation on increasing sensitivity with accessory devices is in progress. However, it should be pointed out that beyond a certain limit of sensitivity, thermal gradients, geometry, thermal couple defects, and other unknown factors cause prohibitive irregularities in the base line. The present equipment yields curves that are reproducible to a degree or so in peak temperature and to five per cent of the peak amplitude under normal conditions.

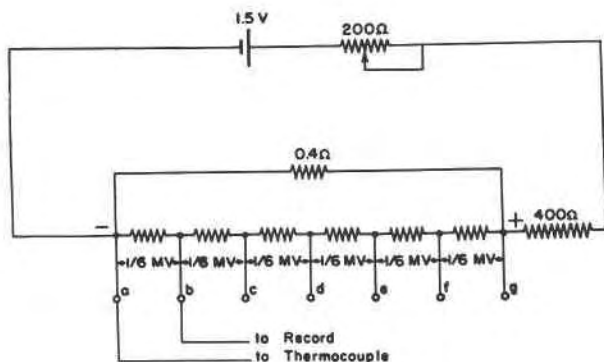

FIG. 3. Potentiometer circuit for spreading records. The unit is placed in series with one head of each thermocouple. The desired position for each couple is achieved by connecting across appropriate terminals from "a" to "g." In the diagram, connection on "a" and "b" would add a constant $\frac{1}{6}$ mv to the base line of the differential thermal curve.

Since all the differential thermocouples print at zero millivolts where there is no reaction taking place, it is desirable to spread the six records. This is done by a simple potentiometer circuit (Fig. 3) which places the base line of each record about one-sixth of a millivolt from its nearest neighbors. The exact separation desired is achieved by adjusting a 200 ohm resistance in the battery circuit. Also it is desirable to have certain

sensitivity scales available since some of the reaction minerals: alunite, jarosite, kaolinite, carbonates, etc., may extend beyond the chart on high sensitivity. Since this type of recorder measures the e.m.f. of the thermocouple, a simple voltage divider with proportionate resistances is efficient for obtaining one-half, one-third, or any other predetermined fraction of the generated e.m.f.

Finally, there are two solenoid pens in series, one attached to the edge of each recorder. By means of a button switch, the solenoids are simultaneously activated, thus marking both records at the same time. Since the temperature at that instant can be read from the program controller record, the temperature of the six records is also known and can be written on the multi-record chart at the completion of the run.

The advantages of this equipment are worthy of note. One of the greatest is the multiple record feature, by means of which with three runs eighteen samples may be tested conveniently in an eight hour day. Also significant is the reduction in the number of potential variables in using six samples under the same heating conditions. This is important when runs of quantitative mixtures are compared. The unit is compact, it does not require a darkened room for operation as in the photographic recording methods, and the results are immediately observable. The chief disadvantage lies in the necessity for applying minor corrections to each curve.

PROCEDURE

The samples to be tested by the differential thermal analysis apparatus are passed through a 50 mesh screen and packed to finger tightness around the differential thermocouple. No pretreatment is given for an ordinary run. It has been found by experimentation, as reported by others, that any attempt to attain equilibrium with a specified humidity merely alters the initial absorbed water peaks (100–200 degrees C.) whose amplitudes are usually not used for quantitative analysis. Ordinarily weighing has been found to be unnecessary and reproducible curves may be obtained for the same pure substance with finger-tight packing with a close fitting metal plunger to a constant level. In special cases attention must be given to the problems of particle size, weight, and humidity.

After the samples are loaded, the cover placed on the specimen holder, and the two charts synchronized, the furnace is started. The heating rate has been standardized at 12 degrees per minute since this gives sensitive control, produces adequately sharp peaks, and is close to the heating rate used by a number of other workers in this field. The record is made from 100 to 1050 degrees Centigrade. At the beginning and end of the run the button switch activating the solenoid pens is pushed, thus fixing the

temperature on the multiple differential thermocouple record. When 1050 degrees C. is reached, the furnace is raised from the specimen holder and the samples removed by compressed air while they are still hot. This procedure prevents "caking" which occurs in certain specimens upon cooling.

The temperature thermocouples are calibrated and recalibrated occasionally with the alpha-beta quartz change. It has been found after trying many different thermocouples that the quartz inversion peak occurs on a differential curve within 5° of 579° C. (This is higher than the equilibrium value.) The reproducibility has also been observed with the standard Georgia kaolinite endothermic and exothermic peaks. Since this is consistent with data in the literature and since the change in peak temperature of pure hydrous minerals may easily vary 5° C., more precise calibration has been considered unnecessary. Different sample blocks, thermocouples, and furnace windings produce no change in peak temperature greater than 5° C.

Although the thermocouples are made as similar as possible and adjusted to approximately the same heights in the sample holes, the sensitivity varies slightly. Therefore, after replacement of one specimen holder and the corresponding thermocouples by another, the first run is usually made with standard Georgia kaolinite in all sample holes. This indicates the relative sensitivity of the various thermocouples. It has been found that these relative sensitivities remain essentially constant for the life of the thermocouples unless the height of the thermocouple is changed due to rough handling.

All curves included in this description are based on the same sensitivity for direct comparison. It has been found convenient to plot the differential thermal curve so that an exothermic peak is upward while an endothermic reaction is represented by a deviation downward from the base line curve.

THEORY

The theory of differential thermal analysis has been presented by Speil (1945). The following account, modified and corrected,* is included to aid in introducing the present studies.

Figure 4 compares two methods of dehydrating a clay mineral. The static method produces the equilibrium dehydration curve while the dynamic method gives the differential thermal curve. In the first instance, the sample is held at each successively higher temperature until it has reached equilibrium. In the latter, the sample is heated at a constant rate,

* Error in Speil's derivation pointed out by Dr. D. G. Brubaker, N. J. Zinc Co., Palmerton, Pa.

thus extending the dehydration over a longer temperature range. Since the thermal curve is a differential function, it depends only on those effects that do not occur simultaneously and equally in the specimen and the inert material. Hence, there are only two thermal effects to consider, the differential flow of heat from the block to or from the thermocouple in the center of the sample and the heat of the thermal reaction. The differential thermal curve of Fig. 4 represents an endothermic reaction. Below

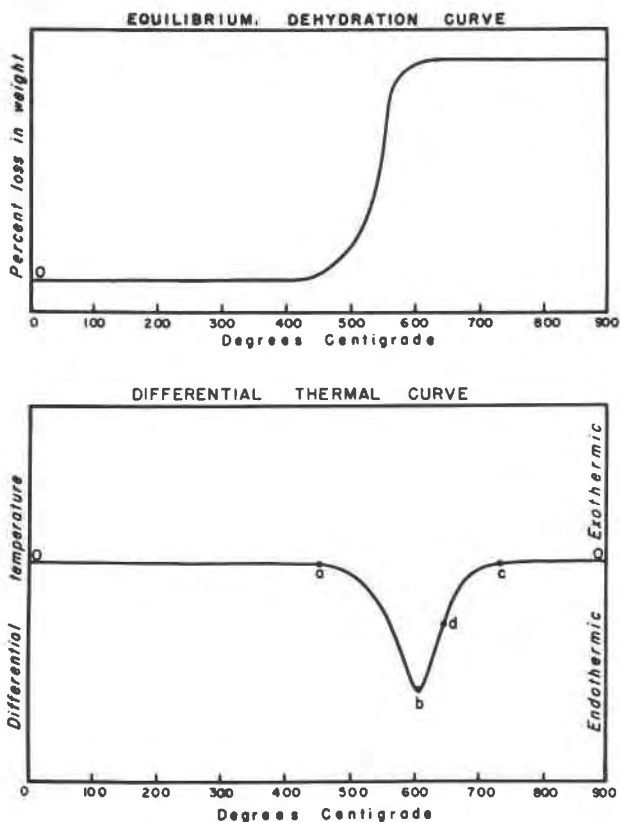

THEORETICAL THERMAL CURVES

FIG. 4. Theoretical thermal curves.

temperature "a," the heat inflow to both thermocouples, sample and inert material, is the same and no difference in temperature is recorded. At "a" the reaction starts absorbing heat from its surroundings making the sample couple cooler than the alundum couple. This effect increases until at "b" the rate of heat absorption by the chemical reaction equals

the rate of differential heat conductivity into the clay specimen. The rate of heat absorption then continues to decrease more rapidly than the inflow of heat from the block. At some point "d" between "b" and "c," the reaction ceases. However, since this point cannot be established exactly, "a" and "c" are usually chosen as limits.

Under static conditions the heat effect would cause a rise in temperature ΔT_s , of a specimen given by:

$$(1) \quad \Delta T_s = \frac{M(\Delta H)}{M_0 C}$$

where M=The mass of reactive mineral,
 H=Specific heat of reaction,
 M₀=Total mass of specimen, and
 C=Mean specific heat of specimen.

However, the heat flow from the nickel block towards the centers of the two sample cavities must be taken into account.

For any point between "a" and "c," the simplified equation describing the changes in heat content of the thermally active constituent is:

$$(2) \quad M \int_a^x \frac{dH}{dt} dt + gk \int_a^x (T_0 - T) dt = M_0 C (T - T_a)$$

(A) (B) (C)

for the inert sample:

$$(3) \quad g \cdot k' \int_a^x (T_0 - T') dt = M_0' C' (T' - T_a')$$

(B)' (C)'

where t=Time,
 M₀=Total mass of test specimen,
 M₀'=Total mass of alundum,
 C=Mean specific heat of test specimen,
 C'=Mean specific heat of alundum,
 k=Conductivity of the specimen,
 k'=Conductivity of the alundum,
 g=Geometrical shape constant,
 T₀=Temperature of the nickel block,
 T_a=Temperature at center of sample at Time T=a,
 T_a'=Temperature at center of alundum at Time T=a,
 T=Temperature at center of sample,
 T'=Temperature at center of alundum

Factor (A) defines the quantity of heat added to or subtracted from the test specimen due to reaction. In an exothermic reaction dH/dt is positive. Factor (B)* defines the quantity of heat absorbed by the specimen. (A)+(B)=(C) because at any point x along the differential

* The temperature gradient in the chrome nickel steel can be neglected as the thermal conductivity of the metal is so much greater than that of the refractory sample to be tested.

thermal curve, the amount of heat used in raising the temperature of the specimen must equal the amount brought in by flow from the metal block plus the amount added or subtracted by the reaction.

In the inert sample factor (A) does not exist, hence the heat which flows in (B)' must equal the heat used in raising the temperature of the specimen (C).'

Letting

$$C' = C + \Delta C$$

and

$$k' = k + \Delta k.$$

Also in the experimental procedure $M_0 = M_0'$ within the error of measurement. Subtracting (3) from (2) and rearranging gives:

$$(4) \quad M \int_a^x \frac{dH}{dt} dt + gk \int_a^x (T' - T) dt - g\Delta K \int_a^x (T_0 - T) dt \\ = M_0 \{ C[(T - T_a) - (T' - T_a')] - \Delta C [T' - T_a'] \} \\ = M_0 \{ D[(T - T') - T_a - T_a'] - \Delta C [T' - T_a'] \}.$$

As $T' - T = T =$ temperature indicated by the differential thermocouple, the equation can be considerably simplified by assuming that the terms containing $(T_0 - T')$, C , and K are small in comparison with other terms. By using "a" and "c" as integration limits:

$$(5) \quad M \int_a^c \frac{dH}{dt} dt + g \cdot k \int_a^c \Delta T dt = M_0 C [(T_c - T_c') - (T_a - T_a')]$$

but to a close approximations*

$$(T_a - T_a') = (T_c - T_c')$$

and

$$M \int_a^c \frac{dH}{dt} dt = M\Delta H,$$

the total heat of reaction

$$(6) \quad \text{so, } \frac{M(\Delta H)}{g \cdot k} = \int_a^c \Delta T dt.$$

The last expression is proportional to the area enclosed by a straight line from "a" to "c," and the curve "abc," if the deviation from the base line is a linear function of the differential temperature. It is proportional, therefore, to the percentage of reacting material in a given weight of sample. This forms the basis for the quantitative use of differential thermal analysis. The linear relationship holds reasonably well. More

* $(T_a - T_a')$ and $(T_c - T_c')$ will equal zero for specimen holders in which the test and aluminum holes are symmetrically spaced relative to the heat source. In the present concentric type of spacing $(T_a - T_a') = (T_c - T_c')$ within the error of measurement.

exact determinations of comparatively simple systems can be made by running known mixtures and preparing a calibration curve of area (vs.) percentage of each component.

The above derivation neglects the differential terms and the temperature gradient in the sample. It shows that the area under the curve is a measure of the total heat effect. The area is also considered independent of the specific heat. This factor, however, actually does affect the shape of the peak and may change the area slightly. For many purposes the approximate relationships are sufficient.

Qualitative Applications

The various clay minerals yield sufficiently different peaks to make the differential thermal analysis method particularly useful. When a specimen is relatively pure, preliminary identification by thermal curves is frequently comparatively simple. In addition, two component mixtures are often resolved and even three component mixtures at times. If, however, mixtures become too complex, only one or possibly two of the major components may be identified.

The multiple thermal analysis apparatus makes possible a rapid widespread survey of the groups of minerals that can be identified by this procedure. The thermal curves given here are representative of the results obtainable. It is believed that they agree substantially with those of the other workers on record. Illustrative curves are shown for the kaolinite and montmorillonite groups along with the hydrous oxides of aluminum and iron, some sulfates and carbonates.

The kaolin minerals, Figs. 5, 6, 7, are characterized by a large endothermic peak ranging from 550° C. to 700° C., due to the decomposition of the kaolinite lattice into amorphous silica and alumina, and a sharp exothermic peak at 980° C. caused by the recrystallization of amorphous alumina to gamma alumina.

Thermal curves of dickite from several localities are shown in Fig. 5. A number of the samples illustrated have been studied in connection with other investigations to such an extent that they may be considered representative of this clay mineral. The sample from Red Mountain, Colorado, was ground and curves were run to compare 100–200 mesh, 200–300 mesh and smaller than 300 mesh material. It is interesting to note that an ordinary specimen from St. Peter's Dome yields a curve similar in character to Red Mountain dickite ground to minus 300 mesh. It is evident that particle size is a factor to be considered.

As the degree of orderliness in the superposition of the kaolin layers decreases from dickite through kaolinite to halloysite, the endothermic peak shifts downward in temperature, indicating less stability of the

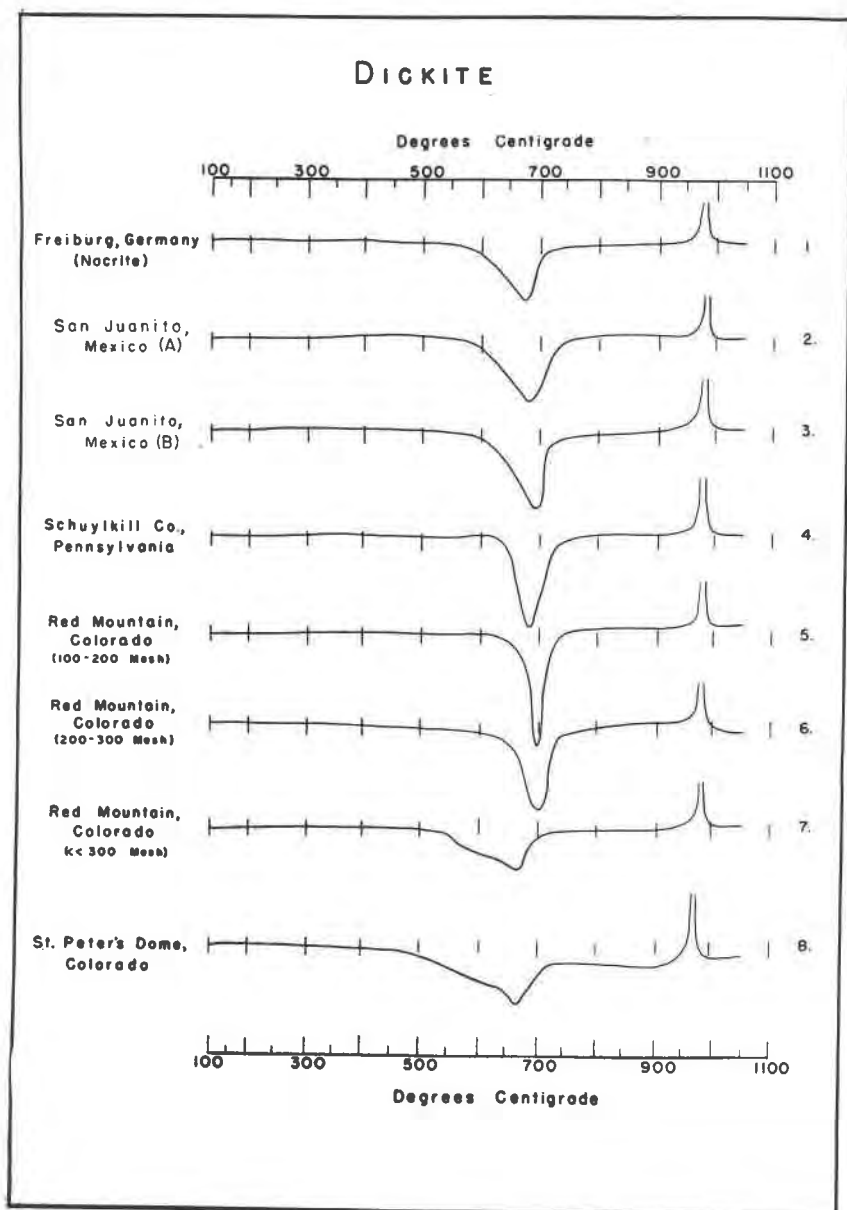

FIG. 5. Thermal curves of dickite from several localities. Curves 5, 6 and 7 indicate the effect of grinding on dickite from Red Mountain, Colorado.

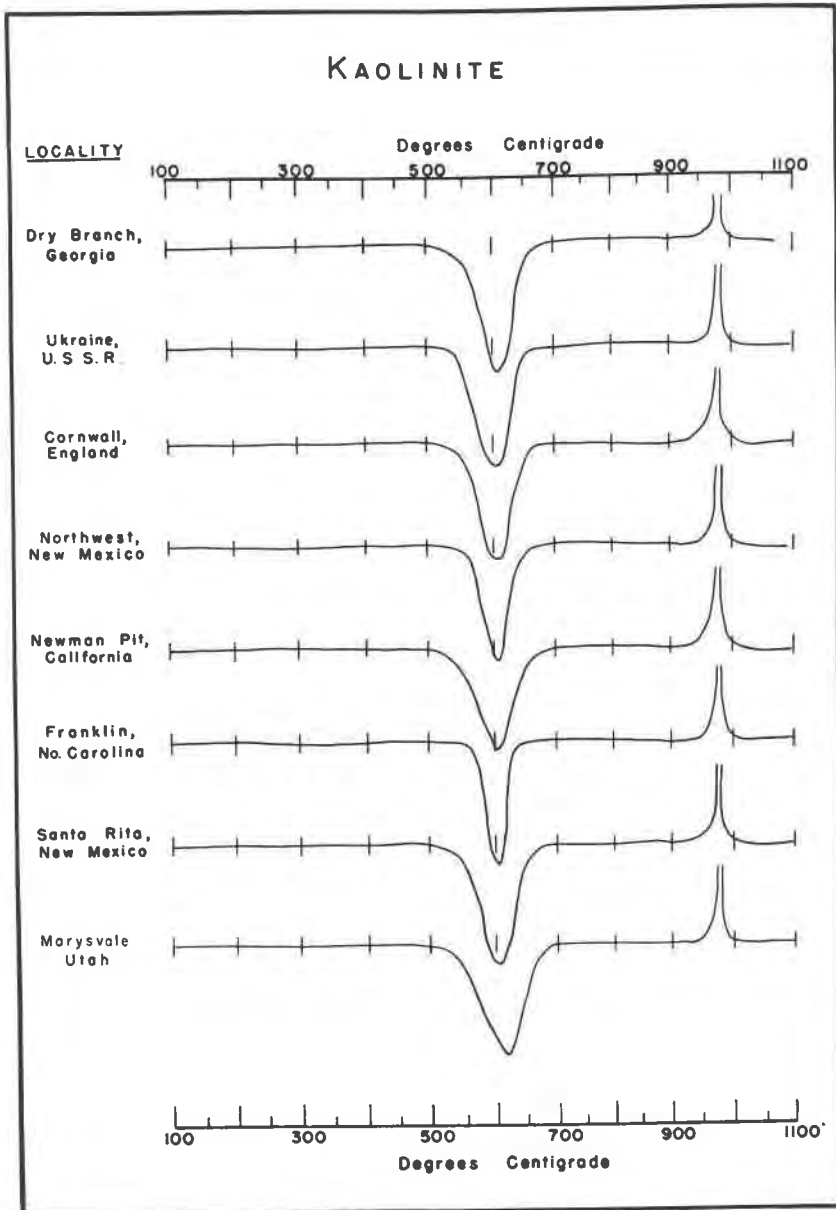

FIG. 6. Thermal curves of 8 specimens of kaolinite from different localities all similar in character.

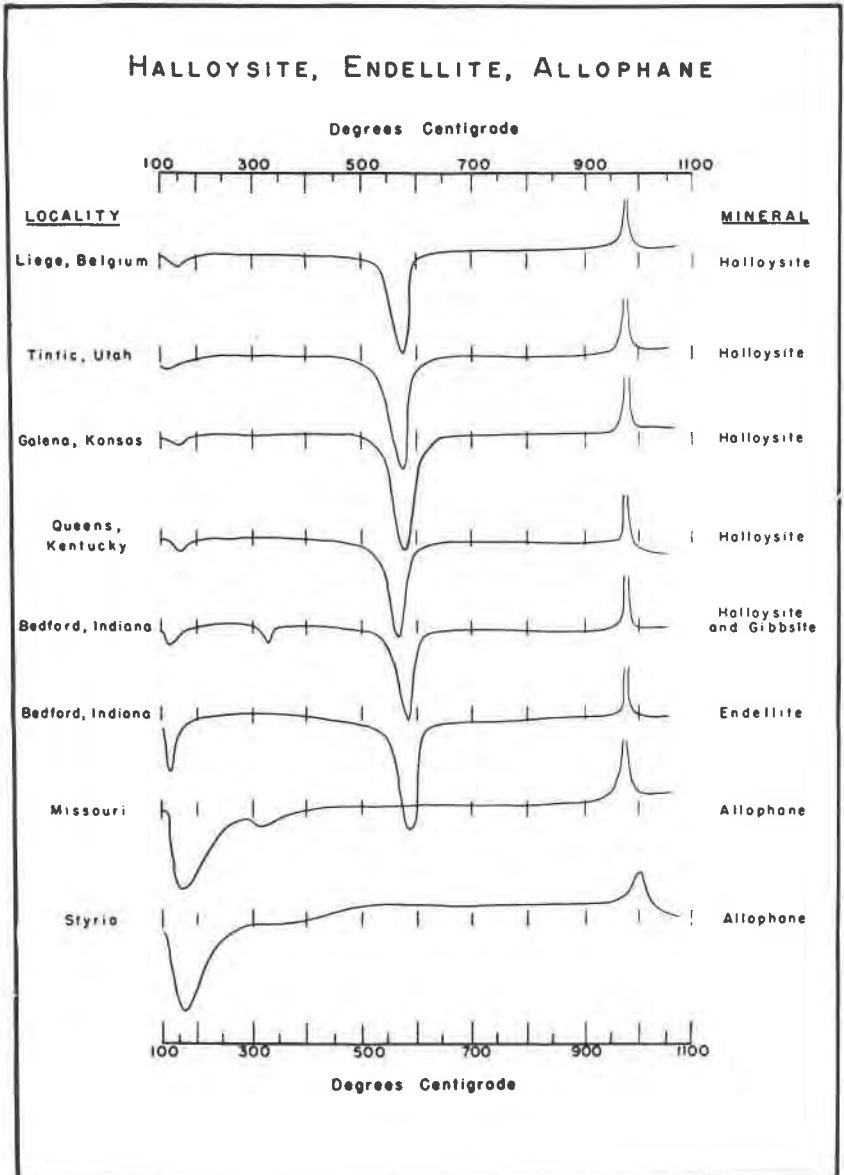

FIG. 7. Thermal curves of halloysite, halloysite mixed with some gibbsite, endellite and allophane.

lattice. The disorder reaches a sufficient extent in the case of halloysite to permit absorption of some water between the lattice layers. This accounts for the minor endothermic peak at about 150° C. This peak is greatly enlarged in the case of endellite, the more hydrous form of halloysite. Endellite yields water to form halloysite under 100° C. Allophane has been considered in the kaolin group (Speil, 1945) presumably because of the sharp 980° C. exothermic peak corresponding to the formation of the gamma alumina, and a rough agreement of chemical analyses. The kaolin group is best delimited by the unique lattice type which is observed in nacrite, dickite, kaolinite, and halloysite.

Figure 6 contains a series of kaolinite curves. The variations in the shape of the endothermic peaks are probably due to differences in clay mineral particle size distribution. The samples with a narrow range of particle size appear to give the sharpest peaks. Since the total heat evolved is dependent only on the concentration of reactive molecules present around the thermocouple, the area under the curve should be roughly constant. It is evident from the set of curves that the differences in the shapes of the curves are not great and, hence, the amplitudes are essentially the same. The specimens from Dry Branch, Ga.; Cornwall, England; Newman Pit, California; Franklin, N. C.; and Santa Rita, N. M., give characteristic kaolinite *x*-ray patterns. The Georgia material was used as a standard for comparison.

The samples were prepared by passing the kaolinite through a 50 mesh screen. One specimen (not shown) of Georgia kaolin "fines" obtained by gravity separation exhibits a kaolinite curve with an endothermic peak depressed slightly and lowered in temperature about ten degrees. The 980° C. exothermic peak of this material also shows a slight shift to lower temperatures. This probably is due to the finer particle size material which is in a less stable state with a correspondingly lower temperature of recrystallization.

A private communication from R. E. Grim indicates that some kaolinite samples give curves with upward swings in the thermal record between the large endothermic reaction and the final exothermic reaction. Also these same kaolinite samples give a slight endothermic dip just before the final exothermic peak. Of the limited number of kaolinite curves shown in Fig. 6, only the Marysville, Utah and Northwest, N. M., samples indicate the slight endothermic peak mentioned above.

Figure 7 contains typical thermal curves of halloysite, endellite, and allophane. The first four halloysite samples are believed to be of high purity. *X*-ray diffraction photographs have been obtained from these four specimens and display the lines of halloysite. The thermal curves are similar to those of kaolinite with two significant differences, the small

endothermic peak at 150° C. due to adsorbed water, and the shift in the main endothermic peak to about 570° C. Grim (1942) claims halloysite does not have a lower temperature for the main endothermic peak than kaolinite. Other workers (Speil, Berkelhamer, Pask and Davies, Norton) show evidence of the lower temperature of the halloysite peak. In this laboratory eight typical halloysite specimens yield endothermic peaks at 575° C. \pm 10° C. On the other hand, the kaolinite samples examined show endothermic peaks at 600° C. or above. This difference is well above the limits of experimental error. One possible complication is noted in the case of very fine kaolinite. Here the 605° C. peak is shifted downward toward the halloysite peak. However, the fine kaolinite does not have as low an endothermic peak as does halloysite, the amplitude and the shape of the 600° C. peak is altered, and the 980° C. exothermic peak is shifted down the temperature scale.

These data are not sufficiently conclusive to establish the range of the endothermic peak of kaolinite. The structure variations in halloysite and kaolinite and the correlation with the thermal phenomena require further investigation.

The halloysite from Bedford, Indiana, contains a small amount of gibbsite. The endellite from Bedford is typical, showing the halloysite curve with a greatly increased low temperature endothermic peak. The last two curves in Fig. 7 are typical of allophane.

Figure 8 contains the thermal curves of certain 3-layer lattice minerals. Montmorillonite furnishes a broad classification for a certain crystal structure, but with wide substitution possibilities in the lattice. An excellent paper by Ross and Hendricks (1945) has contributed to the clarification of this group. The thermal curve of the Polkville, Miss., material exhibits the previously recognized low temperature doublet, the two high temperature endothermic peaks and the final high temperature exothermic peak. The amplitude of the doublet is dependent to a large extent on the humidity conditions before thermal analysis. Hendricks *et al.* (1940) pointed out that the shape of these peaks was due to the quantity of adsorbed water and the type of adsorbed cation between the 3-layer units. The high temperature endothermic peaks occur variably between the limits of 550° C. and 1000° C. This is probably to be attributed to substitution within the layer itself. The temperature of the peaks has not as yet been correlated with chemical analysis. This is now being investigated. The high temperature exothermic peak is dependent in part on the substitution of iron for aluminum within the layer. The substitutions in the montmorillonite lattice are perhaps more apparent from the shifts in the thermal curve peaks than the shifts in the lines of the diffuse *x*-ray diffraction patterns.

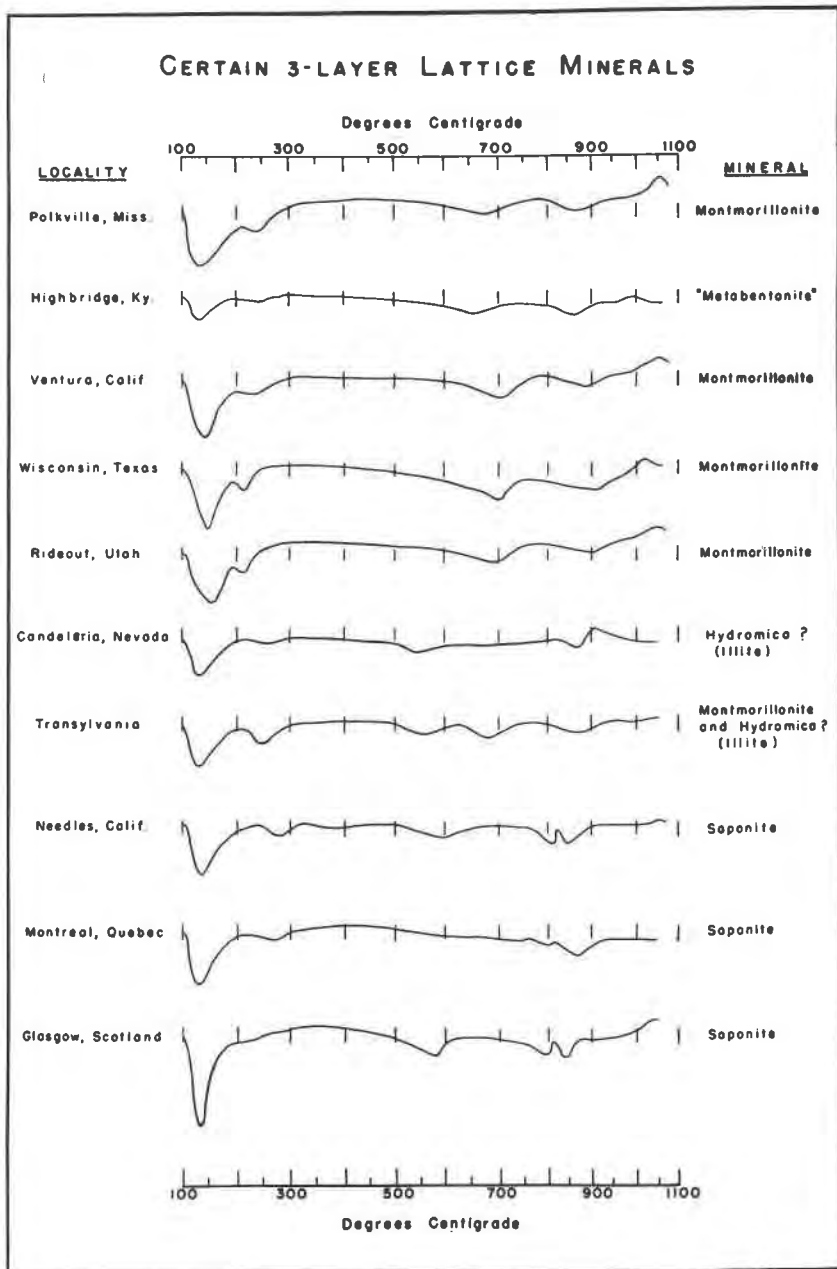

FIG. 8. Several thermal curves of montmorillonite, saponite and examples of hydromica (metabentonite and illite) are illustrated.

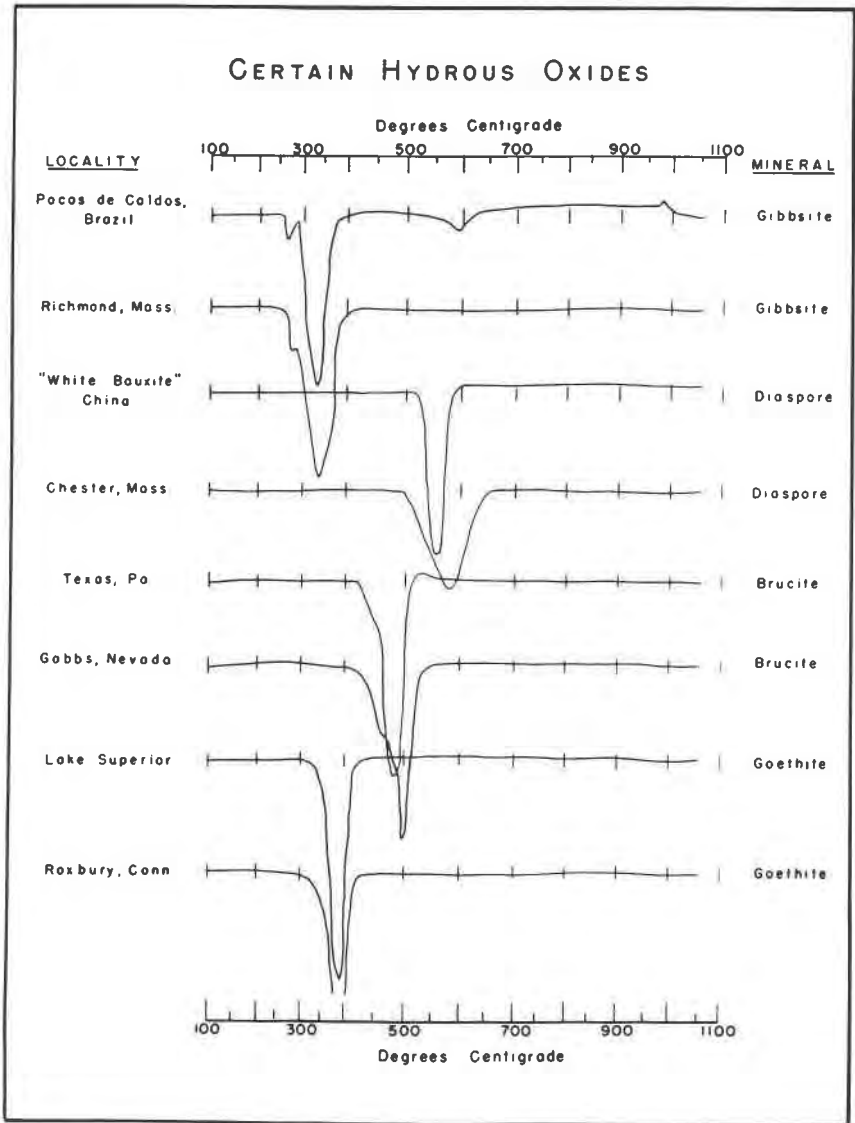

FIG. 9. Curves of gibbsite, diaspore, brucite and goethite are shown for comparison.

The curves of specimens from Ventura, California; Wisconsin, Texas; and Rideout, Utah, are typical of montmorillonite. The "metabentonite" from Highbridge, Ky., contains potash but the thermal curve indicates a material more like montmorillonite than hydromica or illite where the first high temperature endothermic peak occurs at 600° C. or lower. The specimen from Candelaria, Nevada, shows a thermal curve more characteristic of hydromica while that from Transylvania appears to be a mixture of montmorillonite and hydromica (illite).

The last three curves of this set are from specimens labelled "saponite," the high magnesium montmorillonite clay. This mineral shows a distinct double peak in the neighborhood of 800–850° C. All of these specimens give saponite *x*-ray patterns.

Figure 9 shows thermal curves of gibbsite, diaspore, brucite, and goethite. All of these specimens were checked by *x*-ray diffraction. The curves for gibbsite agree with those in the literature which show the main endothermic peak to occur from 330–350° C. Although Speil's (1945) sample does not show the lower temperature minor endothermic peak, the others do. This may be assumed as due to the high purity of Speil's sample. Pask and Davies (1945) ascribe the initial minor endothermic peak to cliachite. The specimen from Poços de Caldos appears to contain a small amount of kaolinite.

The diaspore labelled "white bauxite" from China is apparently unusually uniform in grain size. It powders readily on crushing the sample, making grinding unnecessary. Conversely, the coarsely crystalline diaspore from Chester, Mass., requires considerable grinding. The resulting material evidently has a large grain size distribution as indicated by the shape of the curve. Apparently, both of these specimens are of high purity.

Typical well-crystallized brucite specimens from Texas, Pa., and Gabbs, Nevada, give thermal curves which correspond. Similarly specimens of goethite from the Lake Superior copper district and Roxbury, Conn., agree with each other.

Curves for alunite and jarosite are shown in Fig. 10. These minerals display prominent peaks that are distinctive and can be detected in the presence of foreign materials. The specimens from Bulledehah and Barranca probably contain inert impurities such as sericite which has depressed the peaks. Those from Santa Rita, Hyagoken, Los Lamentos, and Tintic have been checked by means of *x*-rays.

Figure 11 shows some preliminary carbonate curves. These are consistent with themselves and indicate the possible use of thermal analysis for quantitative studies of carbonate rocks. Siderite (Kerr and Kulp, 1947) and rhodochrosite yield exothermic oxidation "domes" due to the

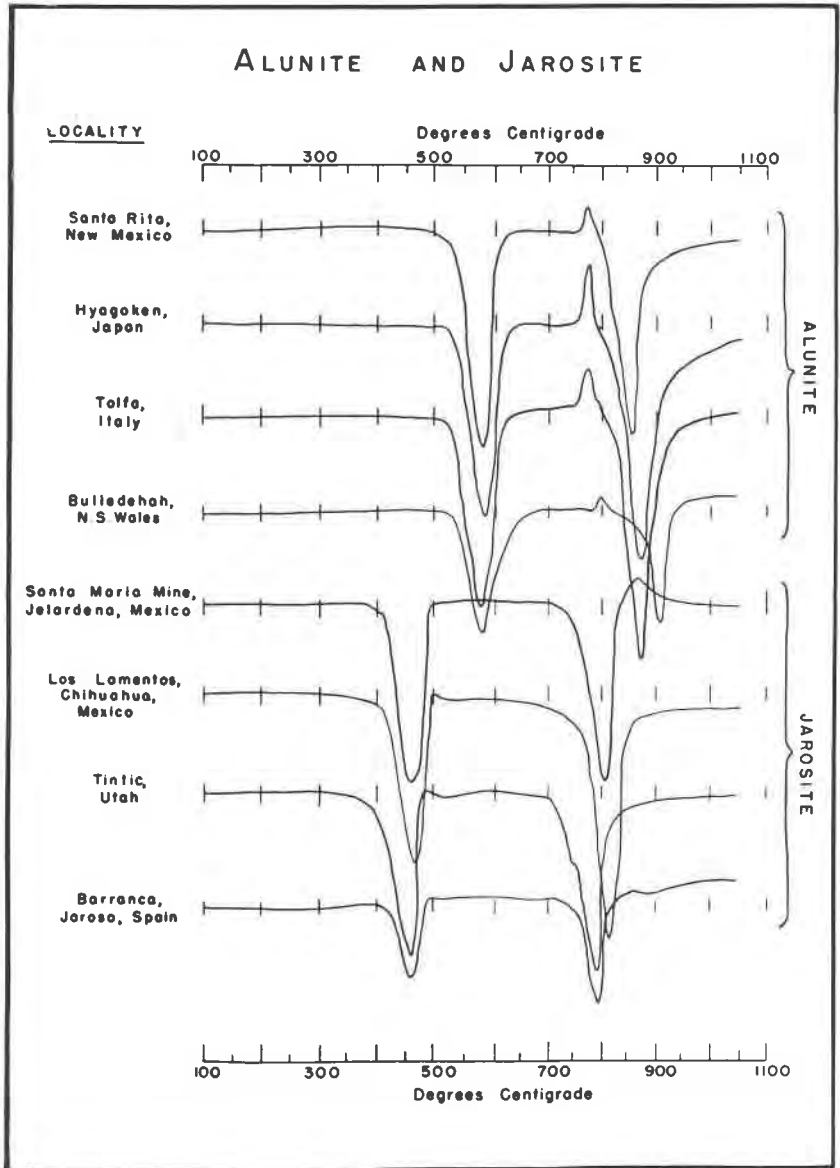

FIG. 10. Thermal curves are shown for alunite and jarosite.

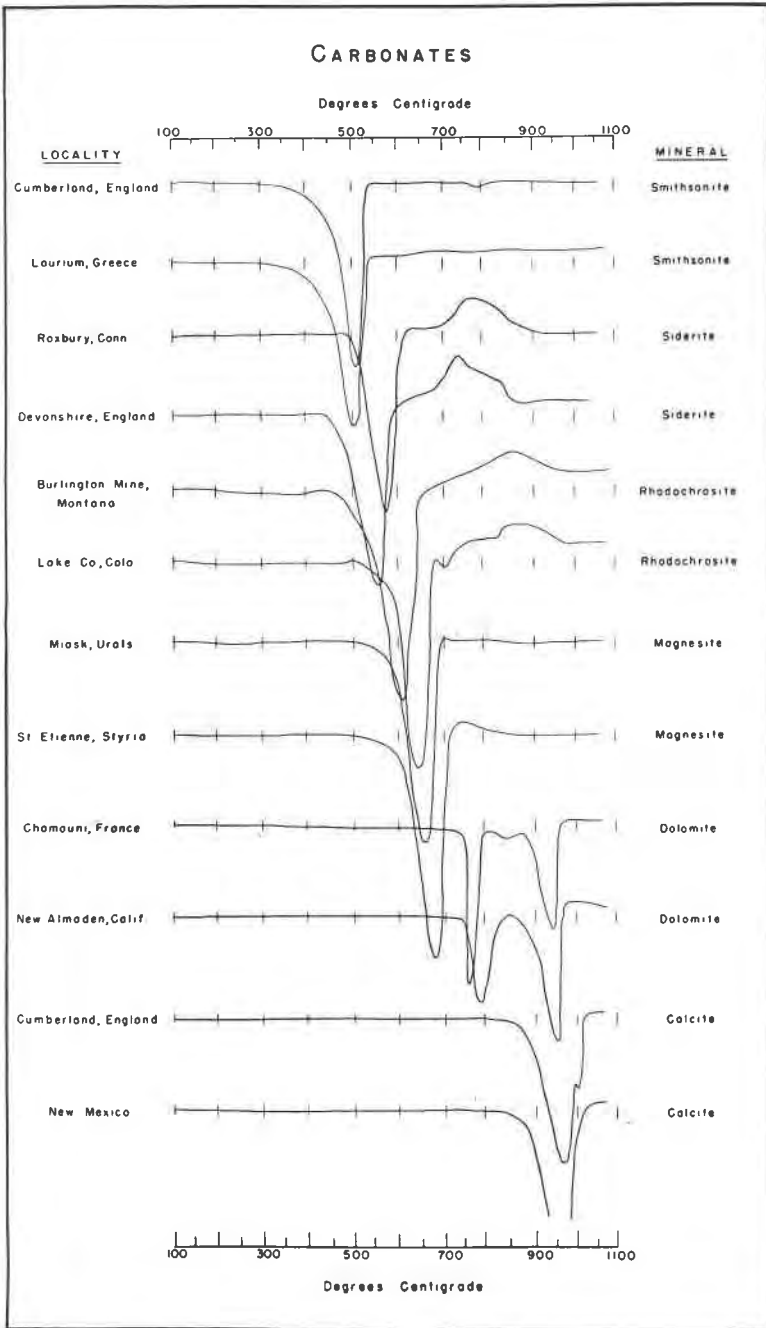

FIG. 11. Thermal curves are shown for a number of common rhombohedral carbonates.

reaction with the oxygen of the air of the lower valence oxide produced in the carbonate decomposition. Cuthbert and Rowland (1947) published thermal curves of several carbonate minerals.

In these curves the carbonate peaks are low due to the admixture of inert material. The curves from Fig. 11 closely approximate the carbonate specimens run by other workers (Speil, Berkelhamer, Pask, Davis, and Faust (unpublished)).

Artificial Mixtures

Figures 12-19 show sets of thermal curves of predetermined mixtures ground to 50 mesh.* Although theoretically the area under the curve should be proportional to the percentage of the mineral present, this does not strictly hold experimentally. It has been found, however, that for known mixtures the amplitude of the peak plotted against the percentage of the mineral present gives a smooth curve. Moreover, it has been found that this "calibration curve" is not particularly affected by the chemical nature of the other components. Using figures for artificial mixtures containing kaolinite to furnish data, the graph, Fig. 20 was prepared. The amplitude of the endothermic 605° C. peak for kaolinite is plotted against the per cent of kaolinite in the particular mixture. A different symbol is used for each mixture. The area within the two smooth curves indicates the possible error to be expected from a mixture of kaolinite with an unknown aggregation, as indicated by artificial mixtures. Clay minerals that give such distinctive peaks as kaolinite may be quantitatively estimated with reasonable certainty for simple mixtures within 10 or 20 per cent. The variation may be due in part to minor differences in the heat conductivity of the foreign constituent.

The necessary assumption to render valid the application of the calibration curve to an unknown mixture is that the clay minerals in the unknown must be in roughly the same physical and chemical condition

* The samples used in these artificial mixtures were essentially uncontaminated materials from well-known localities and were checked both optically and by means of x-ray diffraction. The alunite sample was analyzed chemically by Ledoux and Co.

<i>Mineral</i>	<i>Locality</i>
Alunite	Santa Rita, N. M.
Jarosite	Santa Maria mine, Jelardena, Durango, Mexico.
Kaolinite	Dry Branch, Georgia.
Montmorillonite	Polkville, Miss.
Quartz	_____
Sericite	American Canyon, Nev.
Dickite	Cusihuirachic, Mexico.
Goethite	Lake Superior.

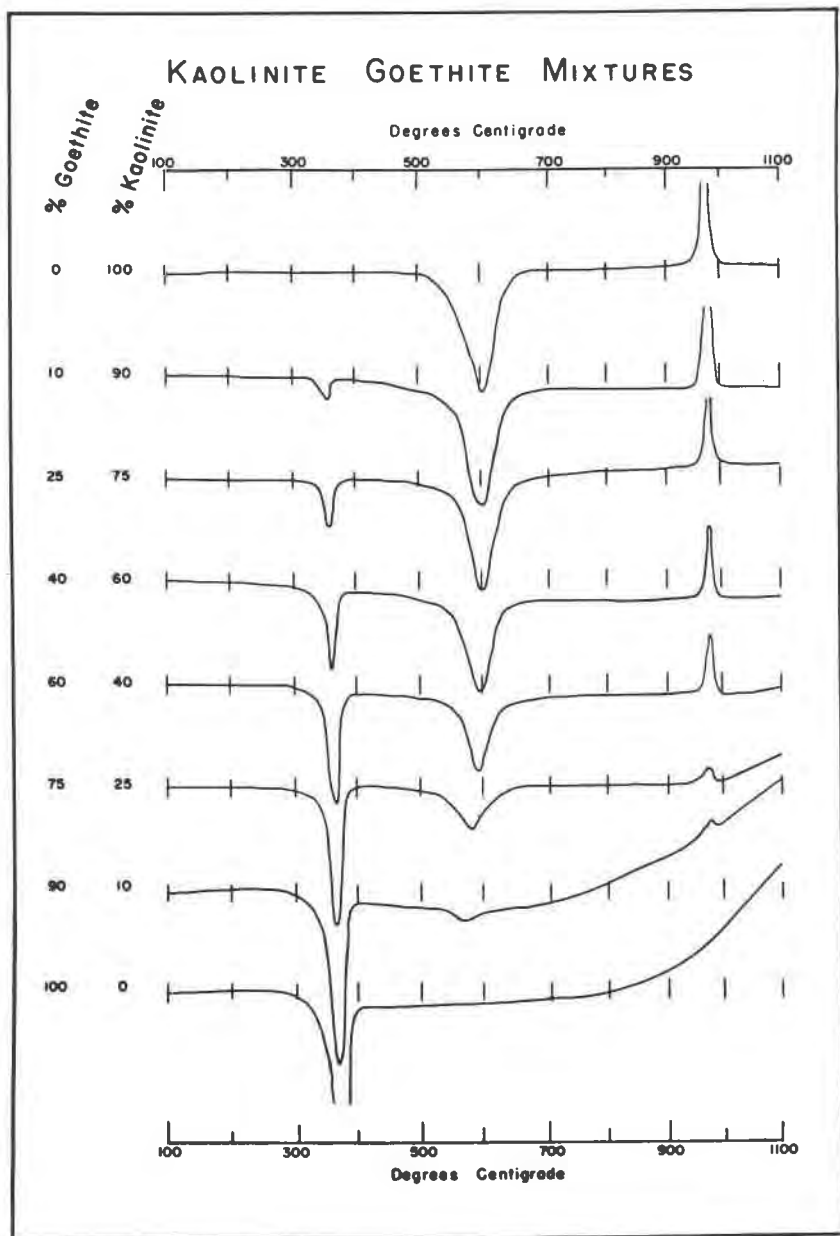

FIG. 12. Artificial mixtures of kaolinite and goethite arranged to illustrate the possible interpretation of natural mixtures.

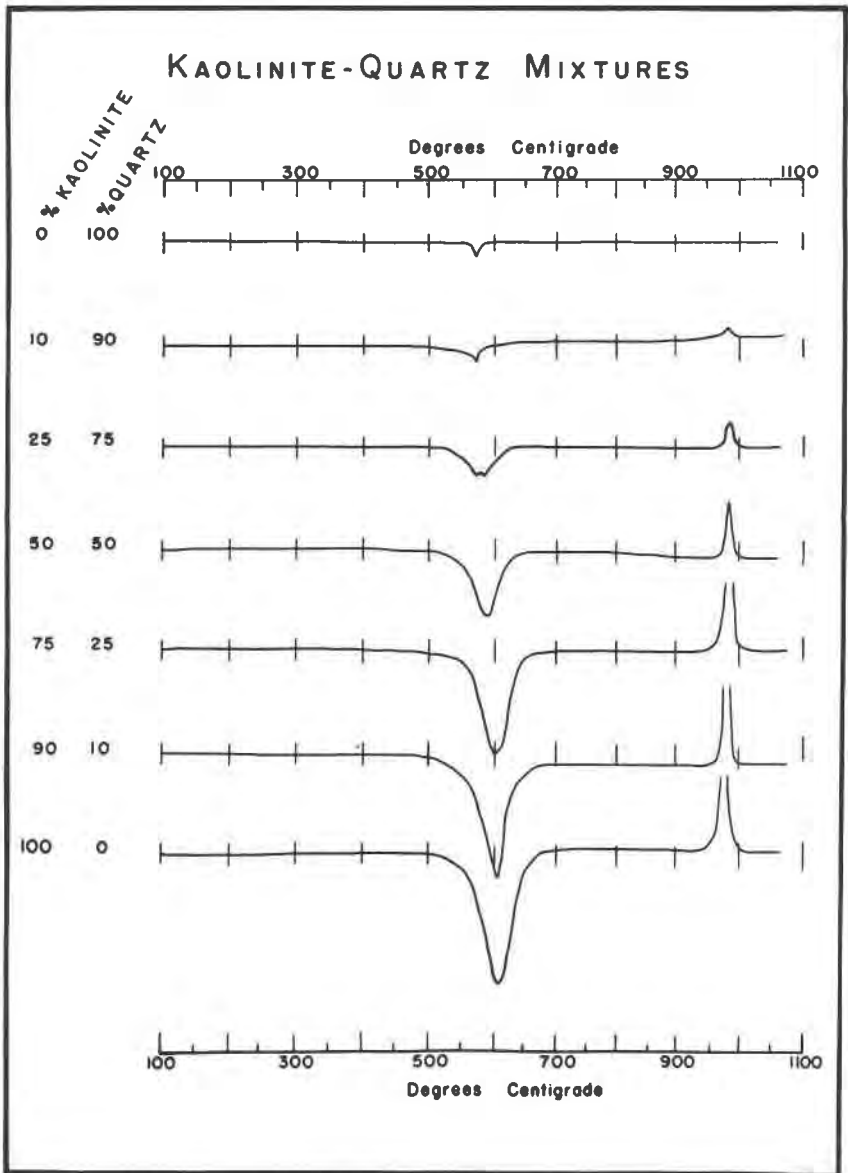

FIG. 13. Curves indicating the effect on kaolinite of quartz as an impurity.

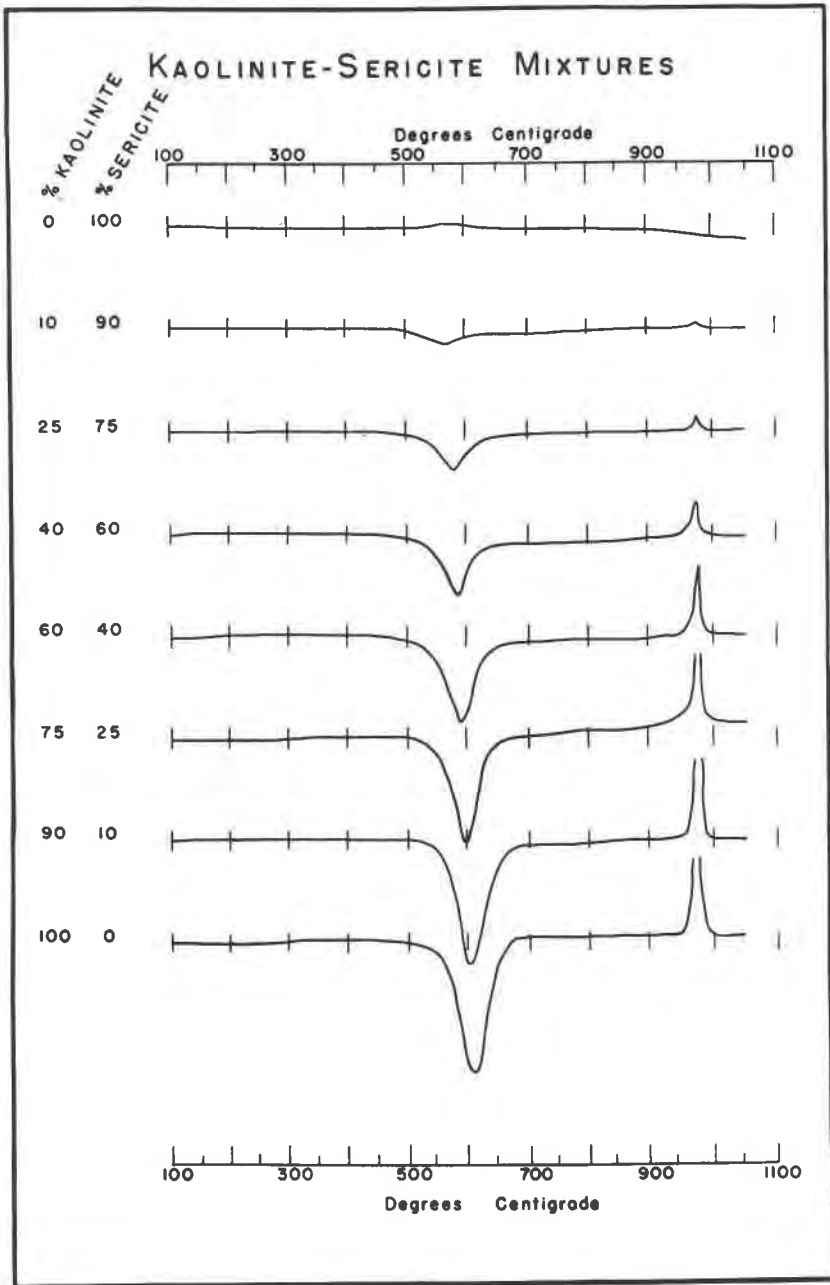

FIG. 14. Curves showing mixtures of almost inert sericite with active kaolinite.

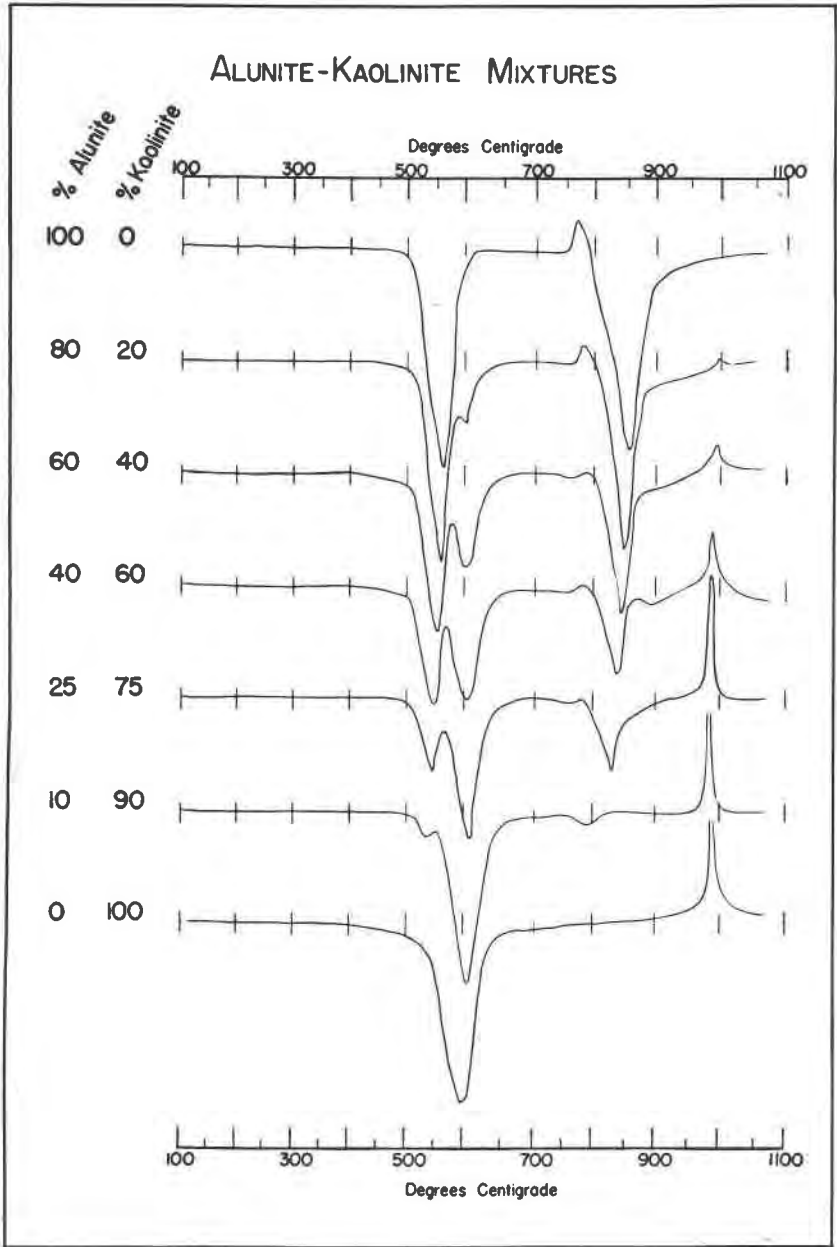

FIG. 15. Thermally active kaolinite and alunite in artificial mixtures.

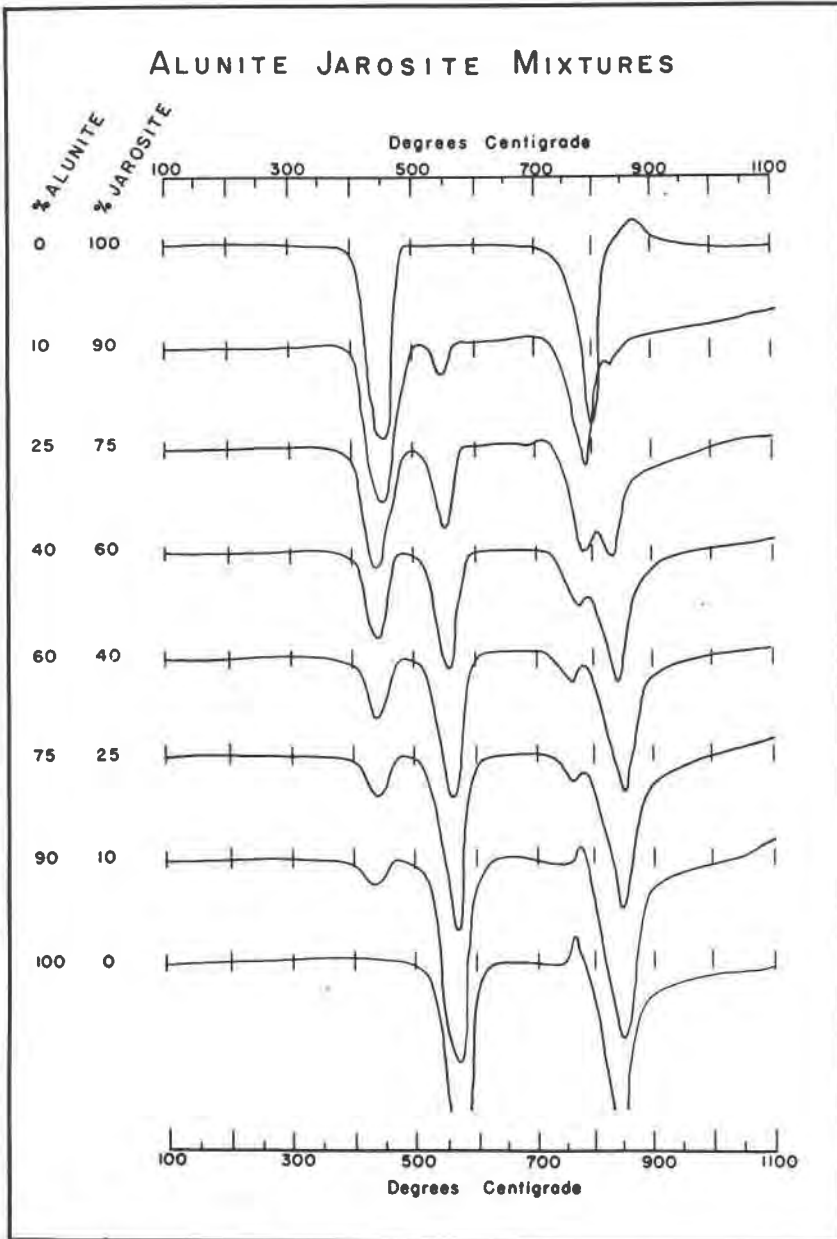

FIG. 16. Thermal curves of artificial kaolinite-jarosite mixtures.

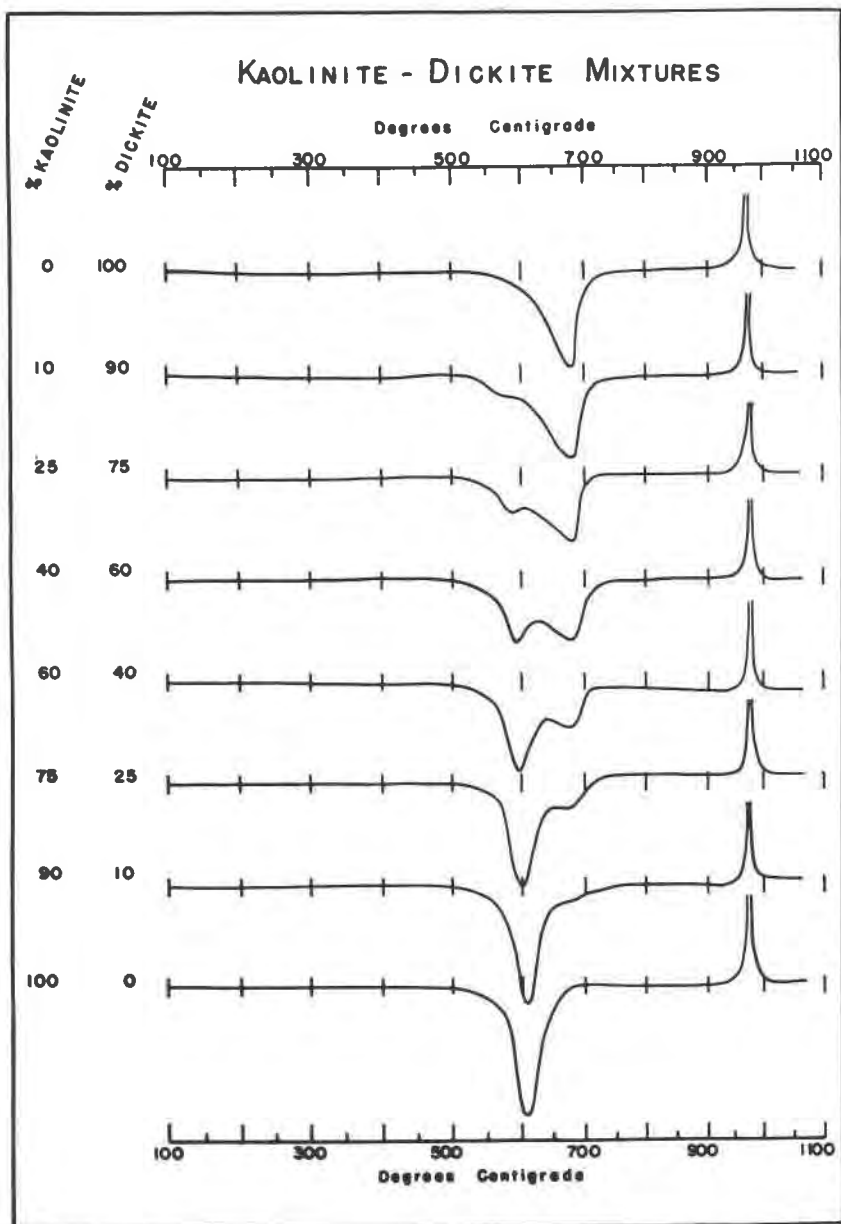

FIG. 17. Artificial mixtures of kaolinite and dickite showing the variation in thermal curves.

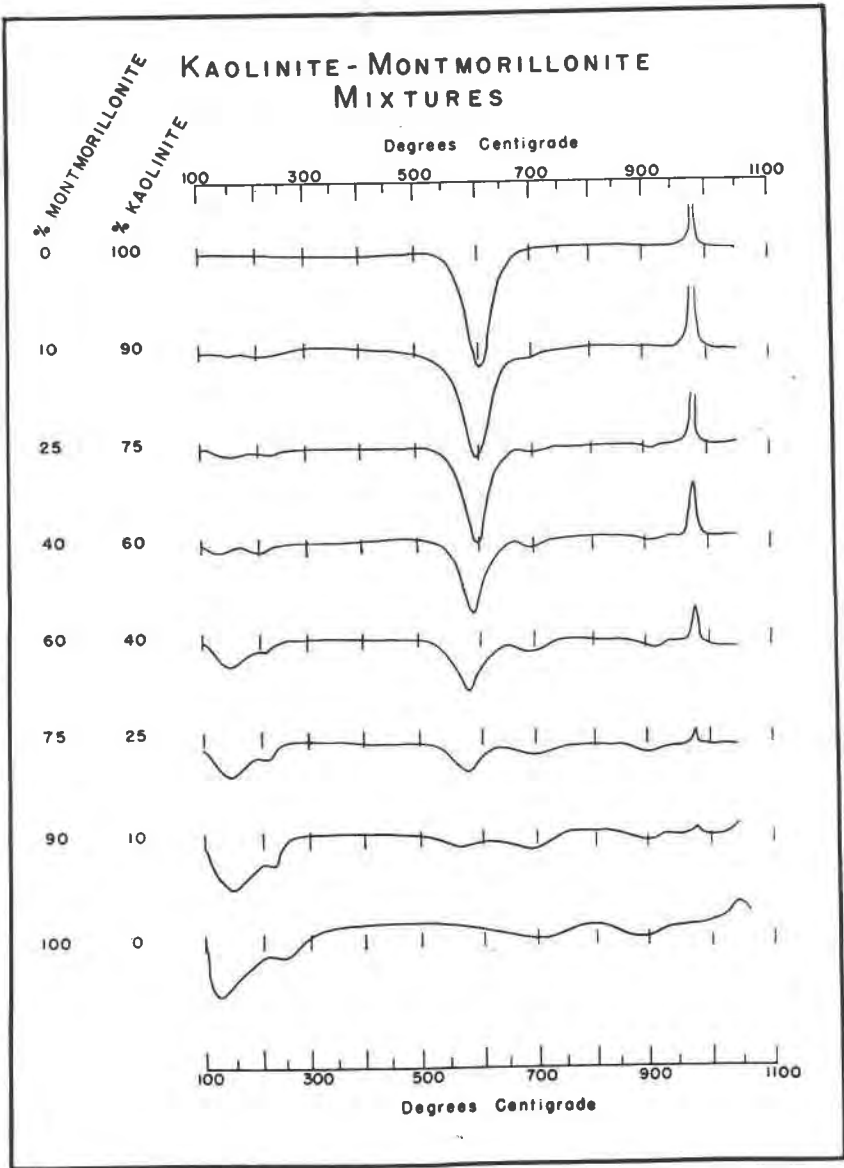

FIG. 18. Thermal curves of artificial kaolinite-montmorillonite mixtures with a range from 0 to 100 per cent.

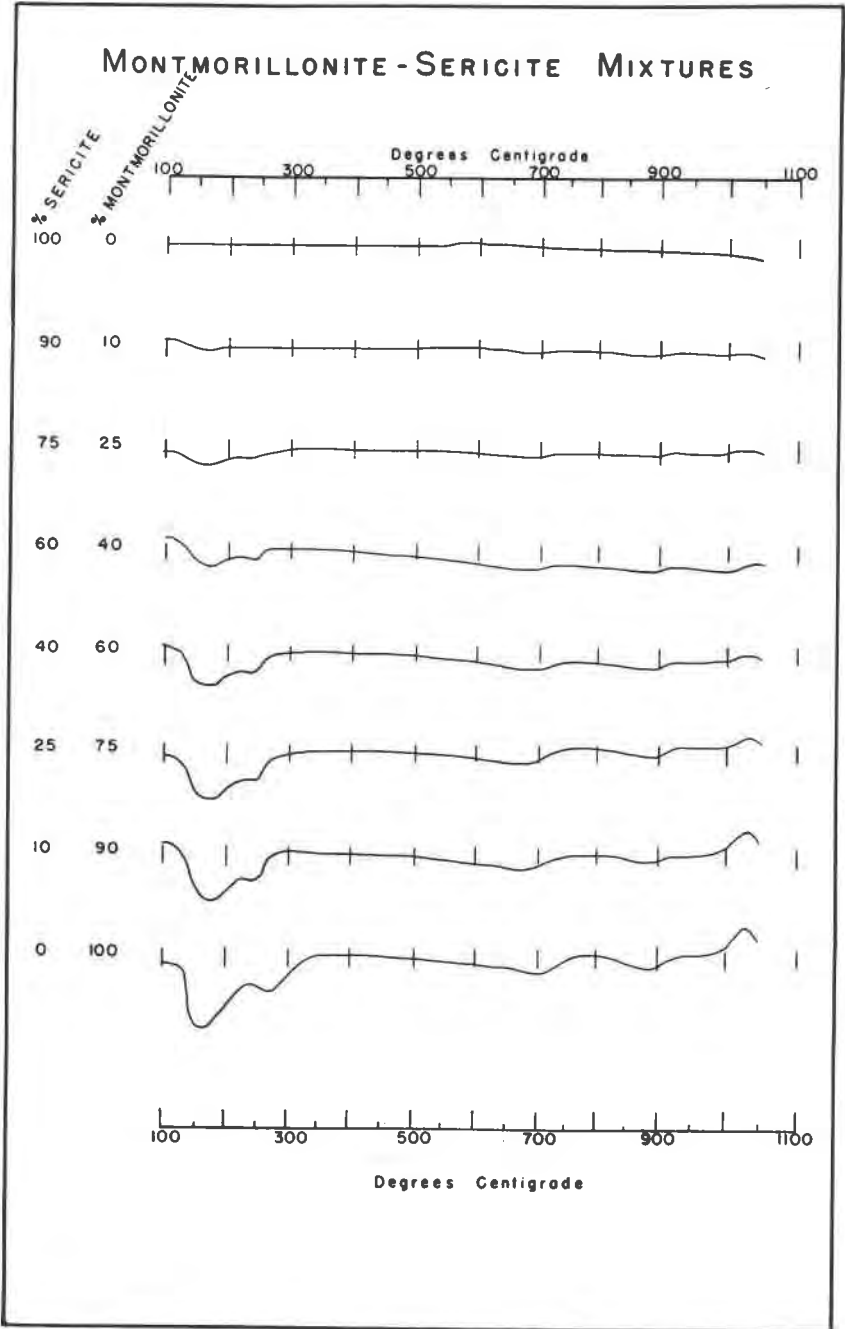

FIG. 19. Artificial mixtures of almost inert sericite with montmorillonite.

as in the artificial mixtures. This is probably a good approximation in many cases, particularly in the case of hydrothermal clays formed in situ. Grim (1947) has already pointed out the need for great caution in making such an assumption for certain sedimentary clay mixtures.

Figure 12 shows a suite of kaolinite-goethite mixtures. The endothermic decomposition peaks for both minerals are shifted down in temperature with increasing percentage of the other mineral. This shift is to be attributed to the conductance of the heat away from the particles in the endothermic reaction by the foreign inert neighbors. The 980° C. exothermic peak is not shifted appreciably. This is probably due to the narrow temperature range of the reaction. Below a certain temperature, under these conditions of molecular structure, amorphous alumina will not change over to gamma alumina. At 980° C., however, crystallization occurs almost instantaneously. Hence, the mixture of 50 mesh inert material with 50 mesh kaolinite does not appreciably shift this peak.

Figure 13 illustrates the effect of mixing quartz with kaolinite. The quartz curve is a straight line aside from a minor peak at the inversion point. The kaolinite curve is depressed by the admixture of quartz, but comparison with Fig. 6 indicates that otherwise there does not appear to be any substantial change.

Figure 14 represents mixtures of sericite and kaolinite. Sericite shows little noticeable differential effect. On the other hand, even as little as 10 per cent kaolinite in a mixture with sericite may be detected. Since both minerals are common in zones of hydrothermal alteration, this feature is of interest.

Figure 15 contains curves of kaolinite and alunite which represent a mixture of two thermally active minerals which may occur together in the same deposits. Both minerals yield sharp and distinctive thermal peaks.

Figure 16 represents a sequence of thermal curves for alunite and jarosite where the samples are artificial mixtures. Both alunite (Fig. 10) and kaolinite (Fig. 6) are illustrated elsewhere. Where curves show such prominent peaks mixtures may be studied with reasonable facility. A proportional decrease in the amplitude as well as a downward shift of peak temperatures occurs with an increase in foreign constituents.

A common problem in the study of zones of argillic alteration concerns the estimation of the relative amounts of kaolinite and dickite present in a natural mixture. Figure 17 illustrates a series of artificial mixtures of the two minerals.

Kaolinite-montmorillonite mixtures are illustrated in Fig. 18. Evidently the apparatus as normally employed is less sensitive for the detection of montmorillonite in a mixture than it is for distinguishing minerals with higher temperature and more distinctive thermal effects.

AMPLITUDE OF KAOLINITE ENDOTHERMIC PEAK IN VARIOUS MIXTURES

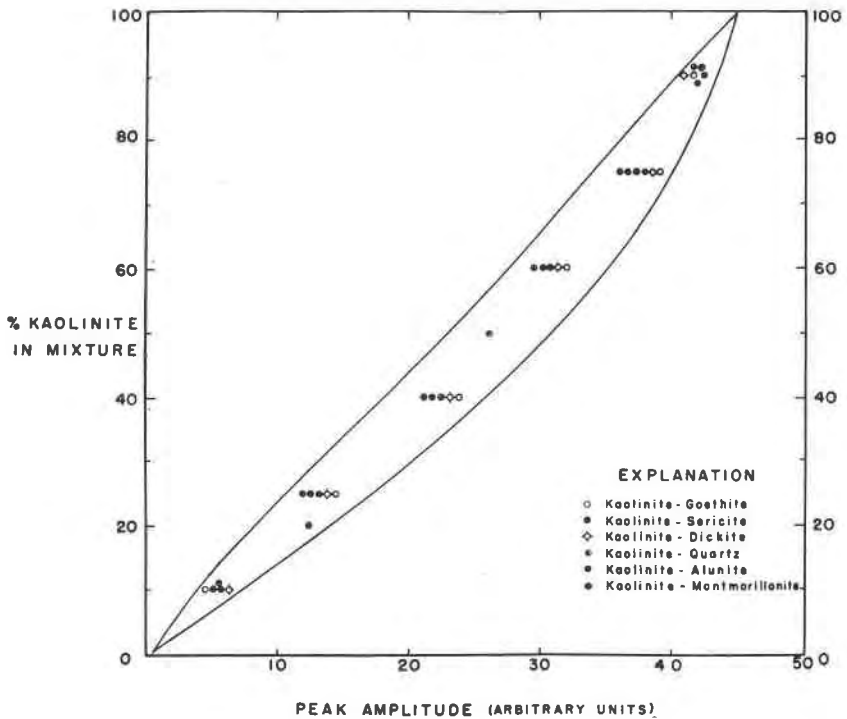

FIG. 20. A graph showing the variation in the position and amplitude of the 605° C. peak of kaolinite in various artificial mixtures.

Montmorillonite-sericite mixtures are indicated in Fig. 19. While montmorillonite would be detected in such mixtures, it seems likely that sericite would escape detection. It is evident that the effect of shifting the peaks with the per cent of impurity must be determined for each mineral to properly identify minerals in mixtures. The carbonates appear particularly sensitive to this effect.

The above curves have been used effectively in the semi-quantitative determination of the argillic constituents of an altered mineralized area. The application of the technique to this form of a problem offers significant possibilities in mapping alteration zones associated with mineral deposits in studies of the type reviewed by Kerr (1947).

The thermal curves thus far obtained in these studies are for the most part consistent with curves recorded in the literature, allowing for the

variation in heating rates. The temperatures at which peaks occur have been agreed upon by various observers with different types of apparatus, providing the heating rates, the thermal couples, and the size of sample are constant. The amplitude of the peaks for any given concentration of active ingredient is a function of the sensitivity of the individual apparatus.

REFERENCES

- ALEXANDER, L. T., *et al.*, (1943), Relationship of the clay minerals halloysite and endellite: *Am. Mineral.*, **28**, 1-18.
- CUTHBERT, F. L., AND ROWLAND, R. A., (1947), Differential thermal analysis of some carbonate minerals: *Am. Mineral.*, **32**, 111.
- GRIM, R. E., AND ROWLAND, R. A., (1942), Differential thermal analysis of clay minerals and other hydrous materials: *Am. Mineral.*, **27**, 746-761; 801-818.
- GRIM, R. E., (1942), Modern concepts of clay minerals: *Jour. Geol.*, **50**, 225-275.
- GRIM, R. E., (1947), Differential thermal curves of prepared mixtures of clay minerals: *Am. Mineral.*, **32**, 493.
- HENDRICKS, S. B., GOLDRICH, S. S., AND NELSON, R. A., (1946), On a portable differential thermal outfit: *Econ. Geol.*, **41**, 41.
- HENDRICKS, S. B., NELSON, R. A., ALEXANDER, L. T., (1940), Hydration mechanism of the clay mineral montmorillonite saturated with various cations: *Am. Chem. Soc. Jour.*, **62**, 1457-1464.
- INSLEY, H., AND EWELL, R. H., (1935), Thermal behavior of kaolin minerals: *Nat. Bureau of Standards Jour. Research*, **14**, 615-627.
- KERR, P. F., (1947), Alteration studies: *Am. Mineral.*, **32**, 158.
- KERR, P. F., AND KULP, J. L., (1947), Differential thermal analysis of siderite: *Am. Mineral.*, **32**, 678.
- KULP, J. L., AND KERR, PAUL F., (1947), Multiple thermal analyses: *Science*, **105**, No. 2729, p. 413.
- LE CHATELIER, H., (1887), The action of heat on clays: *Bull. soc. franc. Min.*, **10**, 204-211.
- NORTON, F. H., (1939), Critical study of the differential thermal method for the identification of the clay minerals: *Jour. Am. Ceram. Soc.*, **22**, 54-63.
- , (1940), Analysis of high-alumina clays by the thermal method: *Jour. Am. Ceram. Soc.*, **23**, 281-282.
- ROSS, C. S., AND HENDRICKS, S. B., (1945), Minerals of the montmorillonite group: *U. S. Geol. Survey, Prof. Paper* 205-B.
- SPEIL, BERKHAMER, PASK, DAVIES, (1945), Differential thermal analysis: *U. S. Bureau of Mines, Technical Paper* 664.