

Synthesis of Barite, Celestite, Anglesite, Witherite, and Strontianite from Aqueous Solutions

CHARLES W. BLOUNT

*Department of Geology, University of Georgia,
Athens, Georgia 30602*

Abstract

Well-formed single crystals of barite, strontium barite, celestite, and anglesite have been synthesized in gram quantities from dilute aqueous solutions in borosilicate glass flasks by a slow precipitation procedure over a range of experimental conditions. The largest crystals were grown in a 0.03 molar HCl solution, near 95°C in a non-uniformly heated flask by combining dilute metal chloride and sodium sulfate solutions at a rate of less than 5 ml/hour. The optimum metal concentrations for growing large crystals were 0.01 molar for barite, 0.02 molar for celestite, and 0.03 molar for anglesite. The optimum Na₂SO₄ solution concentrations were 0.01 molar for barites and 0.02 molar for the other sulfates. Maximum dimensions for the thick tabular single crystals were 0.8 mm for barite, 1.2 mm for celestite, and 2.3 mm for anglesite. In contrast amorphous or submicron-sized precipitates resulted from the use of more concentrated solutions, too rapid a solution combination rate, the use of plastic ware, the use of magnetic stirring, inadequate cleaning of glassware, and uniform heating of the flask.

For the carbonates, witherite and strontianite crystals over 1 mm long were grown in a flask designed to be completely filled with solution. The crystals were grown by combining 0.02 molar metal chloride and sodium bicarbonate solutions at a rate near 5 ml/hr. at 80°C in solutions that were initially 0.001 molar in HCl. Unlike the sulfate minerals, a uniformly heated flask resulted in larger carbonate crystals.

The crystals of sulfate and carbonate minerals had the same indices of refraction as natural minerals. The spacing and intensities of powder diffraction peaks agreed with those published in the Powder Diffraction File for the minerals.

Introduction

Many minerals that exhibit low solubilities in aqueous solutions are difficult to synthesize in the laboratory, especially when coarse, crystalline material is needed. As an alternative, the experimentalist may have to use natural materials that may be impure because of ionic substitutions or small foreign inclusions. In many such experimental studies the presence of these impurities and the chemical effects that they may cause are neglected. In some chemical systems, the effects produced by impurities may be negligible; however, in other systems the effects may be very large. For example, the presence of strontium in barite markedly affects the barium concentration in solutions (Gundlach, Stoppel, and Strübel, 1972). The use of synthetic minerals of known high purity that are chemically and structurally identical to the natural minerals would eliminate the need to correct for coprecipitated impurities or to justify ignoring their presence. There are other advantages also. A radioactive or isotopic tracer could be added when

the mineral is synthesized as an analytical aid. Also, since synthetic crystals have a well developed external morphology, studies of crystal growth, dissolution, and alteration can be made (Blount and Beckman, 1974).

The initial objective of the synthesis studies reported here was to develop a reliable procedure for making gram quantities of pure, coarsely crystalline barite (BaSO₄) for both hydrothermal solubility and phase stability studies. Similarly, procedures were then developed for synthesizing anglesite (PbSO₄), celestite (SrSO₄), witherite (BaCO₃), and strontianite (SrCO₃) from aqueous solutions at conditions similar to those that are believed to have precipitated the natural minerals. Normally, however, precipitates from aqueous solutions in the laboratory are very fine grained, poorly crystalline, and tend to be easily broken. An extensive survey of the literature was therefore undertaken to learn what factors may be important for the synthesis of these minerals.

Large crystals of synthetic barite, celestite, and

anglesite have been produced by a number of procedures. Frequently the experimental synthesis conditions are far different from those under which the natural minerals are believed to have been produced. For example, Patel and Bhat (1972) grew single crystals of SrSO_4 and BaSO_4 up to 1 mm long in silica gels at 20-35°C. These crystals, however, contained large amounts of silica, and their perfection of external form diminished with increasing size. Patel and Koshy (1968a) and Patel and Bhat (1971) developed procedures for growing crystals of SrSO_4 and BaSO_4 from NaCl melts at temperatures between 700 and 900°C that measured up to 7 mm long and 4 mm wide. PbSO_4 crystals of a poorer quality up to 2 mm long were grown in Na_2SO_4 melts in a similar manner. While the (011) and (102) faces were recognized, photographs show the crystals to be quite irregular with a poorly developed morphology. Moreover, the faces of crystals grown by this procedure showed a dendritic pattern which was not observed in any of the samples of natural material. This pattern was believed to have been produced by a rapid precipitation of dissolved metal sulfate that took place when the flux solidified (Patel and Bhat, 1971). X-ray diffraction measurements and hardness tests gave the same results for both natural and melt-grown crystals. The melt-grown crystals also showed fewer dislocations on etched cleavage surfaces than natural materials (Patel and Koshy, 1968a, 1968b).

A large amount of research work has been undertaken in efforts to improve aqueous precipitation procedures that are employed for the determinations of barium and sulfate. The crystals of BaSO_4 that are usually produced by rapid precipitation procedures from aqueous solutions are small, 1-20 microns (Liteanu and Lingner, 1970a, 1970b; Lieser, 1969). Crystals produced in this way are also easily broken yielding much finer material (Nielsen, 1957; Fischer and Rinehammer, 1953). These precipitates are therefore not suitable for many types of experimental studies. Precipitates of SrSO_4 and PbSO_4 have similar properties. Long digestion periods in hot aqueous solutions have been used to recrystallize and coarsen precipitates. Mager and Lieser (1972a,b,c) studied recrystallization rates and the aging of SrSO_4 precipitates and concluded that the effects resultant from aging did not stop even after a very long time. Na_2SO_4 that was occluded during the precipitation continued to be released as recrystallization continued. Aging of

precipitates of Sr, Ba, and Pb sulfates has been used to prepare crystalline material with an average size near 10 microns (Nancollas, 1968). Blount and Dickson (1968) synthesized celestite with the same average grain size, but individual grains ranged from 1 to 120 microns in length. Recently, Brower (1973) used thermal cycling to grow synthetic barite crystals ranging from 50 to 500 microns in length. Barites containing up to 20 mole percent strontium were also synthesized. Up to 2 months of thermal cycling were required in experiments that yielded 5 to 7 milligrams of solid. A considerable amount of finer material appears to be present in the photographs in this paper.

Laitinen (1960) summarized previous studies on the nucleation, growth, properties, and contamination of BaSO_4 and other precipitates used for gravimetric analyses. While aimed at improving analytical procedures, their studies also provided the type of basic data needed for synthesizing highly pure sulfates, as large and dense crystalline grains that resist breakage and display a crystalline structure identical to the corresponding natural minerals. The two most important aspects of these prior studies are the efforts (1) to reduce the number of nucleation sites to promote the formation of a coarser precipitate and (2) to reduce contamination by increasing crystallinity.

The number of nucleation sites can be reduced in a number of ways. Nielsen (1957) found that careful cleaning of glassware using steam generated from distilled water resulted in nearly a 10 fold reduction in the number of crystals formed. Liteanu and Lingner (1970a, 1970b) used a hot alkaline EDTA solution to accomplish the same purpose. Substances that catalyze the nucleation of the precipitate also must be avoided. For example Bricker and Myers (1969) reported that Teflon catalyzed the precipitation of BaSO_4 . Pretreatment of the solutions used for the precipitation is also important. O'Rourke and Johnson (1955) and Bogen and Moyer (1956) both observed that either filtering or aging the BaCl_2 solutions for 24 or more hours reduced the number of crystals 10-fold compared to freshly prepared solutions. They suggested that aggregates of incompletely dissolved BaCl_2 may have served as nuclei for BaSO_4 crystals. The use of dilute solutions is necessary. Liteanu and Lingner (1970a,b) studied the effects of many different experimental conditions on BaSO_4 precipitates obtained using their rapid precipitation procedure.

Depending upon the experimental conditions, the average grain size varied between 1.2 and 6 microns. The largest grains were produced in glassware that had been carefully cleaned and by using dilute solutions (below 0.001 molar) that had been aged, filtered, or boiled prior to use. Meador and Townshend (1966a,b) showed that all solutions contained numerous minute particles (heteronuclei) that provided possible nucleation sites. Attempts to remove these heteronuclei were unsuccessful. Precipitation processes from dilute (0.01 molar) solutions were always heterogeneous. The addition of other dissolved substances to solutions has brought about an increase in the average grain size in rapid precipitations (Fischer and Rhinehammer, 1954). The average grain size of BaSO_4 precipitates increased from 14 microns in water to 135 microns in a 0.005 molar FeCl_3 solution.

Crystal perfection strongly depends upon chemical conditions. Nielson (1958) showed that low concentrations favored surface-controlled growth rates and the formation of orthorhombic crystals. At higher reagent concentrations, diffusionally controlled growth processes became important and star-like crystals were produced. Gordon (1955) recommended homogeneous precipitation procedures using sulfamic acid or similar slow reacting compounds as a source for sulfate because a slow rate of precipitation favored the formation of dense crystals with a minimum coprecipitation of other ions from solution. Fischer and Rhinehammer (1953) also showed that the perfection of BaSO_4 crystals (average size 14 microns) was markedly improved for rapid precipitations when the solutions were aged, dilute (0.016 molar), acidic (pH 0.5-1), and hot (98°C). Crystals grown in cool or in near-neutral solutions were larger (up to 60 microns) but tended to be feathery, irregular, friable, and buoyant.

Espig and Neels (1967) were able to precipitate BaSO_4 , SrSO_4 , and PbSO_4 crystals with good crystalline forms at room temperature from rapidly mixed dilute solutions ranging up to 500 times saturation concentrations. The crystals produced were small: SrSO_4 to 15 microns, BaSO_4 to 30 microns, PbSO_4 to 50 microns. Crystal forms varied depending upon the concentration and composition of solutions. They proposed but did not carry out growing much larger crystals by repeated additions of supersaturated solutions to a solution containing some crystals.

Burkhard (1973) dissolved aqueous precipitates of barium and strontium sulfates in concentrated sulfuric acid and reprecipitated the solid by slowly evaporating the acid at 160°C. $(\text{Ba,Sr})\text{SO}_4$ solid solution crystals over the whole range were prepared including pure barite and celestite. Well-formed individual crystals up to 2 mm long were prepared in this manner. Intermediate composition crystals were smaller and less perfect in form with a barrel-shaped form at 55 percent SrSO_4 .

Experimental

Review of previous studies on the precipitation of BaSO_4 indicated a number of experimental conditions that could be applied in developing a procedure for producing large and dense single crystals of barite of high purity. Six of the experimental conditions that appeared to be most important are listed below.

(1) Clean glassware: All glassware was initially cleaned using a hot chromic-sulfuric acid cleaning solution. After rinsing thoroughly with distilled water, the glassware was cleaned using steam from distilled water following the procedure described by Nielsen (1957) or cleaned using a 0.1 molar EDTA solution as recommended by Liteanu and Lingner (1970a).

(2) Solution homogenization: Experimental solutions were used only after they had aged for several days or were filtered or boiled.

(3) Solution concentrations: Experimental solutions were diluted or made at concentrations between 0.001 and 0.03 molar.

(4) pH: Experimental solutions in the flask were made acidic by the addition of HCl to obtain a concentration between 0.1 and 0.6 molar.

(5) Temperature: The precipitations were carried out at temperatures between 90 and 98°C.

(6) Precipitation rate: The precipitating solution at room temperature was added at a rate between 2 and 5 ml/hr to the hot solution in the flask so that the precipitation was carried out very slowly over a period of many days.

All experimental solutions were prepared using reagent grade chemicals and distilled water. Most solutions were prepared well in advance of the time of their use. The experimental equipment (Fig. 1a) consists of a gravity feed system for adding the precipitating solution, an Erlenmeyer precipitation flask, and a standard hot plate with a variable temperature control. The gravity feed system is com-

posed of a borosilicate glass chromatographic column with a 500 ml reservoir, a precision-type Teflon needle valve to control rate of solution flow, a disposable Pasteur pipet for a drip tip, and several pieces of Tygon tubing to make connections. The Teflon needle valve is positioned to the side to prevent air bubbles that accumulate in the tubing above the drip tip from blocking the valve. The flasks used ranged in volume from 1 to 6 liters. A perforated watch glass reduces the evaporation rate of the solution. The flask is centrally placed on a short (3 cm high) circular aluminum block whose diameter is about 1/3 that of the bottom of the flask. This block promotes convective mixing in the solution.

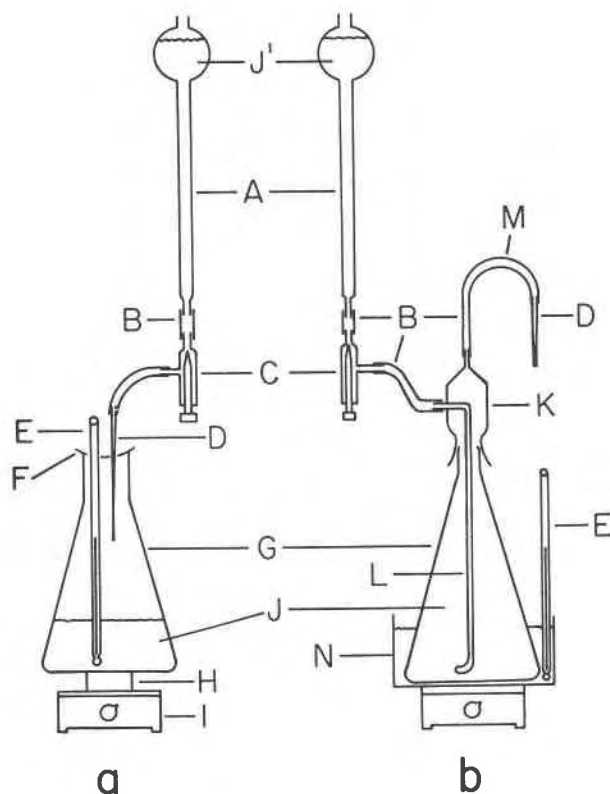

FIG. 1. Experimental apparatus for growing (a) sulfate minerals and (b) carbonate minerals.

Legend: A—Chromatographic column
 B—Tygon tubing connector
 C—Precision valve
 D—Drip tip
 E—Thermometer
 F—Perforated cover glass
 G—Erlenmeyer flask
 H—Aluminum block
 I—Variable control hot plate
 J—Flask solution
 J'—Precipitating solution
 K—Flask closure
 L—Inlet tube
 M—Outlet tube
 N—Silicone oil temperature bath

For a precipitation experiment, the Erlenmeyer flask was partly filled (1/6 to 1/2 of its capacity) with one solution, generally the metal chloride. This solution was acidified, heated to the desired temperature, and the precipitating solution, generally Na_2SO_4 , added. The precipitation was allowed to proceed from several days up to several weeks depending upon the volume of solutions to be combined. The precipitate was separated by filtration while the solution was hot.

Minor difficulty was encountered in maintaining a constant rate of flow for long periods of time with the gravity flow system. Air tended to collect in the tubing below the metering valve. This air was expelled periodically to prevent obstruction of the valve. The valve also required minor adjustment to keep the flow rate as constant as possible. Variations in flow rate below 5 ml/hr did not appear to affect the size and perfection of the precipitate. Additions at a more rapid rate (e.g., 20 ml/hr) resulted in a finer grained precipitate. It was not possible to examine quantitatively the effect of rate of flow on the size of crystals because of the rather poor control obtained from the gravity feed system. A motor-driven infusion pump could be used for such a study and to keep the flow rate constant.

A number of variations in experimental procedures and conditions were examined, but only a few improved the quality and increased the quantity of solid produced. Many had no noticeable effect or else markedly degraded the quality of the precipitate. Eight of these variations are described below.

1. Effect of additional substances: The possibility that other substances in solution could increase the size of crystals (Fischer and Rhinehammer, 1954) was examined by adding ferric chloride to a solution. There was no noticeable change in the size of crystals; however, a reddish precipitate was observed on some of the crystals. While a single experiment is not conclusive, the lack of any change and the contamination of the crystals made this approach unattractive. Precipitation of barite from a 2 molar NaCl solution resulted in the formation of finer grained precipitate.

2. Effect of stirring: Stirring with a Teflon-covered magnetic stirring bar produced an exceedingly fine grained solid. Possibly the Teflon catalyzed the precipitation, or the rotating stirring bar ground the solid. This method of stirring is detrimental. Mechanical stirring of solutions in the precipitating

flask was not studied further because of the successful use of thermal convection described below.

3. Use of plasticware flask: In one experiment a polycarbonate Erlenmeyer flask was substituted for the borosilicate flask. Because of the temperature limit of polycarbonate, this flask was heated in a water bath. The BaSO_4 precipitate produced was extremely fine grained, resembling that obtained during rapid precipitations. Also a carbonate phase composed of long, highly birefringent crystals was evident. Polycarbonate flasks were not used after this result.

4. Use of larger flasks: The initial studies used 1 liter Erlenmeyer flasks, which limited the quantity of barite precipitate to about 1/2 gram. Use of a 6 liter flask produced a better precipitate with the added advantage of a 2 to 3 gram yield of crystals.

5. Thermal convection: Heating the flask on a hot plate creates thermal convection in the flask whereas placing the flask in a silicone oil bath provided more uniform heating and thus suppressed convection mixing. Such suppression produced significantly smaller crystals. In the next experiment, the flask was placed on a small diameter aluminum block in order to increase thermal gradients and convection in the solution in the flask. Fewer crystals were produced and there was a recognizable increase in crystal size and perfection.

6. HCl concentration variation: The concentration of HCl was varied between approximately 0.01 and 0.67 molar. Increasing the acid concentration up to about 0.3 molar seemed to favor the growth of larger crystals. One experiment at 0.67 molar HCl resulted in a finer-grained precipitate.

7. Reversal of solutions: Normally, a Na_2SO_4 solution was added to an acidified metal chloride solution. In a few experiments, the metal chloride solution was added to an acidified Na_2SO_4 solution. There was essentially no significant difference in the precipitates produced by reversing the solutions.

8. Variation in solution concentration: Sulfate minerals were precipitated from metal chloride solutions ranging from 0.001 to 0.1 molar using sodium sulfate solutions ranging from 0.005 to 0.02 molar. Optimum solution concentrations for precipitating large amounts of coarse-grained crystals of barite, celestite, and anglesite could not be sharply defined. Rather these sulfate minerals seem to precipitate over a range of solution concentrations. There is a maximum concentration that may be used for each

sulfate mineral. Precipitates from more concentrated solutions are finer grained and of poorer quality. Maximum (optimal) concentrations are listed in Table 1.

Considerable effort was also spent on attempts to grow barites containing strontium sulfate. In these experiments it was desirable to attempt to maintain a constant solution composition in the precipitation flask. This was done by adding a second solution, that had nearly the same composition as the precipitated barite, at the same rate that the sodium sulfate solution was being added. Here again the gravity feed system presented control difficulties and two 50 ml burettes were used to keep track of solution volumes being added.

Since the solubility of BaSO_4 , increases with increasing temperature up to at least 125°C (Templeton, 1960; Blount, 1971), the possibility that BaSO_4 could be recrystallized in HCl solutions along a decreasing thermal gradient was investigated. Approximately 3 grams of very fine-grained analytical reagent grade BaSO_4 was placed in one end of a 1 inch diameter Pyrex glass test tube that was necked down to 1/2 inch in the middle. The tube was filled to 95 percent of capacity with a 0.6 molar HCl solution and sealed. The end of the tube containing the BaSO_4 was placed in a tubular muffle furnace and heated to 95°C . The cooler end of the tube outside the muffle furnace was near 40°C . After several weeks, small crystals were seen in the cooler portion of the tube. After 6 weeks, the experiment was terminated and the solid examined. The recrystallized solid consisted of well formed single crystals of barite that were up to 0.03 mm long compared to the 0.001 micron size of the original reagent powder.

For comparison purposes attempts were made to

TABLE 1. Experimental Solution Compositions for Producing Large Crystals of Sulfate Minerals*

Precipitate	Concentration Moles/Liter			Crystal Dimensions mm
	HCl	Metal Chloride**	Sodium Sulfate**	
Barite (BaSO_4)	0.3	0.01	0.01	0.8 x 0.65 x 0.56
Celestite (SrSO_4)	0.15	0.02	0.02	1.2 x 0.9 x 0.5
Anglesite (PbSO_4)	0.15	0.03	0.02	2.3 x 1.3 x 1.0

* $T = 94 + 5^\circ\text{C}$, Volume 2 liters in 6 liter flask, Flow rate 5-10 ml/hour

** Probably a maximum concentration for growing large crystals.

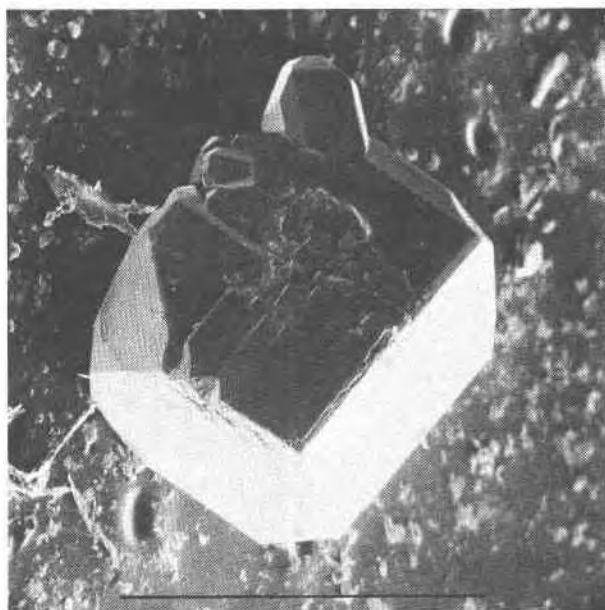

Fig. 2. Scanning electron microscope photo of barite crystal. Damaged surface shows cleavage. Bar is 0.5 mm long.

produce barite by some of the previously discussed procedures. Following Espig and Neels (1967), a 0.0033 molar BaCl_2 solution was rapidly mixed with a 0.0033 molar Na_2SO_4 solution at room temperature in a clean flask and allowed to stand for 72 hours before filtration. A fine precipitate was observed about 1 minute after the solutions were mixed. The resulting precipitate consisted of small 1-2 micron crystals. A few plate-like crystals up to 15 microns long were observed; however, these were so thin (2 microns) that they did not show any apparent birefringence and were very easily broken into smaller fragments. An attempt was also made to grow barite crystals in NaCl melts, following the procedure described by Patel and Bhat (1971). A mixture of BaSO_4 and NaCl was placed in a platinum crucible and heated to 900°C in a muffle furnace. The furnace was cooled in successive steps to 700°C and then shut off to cool. The BaSO_4 in the crucible had recrystallized to produce shard-like grains with numerous inclusions of NaCl . The platinum crucible also showed considerable etching and pitting.

The precipitation procedure used for the synthesis of sulfate minerals was used for precipitating the carbonate minerals witherite, BaCO_3 , and strontianite, SrCO_3 . Dilute (0.02 molar) BaCl_2 and SrCl_2 chloride solutions that were 0.001 molar in HCl were heated to $80\text{--}85^\circ\text{C}$ on a hot plate. A 0.02

molar NaHCO_3 solution was slowly added at a rate between 5 and 10 ml/hr until precipitation appeared complete. The precipitate was entirely crystalline with grains between 0.001 mm and 0.30 mm in length. The crystals were generally blade like with a width between 1/4 and 1/20 of their length. X-ray diffraction and optical parameters were identical to those obtained for natural witherite and strontianite. Several variations in the experimental procedure were employed in an effort to improve the quality of the precipitate. Reducing convection in the flask by placing the flask in a shallow oil bath resulted in some improvement. Further, surface-grown crystals were eliminated by redesigning the flask (Fig. 1b) so that the flask could be completely filled with solution. Rather large crystals (Fig. 7) up to about 1 mm grew at the tip of the inlet tube near the bottom of the flask. The excess solution escaped from the flask through an exit in the top of the cap piece.

Discussion

The simple precipitation procedure described in this report has been used many times for the synthesis of crystalline barite, celestite, and anglesite. Precipitates of these minerals (Figs. 2, 3, 4, and 5) generally consisted of many individual crystals of various sizes with a distinctive external morphology. Small crystal aggregates were also common. The

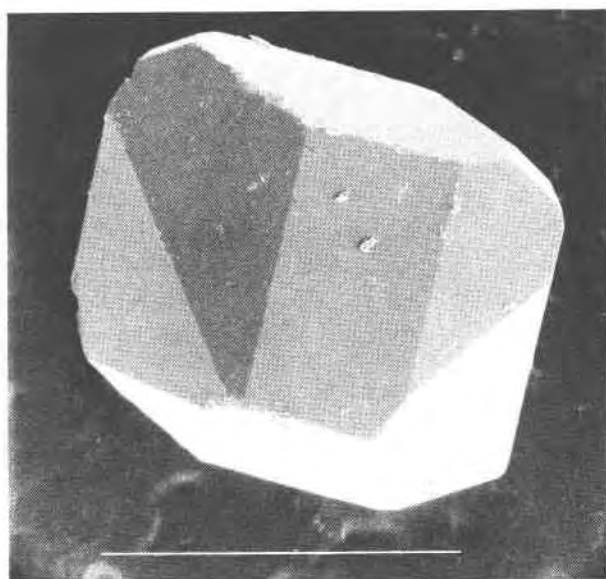

Fig. 3. Scanning electron microscope photo of celestite crystal. Bar is 0.5 mm long.

success of the procedure is due to establishing conditions that allowed slow growth to occur (from 0.01 to 0.1 mm/day) on a minimum number of crystals. No fine-grained (less than 0.002 mm) or optically amorphous material was observed in experimental syntheses carried out over a broad range of chemical conditions. Very fine-grained precipitates were obtained when solution concentrations significantly exceeded those listed in Table 1 (*e.g.*, barite or celestite precipitated from 0.1 molar solutions) or when other experimental conditions that degraded the precipitate—*e.g.*, stirring, use of plastic ware, poor cleaning, excessive combination rates—were used.

The perfection of individual crystals varied somewhat. The sulfate crystals grew on the glass surface in the solution. The crystal faces next to the glass surface were less well developed. Some crystals showed twinning, satellite crystals, and surface irregularities due to uneven growth. The larger crystals were generally more imperfect in their external morphology. The sulfate crystals had very small fluid inclusions that appeared to be filled. The external morphology, indices of refraction, and other optical properties were the same as for natural minerals. Interplanar spacings and peak intensities agree with values published in the X-ray Powder Data File.

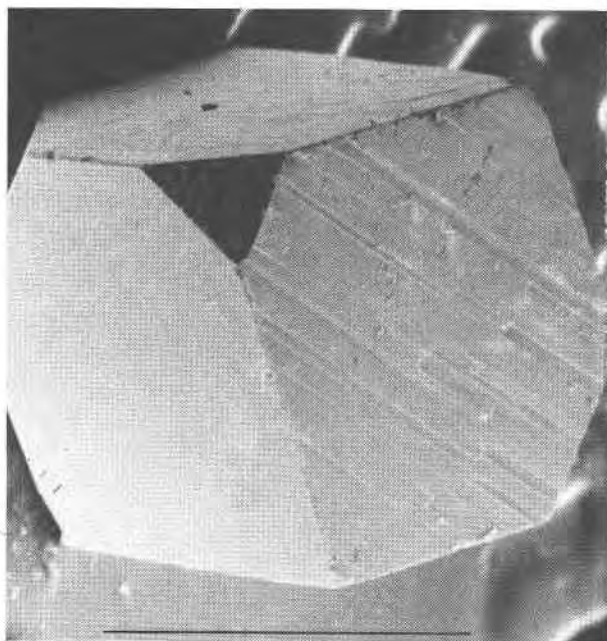

Fig. 4. Scanning electron microscope photo (oblique view) of anglesite crystal. Bar is 0.5 mm long.

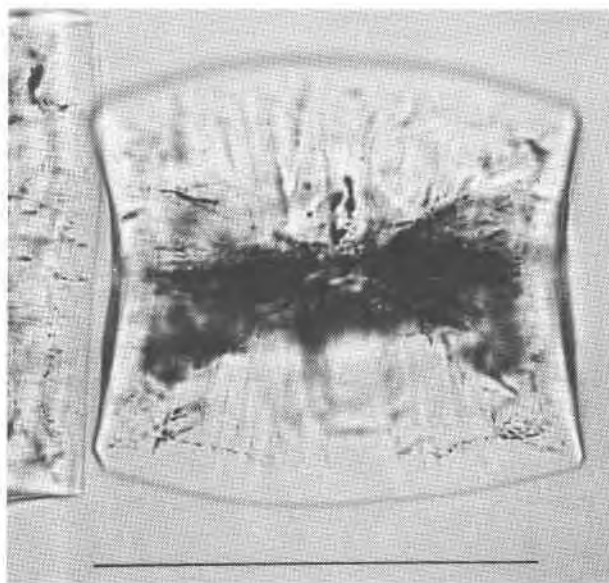

Fig. 5. Photomicrograph of strontium barite crystal (0.1 mole fraction Sr) in plain light. Bar is 0.05 mm long.

Variations in average crystal size occurred between successive precipitations of the sulfate minerals under seemingly identical conditions. The average crystal size increased as the quantity of crystals decreased. Crystals produced in poorly cleaned flasks were not only finer grained but occurred in streaks, suggesting that the presence of foreign matter on the glass surface may have aided nucleation. The presence of seed crystals did not prevent the nucleation of new crystals. Also, additional new crystals appeared in the flask after the appearance of the initial group of crystals. La Mer and Dinegar (1951) and Collins and Leineweber (1956) showed that the degree of supersaturation (concentration in excess of the solubility of the solid) necessary for nucleation was strongly dependent upon the content of foreign particulate matter (heteronuclei) that could serve as nucleation centers. Nucleation on heteronuclei required a supersaturation between 14 and 58 times the solubility for BaSO_4 . Walton (1963) and Mealor and Townshend (1966b) showed that homogeneous nucleation of BaSO_4 required a supersaturation factor near 1000. Homogeneous nucleation is characterized by the rapid appearance of vast numbers of new particles rather than nucleation on the heteronuclei already present in the solution. Homogeneous nucleation is clearly undesirable for the production of large crystals. Studies by Mealor and Townshend (1966a, b) suggest that true homo-

geneous precipitation would be very difficult to obtain. The precipitation of sulfate minerals described in this study must be on heteronuclei. Mealor and Townshend indicated that the number of heteronuclei in aqueous solutions is near 10^6 particles/cc. The formation of an estimated 10^6 to 10^7 crystals from liter quantities of solution suggests that some heteronuclei serve as crystallization centers much better than do many others. The very slow precipitation rate prevented the formation of crystals on most of the heteronuclei.

Nancollas (1968) showed that crystal growth rates depended upon the crystal surface area and the degree of supersaturation. When only a relatively small number of large crystals are present, the surface area is greatly reduced compared to an equivalent mass of very small crystals. Variations in addition rates would then cause larger variations in growth rates and the degree of supersaturation. Too rapid an addition rate could increase the level of supersaturation sufficiently to cause nucleation to take place on additional heteronuclei in spite of the presence of a solid precipitate. Growth rates of crystals would greatly increase under such conditions but morphological perfection would decrease. The use of persulfate-thiosulfate solutions to generate sulfate ion in solutions was not used because a much slower addition rate was desired than such a reaction produces. Most persulfate-thiosulfate precipitations were completed within 1–2 hours (*e.g.*, Mealor and Townshend, 1966a, b) with a significantly smaller crystal size. Slow precipitations were completed only after 3 to 20 days time. The preparation of large crystals of sulfate requires clean equipment and careful control of additional rates. The preparation of ultra-clean solutions with a low heteronuclei content seems to be unnecessary. If the larger heteronuclei are more favorable nucleation sites for the sulfate minerals, their removal could be detrimental. Smaller heteronuclei probably vastly outnumber larger ones. Nucleation on the smaller ones could result in the formation of larger numbers of crystals.

There is a considerable difference in maximum crystal sizes (Table 1). The order of increasing size agrees with the order of increasing solubility of the minerals reported by Blount and Dickson (1968), Strübel (1968) and Blount (1971). The solubility of these minerals in HCl solutions exceeds that in water alone and appears to increase with increasing temperature. Most of the crystals precipitated in the cooler part of the flask. A rough indication of rela-

tive solubility is provided by the amount of precipitating solution that must be added before precipitated crystals are observed in the flask. Barite precipitation required less Na_2SO_4 solution than celestite which in turn required less than anglesite. Solubility of anglesite in HCl solutions was markedly greater in hot than in cold solutions. A considerable amount of fine grained PbSO_4 was precipitated from filtered hot residual solutions after these solutions had cooled to room temperature. Similar precipitates were not observed in cooled solutions obtained from barite or celestite synthesis experiments. It appeared that carrying out the precipitation under conditions that enhanced the solubility of the sulfate minerals aided in the formation of larger crystals.

Most strontium-bearing barite crystals had the same general morphology as the pure barite or pure celestite crystals. At rather high strontium sulfate contents ($\text{Sr}/\text{Ba} = 0.1$ or greater), many crystals had a distorted barrel-shaped appearance (Fig. 5). These crystals showed extinction only along narrow bands that become constricted toward the center of the crystal. X-ray diffraction peaks for strontium barites were intermediate in position between those of barite and celestite. Slight broadening of the 002 and 111 diffraction peaks was observed as reported previously by Renault and Brower (1971). This broadening increased with increasing strontium content. Examination of these crystals using the electron microprobe suggested that the earliest formed portion of the crystal had a higher barium content. Results of spot analyses along the rim (last precipitated material) indicated that it was uniform to within ± 5 percent, the precision of the measurements.

A comparison between some solution and solid compositions for strontium barites (Fig. 6) indicates that a very high Sr concentration is required in solutions to produce appreciable coprecipitation of Sr in barites. Sr/Ba ratios in the solid vary between 1/30 to 1/80 of the Sr/Ba ratio in the solution. The scatter in the data is due to compositional variations in the experimental solutions. The mole ratios of Sr/Ba in the solution and in the solid are related by the equation,

$$\frac{\text{Sr}^{++}}{\text{Ba}^{++}} = \lambda \frac{\text{SrSO}_4}{\text{BaSO}_4}$$

in which λ is a distribution coefficient. Starke (1964) showed that λ varied with temperature, rate of growth, and solution composition. Hanor (1968) considered that a value of $\lambda = 33$ would fit his dis-

tribution model for the Sr-Ba sulfate solid solution series; however, values as high as 66 would also be possible. Most of the Sr barites synthesized in this study lie between the lines representing $\lambda = 33$ and $\lambda = 66$. Brower and Renault (1971) considered that the Sr-Ba sulfate solid solution series was ideal in behavior, so that λ is equal to the ratio of the thermodynamic solubility products ($K_{sp}SrSO_4/K_{sp}BaSO_4$) of pure Sr or Ba sulfate. K_{sp} values were estimated at 95°C from celestite and barite solubility data (Blount and Dickson, 1968; Blount, 1971). The ratio of the solubility products obtained from these previous solubility studies is 390. A λ value this large does not fit the results obtained during the present study, as shown in Figure 6.

The sulfate crystals produced by rapid precipitation or flux fusion were definitely less satisfactory. Possibly much better crystals could be made by these methods if the proper type of equipment was available and the procedures used by previous workers closely followed. The recrystallization of sulfate minerals along a thermal gradient, while possible, is quite slow, and the crystals produced are much smaller than those precipitated from solution. This

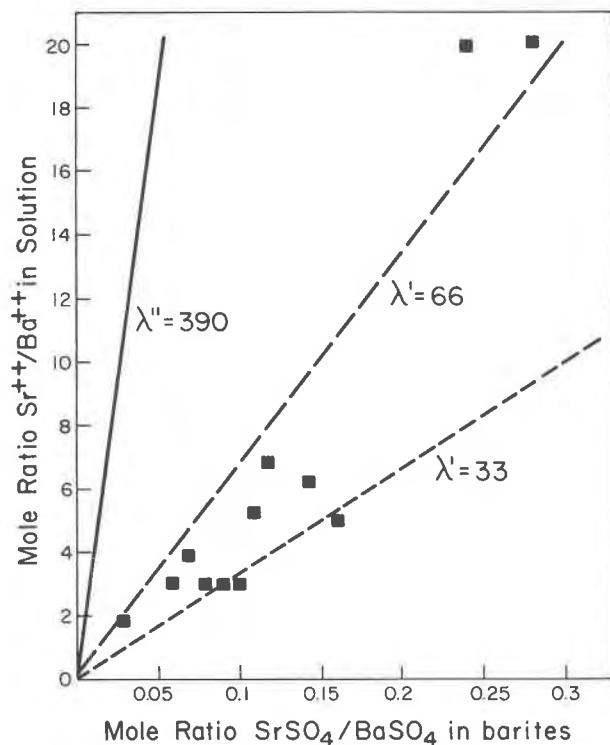

FIG. 6. Comparison of Sr/Ba mole ratios in strontium-barites with mole ratios in aqueous solutions.

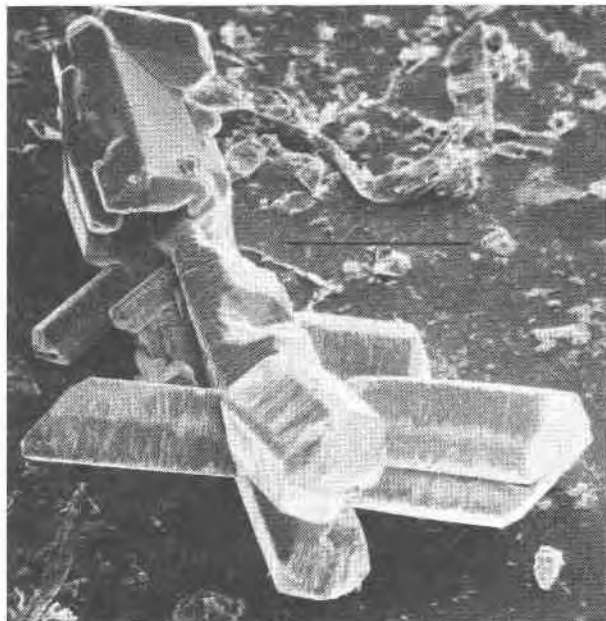

FIG. 7. Scanning electron microscope photo of witherite crystals. Bar is 0.1 mm long.

method was not thoroughly investigated because synthesis by combining solutions proved to be reliable, faster, and productive of larger crystals. Barite crystals prepared by the procedure described by Burkhard (1973) could be satisfactory for many types of studies. However, most crystals contain fluid inclusions that are filled with the solution in which they grew. Recrystallization would, in time, cause leakage from these inclusions and alter the composition of experimental solutions used for solubility and phase equilibria studies. The leakage from fluid inclusions filled with concentrated sulfuric acid would have a significantly greater effect than leakage from fluid inclusions filled with a 0.01 molar aqueous salt solution.

Witherite and strontianite crystals grew in a distinctly different manner than the sulfate minerals. Many of the crystals grew on the surface of the solution in contact with the CO₂ rich vapor phase. A large amount of the precipitate consisted of these small (1–10 micron) crystals. When the surface-grown crystals were eliminated, most of the precipitation took place at the end of the glass tube used to introduce the NaHCO₃ solutions. Very little precipitation took place on the bottom or sides of the flask. Some carbonate precipitated from the overflow solutions after they stood for several days. While some crystals grew to lengths in excess of 1 mm,

several percent of the crystals were less than 2 microns. No amorphous material was observed. It seemed that the carbonate crystals were more easily nucleated than were crystals of sulfate. As for sulfate crystals, variations in addition rates may result in the continued nucleation of crystals. While the product was satisfactory for experimental work on the alteration of sulfate and carbonate minerals (Blount and Beckman, 1974), further improvement in the quality of the carbonate precipitates may be possible by using solutions more dilute than 0.02 molar and by using a more reliable solution-addition method.

The use of the results of this study to suggest formation conditions for barium and strontium sulfate and carbonate minerals in nature is subject to question. Some possible restrictions with respect to the formation of coarse-grained hydrothermal barites are worth discussing. Laboratory synthesis experiments were made using clean equipment at strongly acidic conditions. Natural hydrothermal solutions were probably much less acidic and the environment certainly was not laboratory-clean. The growth of large crystals suggests that nucleation rates were very low. This also requires low levels of supersaturation. Growth rates then would have been very much slower than those observed under laboratory conditions.

Acknowledgments

This research was supported by the Earth Sciences Section, National Science Foundation, NSF Grant GA 1667. The assistance of M. Guill is gratefully acknowledged for much of the sample processing. Mr. Baskin made microprobe analysis of the Sr barite crystals.

References

- BLOUNT, CHARLES W. (1971) Barite solubility in water at temperatures to 250°C and pressures to 1000 bars. *Geol. Soc. Am. Abstr. Progr.* **3**, 508.
- , AND K. L. BECKMAN (1974) Barite-witherite and celestite-strontianite equilibria in $\text{Na}_2\text{SO}_4\text{-NaHCO}_3\text{-Na}_2\text{CO}_3\text{-H}_2\text{O}$ solutions. *Trans. Am. Geophys. Union*, **55**, 456–457.
- , AND F. W. DICKSON (1968) The solubility of celestite (SrSO_4) in H_2O from 50° to 250°C and 100 to 1500 bars. *Geol. Soc. Am. Spec. Pap.* **101**, 19.
- BOGAN, E. J., AND H. V. MOYER (1956) Effect of aging solutions of barium chloride on particle size of barium sulfate. *Anal. Chem.* **28**, 473–476.
- BRICKER, C. E., AND D. J. MYERS (1969) The effects of iron and thorium ions on the kinetics of precipitation of BaSO_4 . *U. S. Natl. Tech. Inform. Serv. P B Rep.* **1969**, No. **190570**, 35 p.
- BROWER, ELISE (1973) Synthesis of barite, celestite and barium-strontium sulfate solid solution crystals. *Geochim. Cosmochim. Acta*, **37**, 155–158.
- , AND J. RENAULT (1971) Solubility and enthalpy of the barium-strontium sulfate solid solution series. *New Mexico Bur. Mines Mineral Resour. Circ.* **116**, 21 p.
- BURKHARD, A. (1973) Optische und röntgenographische Untersuchungen am System $\text{BaSO}_4\text{-SrSO}_4$ (Baryt-Celestite). *Schweiz. Mineral. Petrogr. Mitt.* **53**, 185–197.
- COLLINS, F. C., AND J. P. LEINWEBER (1956) The kinetics of the homogeneous precipitation of barium sulfate. *J. Phys. Chem.* **69**, 389–394.
- ESPIG, H., AND H. NEELS (1967) Untersuchungen an Mikroekristallen aus Fällungen I. Die Sulfate von Strontium, Barium and Blei. *Kristall und Technik*, **2**, 401–413.
- FISCHER, R. B., AND T. B. RHINEHAMMER (1953) Rapid precipitation of barium sulfate. *Anal. Chem.* **25**, 1544–1548.
- , AND ——— (1954) Addition agents in analytical precipitations. *Anal. Chem.* **26**, 244–246.
- GORDON, LOUIS (1955) Slow precipitation processes. Application of precipitation from homogeneous solution to liquid-solid distribution studies. *Anal. Chem.* **27**, 1704–1707.
- GUNDLACH, H., D. STOPPEL, AND G. STRÜBEL (1972) Zur hydrothermalen Löslichkeit von Baryt. *Neues Jahrb. Mineral. Abh.* **116**, 321–338.
- HANOR, J. S. (1968) Frequency distribution of compositions in the barite-celestite series. *Am. Mineral.* **53**, 1215–1222.
- LAITINEN, H. A. (1960) *Chemical Analysis*. McGraw-Hill Book Co., New York. 611 p.
- LA MER, V. K., AND R. H. DINEGAR (1951) The limiting degrees of super-saturation of the sparingly soluble sulfates. *J. Am. Chem. Soc.* **73**, 380–385.
- LIESER, K. H. (1969) Steps in precipitation reactions. *Angew. Chem. Int. Ed., Eng.* **8**, 188–202.
- LITEANU, C., AND H. LINGNER (1970a) Niederschlagsbildung—I, Korngrösseverteilung der in einem Schnellmischapparat erhaltenen Bariumsulfatniederschläge. *Talanta*, **17**, 1045–1052.
- , AND ——— (1970b) Niederschlagsbildung—II, Einfluss einiger Faktoren auf die Korngrösseverteilung bei Bariumsulfatniederschlägen. *Talanta*, **17**, 1053–1058.
- MAGER, H., AND K. H. LIESER (1972a) Rekristallisation und Alterung von Strontiumsulfat, I. Rekristallisation nach Fällung aus verdünnten Lösungen. *Z. Physik. Chem. Neue Folge*, **79**, 288–297.
- , AND ——— (1972b) Rekristallisation und Alterung von Strontiumsulfat, II. Rekristallisation und Alterung nach der Fällung aus verdünnten Lösungen. *Z. Physik. Chem. Neue Folge*, **81**, 81–88.
- , AND ——— (1972c) Rekristallisation und Alterung von Strontium sulfat, III. Rekristallisation und Alterung nach der Fällung aus Konzentrierten Lösungen. *Z. Physik. Chem. Neue Folge*, **81**, 89–97.
- MEALOR, D., AND A. TOWNSHEND (1966a) Homogeneous nucleation of some sparingly soluble salts. *Talanta*, **13**, 1069–1074.
- , AND ——— (1966b) On homogeneous nucleation in barium sulphate precipitation from homogeneous solution. *Talanta*, **13**, 1191–1193.
- NANCOLLAS, G. H. (1968) Kinetics of crystal growth from solution. *J. Crystal Growth*, **3–4**, 335–339.
- NIELSEN, A. E. (1957) Nucleation in barium sulfate precipitation. *Acta. Chem. Scand.* **11**, 1512–1515.

- (1958) The kinetics of crystal growth in barium sulfate precipitation. *Acta. Chem. Scand.* **12**, 951–958.
- O'ROURKE, J. D., AND R. A. JOHNSON (1955) Kinetics and mechanism in formation of slightly soluble ionic precipitates. *Anal. Chem.* **27**, 1699–1704.
- PATEL, A. R., AND H. L. BHAT (1971) Growth of barite group crystals by the flux evaporation method. *J. Crystal Growth*, **11**, 166–170.
- , AND ——— (1972) Growth of single crystals of BaSO₄ and SrSO₄ from gels. *J. Crystal Growth*, **12**, 288–290.
- , AND J. KOSHY (1968a) Growth of barium sulphate single crystals by chemically reacted flux method. *J. Crystal Growth*, **2**, 128–130.
- , AND ——— (1968b) Etching of synthetic barite (BaSO₄) single crystals. *J. Appl. Crystallogr.* **1**, 172–175.
- RENAULT, J., AND E. BROWER (1971) X-ray line broadening in the barium sulfate-strontium sulfate series. *Am. Mineral.* **56**, 1481–1485.
- STARKE, R. (1964) Die Strontiumgehalte der Baryt. *Freiberg. Forsch. C* **150**.
- STRÜBEL, GUNTER (1968) Hydrothermale Lösungen, Experimentelle Untersuchungsergebnisse über hydrothermal-synthetische Lösungen bis 600°C and 2000 Bar. *Geol. Rundsch.* **58**, 259–273.
- TEMPLETON, C. C. (1960) Solubility of barium sulfate in sodium chloride solutions from 25° to 95°C. *J. Chem. Eng. Data*, **5**, 514–516.
- WALTON, A. G. (1963) Nucleation and the interfacial tension of sparingly soluble salts. *Mikrochim. Acta*, **1963**, 422–430.

Manuscript received, October 30, 1972; accepted for publication, May 28, 1974.