

Karlite, $Mg_7(BO_3)_3(OH,Cl)_5$, a new borate mineral and associated ludwigite from the Eastern Alps

GERHARD FRANZ

*Institut für Angewandte Geophysik, Petrologie und Lagerstättenforschung
Technische Universität Berlin, EB 310, Straße des 17. Juni 135
D 1000 Berlin 12, West Germany*

DIETRICH ACKERMAND

*Institut für Mineralogie der Universität Kiel
Olshausenstr. 40-60, D 2300 Kiel, West Germany*

AND EDDIE KOCH

*Mineralogisch-petrographisches Institut der Universität Basel
Bernoullistr. 30, CH 4056 Basel, Switzerland*

Abstract

Karlite, a new borate mineral with the idealized formula $Mg_7(BO_3)_3(OH,Cl)_5$ occurs in a clinohumite-chlorite marble associated with ludwigite at Schlegeistal, Zillertaler Alpen, Austria. The mineral is white to light green and has a silky luster. It occurs as aggregates of minute needles and prisms elongated parallel to c , as much as 10 mm long, which sometimes have rosette-like forms. Karlite is biaxial negative with a mean $2V$ of 24° , $\alpha = 1.589$, $\beta = 1.632$, $\gamma = 1.634$, $\gamma - \alpha = 0.045$, $X = c$, $Y = b$, $Z = a$; and is colorless in thin section. The (001) cleavage is perfect. The two most common forms are {110} and {100}. Hardness is 5.5. Streak is colorless.

Karlite is orthorhombic, $P2_12_12_1$, with $a = 17.929(5)$, $b = 17.600(5)$, $c = 3.102(1)\text{\AA}$, $Z = 4$, $G_{\text{calc}} = 3.02$, $G_{\text{meas}} = 2.80$ to 2.85 . The six strongest lines of the X-ray pattern (d , in \AA , intensity, hkl) are 2.21, 100, 810, 740, 441; 2.83, 92, 620; 2.25, 87, 251; 2.78, 82, 260, 221, 540; 12.53, 76, 110; and 2.89, 68, 160, 221, 121. IR spectra indicate that water is present as (OH) only. DTA shows only one strong nonreversible endotherm at 830°C . Melting occurs at 1345°C .

Combined microprobe, thermogravimetric and wet chemical analysis yielded SiO_2 0.02, TiO_2 < 0.01, B_2O_3 22.92, Al_2O_3 2.96, Cr_2O_3 < 0.01, FeO 2.27, MnO 0.17, MgO 58.90, CaO 0.14, K_2O 0.01, Na_2O 0.01, F 0.16, Cl 3.26, H_2O^+ 10.40, H_2O^- 0.63 (not included in total), total 101.22, $O \equiv F$ 0.82, corr. total 100.40.

The mineral is named in honor of Prof. Dr. Franz Karl, late professor of mineralogy and petrography at the Christian Albrechts University, Kiel, West Germany; in recognition of his geologic studies of the Eastern Alps.

Introduction

Karlite was found in the Furtschaglkar near the Furtschaglhaus in the Schlegeistal, Zillertaler Alpen, Austria. It occurs in calcsilicate-carbonate lenses which are embedded in amphibolites.

The mineral was named in honor of Prof. Dr. Franz Karl (1918-1972), late professor of mineralogy

and petrography at the Christian Albrechts Universität, Kiel, West Germany. Prof. Karl mainly investigated the "Zentralgneis" complex of the Tauern window and gave great stimulation to geological studies of the Eastern Alps.

Type material will be preserved at the Mineralogisches Institut und Museum der Universität Kiel, Olshausenstr. 40-60, D 2300 Kiel, West Germany,

and at the Institut für Mineralogie und Kristallographie, Technische Universität Berlin, Straße des 17. Juni 135, D 1000 Berlin 12, West Germany. The new mineral and the name were approved by the Commission on New Minerals and Mineral Names, IMA, prior to publication.

Physical properties

The mineral is white to light green, partly with a brown weathering crust, and has a silky luster. It forms aggregates of minute needles and small fibers, sometimes up to 10 mm long, with an average individual crystal size of 0.5 mm by 0.002 mm. It always occurs in aggregates, sometimes in rosette-like forms. At a first glance it resembles tremolite-actinolite.

Hardness was determined by scratching the mineral in a polished thin section with reference hardness standards (Mohs scale) as 5.5. Aggregates of karlite were mounted on top of a needle and used to scratch standard minerals, which gave the same results. The hardness of associated ludwigite was determined as 5.5 as well (with the latter method only).

Specific gravity was determined by the suspension method. Crystal aggregates of 1 to 1.5 mg gave values of $D = 2.80$ to 2.85 gcm^{-3} (6 determinations). Calculation using a molecular weight of 445.00 from the analysis gave $D = 3.02 \text{ gcm}^{-3}$. Cleavage parallel to (001) is perfect.

Optical properties

The mineral is colorless in thin section. Sometimes it is surrounded by a brownish rim. Figure 1 shows a typical aggregate of crystals parallel (a) and perpendicular (b) to the needle axis. $\{110\}$ and subordinately $\{100\}$ are developed. Extinction is parallel to the needle axis, but typically undulatory. Figure 2 shows that even a crystal that looks like a true single crystal consists of small needles, oriented more or less parallel to the needle axis.

Refractive indices were determined by means of a Wilke microscope refractometer. Since it was not possible to orient the crystals properly, only the refractive index parallel to the needle axis and a larger index perpendicular to the needle axis could be determined. The third index was calculated using $2V_x$, α , and γ . The optic axial angle was determined conoscopically with the universal stage. It varies between 22° and 25° with a mean value of 23.7° . The mineral is optically negative. No strong dispersion was observed. Optical data are presented in Table 1, and the optical orientation scheme is given in Figure 3.

X-ray crystallography

Lattice constants (see Table 1) were measured from a small crystal with a Philips automatic four circle diffractometer and then refined by least squares methods (program PULVER, Min. Inst. TU Berlin). X-ray powder data indexed with the same program were obtained with a Philips diffractometer, $\text{CuK}\alpha$ radiation, graphite monochromator, measured against Si as an internal standard (see Table 2)¹.

The mineral is orthorhombic, $P2_12_12_1$; $h = 2n$, $k = 2n$ and $l = 2n$ are the only systematic extinctions observed. Because of the large lattice constants and relatively low symmetry, the X-ray powder diagram contains a large number of lines. The indexing and refining procedure was made with 54 lines out of 120 lines between 5 and $75^\circ 2\theta$. The agreement between measured and calculated data is good; but at diffraction angles higher than $55^\circ 2\theta$, the reflections could not be indexed precisely.

Three reflections could not be indexed. They probably belong to another borate phase as will be shown below. Several other lines of the powder diagram may belong to this phase also. Due to the large number of possible lines of an orthorhombic phase with large lattice constants it cannot be determined unequivocally to which phase they belong. The other borate may be present in minor amounts only. Microscopic examination of the samples which were used for powder diffractometry showed no impurities.

Chemistry

Chemical analysis was made with electron microprobe, wet chemical, and thermogravimetric methods (Table 3). Material for wet chemical and TGA analysis (as well as for X-ray investigations) was obtained by crushing a bulk sample in an agate mortar; the borate phase separated by magnetic separator and subsequently washed with dilute cold HCl to clean the sample from intergrown calcite and dolomite crystals. Both X-ray diffraction patterns and IR spectra showed no differences before and after treatment with HCl. Therefore we conclude that the mineral is not corroded by dilute cold HCl.

Thermogravimetric analysis (Analyzer Dupont 950) yielded a total weight loss between 20°C and 950°C of 12.1 wt.%. Between 20°C and 110°C , there

¹ To receive a copy of this table, order Document AM-81-166 from the Business Office, Mineralogical Society of America, 2000 Florida Avenue, N.W., Washington, D.C. 20009. Please remit \$1.00 in advance for the microfiche.

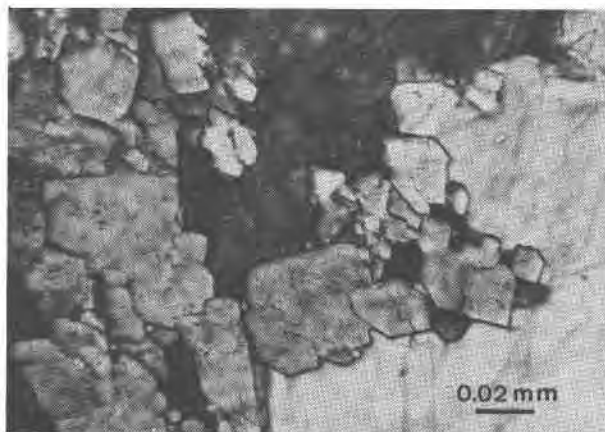
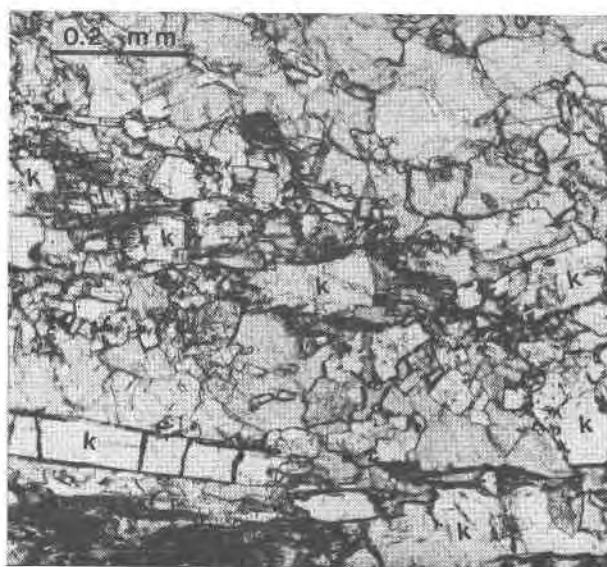

Fig. 1. Photomicrograph of karlite (k). Fig. 1a is typical of the fibrous and needle like character of the mineral. Fig. 1b shows the pseudotetragonal morphology with $\{110\}$ and subordinate $\{100\}$.

is a weight loss of 0.63% corresponding to H_2O^- . Gradual further weight loss takes place between $110^\circ C$ and $680^\circ C$ with 0.9 wt.%. The largest weight loss occurs between $680^\circ C$ and $850^\circ C$ and amounts to 9.5 wt.%. Total H_2O^+ is therefore 10.4 wt.%. Above $850^\circ C$ gradual weight loss is observed. Ignition loss at $800^\circ C$ is 10.97 wt.%.

B_2O_3 was determined photometrically with dianthrimid and by distillation as boric acid methyl-ester. Both analyses yielded similar results with 22.99

and 22.84 wt.% respectively. All other elements were determined by electron microprobe. The probe standards were TiO_2 , Al_2O_3 , Cr_2O_3 , MgO , metallic Fe and Mn, wollastonite for Si and Ca, K-Na-glass and apatite for F and Cl.

In addition to karlite and ludwigite (see occurrence and associations) another (borate?) phase was found by microprobe analysis, where MgO (61.47), TiO_2

Table 1. Physical and crystallographic properties of karlite

$\alpha = 1.589$	Cell constants
$\beta = 1.632$	$\underline{a} = 17.929(5)\text{\AA}$
$\gamma = 1.634$	$\underline{b} = 17.600(5)\text{\AA}$
$\Delta n = 0.045$	$\underline{c} = 3.102(1)\text{\AA}$
$2V_x(\text{measured}) = 22^\circ - 25^\circ$	$\alpha = \beta = \gamma = 90^\circ$
Dispersion : not observed	$V = 978.3 \text{\AA}^3$
$D(\text{measured}) : 2.80-2.85 \text{ g cm}^{-3}$	$Z = 4$
$D(\text{calculated}) : 3.02 \text{ g cm}^{-3}$	$\underline{a} : \underline{b} : \underline{c} =$
Cleavage : (001) perfect	$1.019 : 1 : 0.176$
Color : white-green	
	colorless in thin sections
Streak : colorless	
Hardness : 5.5	

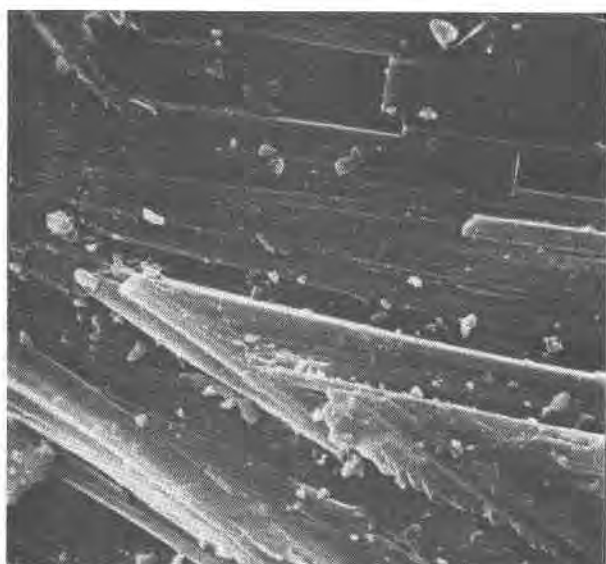

Fig. 2. SEM photograph of karlite showing the parallel and subparallel intergrowth of small fibers. Horizontal white bar is 2 μm .

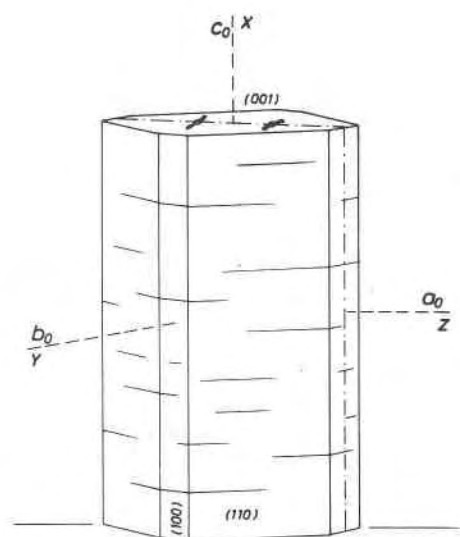

Fig. 3. Optical orientation scheme of karlite.

(0.26) and F (0.33) values are a little higher than those of karlite, but FeO (0.71 wt.%) is significantly lower. Al₂O₃ as well as Cl is absent. It is assumed that this unidentified phase produced the non-indexed reflections of the X-ray diffraction pattern.

IR-data and thermal study

The IR-spectrum (Fig. 4) clearly shows that water is present as (OH) only, not as molecular water. This is consistent with the DTA curve (Fig. 5) where only one strong nonreversible endothermic effect is observed at 830°C. The phases which are produced by loss of (OH) at 830°C are kotoite (Mg₃(BO₃)₂) and periclase (MgO); X-ray data are presented in Table 4. The decomposition starts at approximately 700°C. Melting occurs at 1345°C. After cooling from 1500°C to room temperature, periclase, kotoite, and another Mg-borate, (Mg₂B₂O₃; triclinic), crystallized from the melt. Additional reflections in the powder diagram are similar to the X-ray data of azoproteite (Konev *et al.*, 1970), but this phase could not be identified unequivocally.

The IR-spectrum shows strongest absorption at 1215 cm⁻¹. This band corresponds to the vibration of (BO₃) groups (Farmer, 1974) as well as another strong absorption at 735 cm⁻¹. The comparison with the IR spectrum of ludwigite from the same locality shows that especially in the range 1300 cm⁻¹ to 1500 cm⁻¹ subordinate bands are present which cannot be attributed to (BO₃) groups. Comparison with the spectra of ascharite and sussexite (Farmer, 1974) may lead to the assumption that B₂O₃ may be present as well, but this is highly hypothetical. No indications for the presence of BO₄ tetrahedra were found. This

is consistent with the fact that they are too large for a unit cell where one parameter is only 3.1Å.

Conclusions

The new mineral described here is a hydroxyl bearing magnesium orthoborate with minor amounts of aluminum and iron substituting for magnesium and with chlorine and minor amounts of fluorine substituting for hydroxyl groups. The ratio of total metallic cations to boron is very close to 7:3 and the empirical formula is calculated on the basis of metallic cations + boron = 10 as:

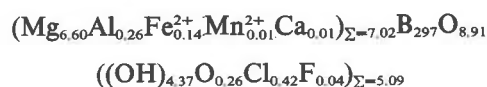

Table 3. Microprobe analysis of karlite and associated ludwigite

	karlite	ludwigite
weight-% oxides *		
SiO ₂	0.02	0.03
TiO ₂	<0.01	0.73
B ₂ O ₃	22.92	n.d.
Al ₂ O ₃	2.96	1.09
Cr ₂ O ₃	<0.01	0.05
FeO	2.27	40.34
MnO	0.17	0.17
MgO	58.90	38.20
CaO	0.14	0.06
K ₂ O	0.01	<0.01
Na ₂ O	0.01	<0.01
F	0.16	n.d.
Cl	3.26	n.d.
H ₂ O ⁺	10.40	n.d.
H ₂ O ⁻	0.63	n.d.
total	101.22	80.67
- O for (F,Cl)	0.82	
	100.40	

* Total Fe = FeO; B₂O₃ determined wet chemical; H₂O⁺ and H₂O⁻ by TGA; n.d. = not determined; H₂O⁻ not included in the total.

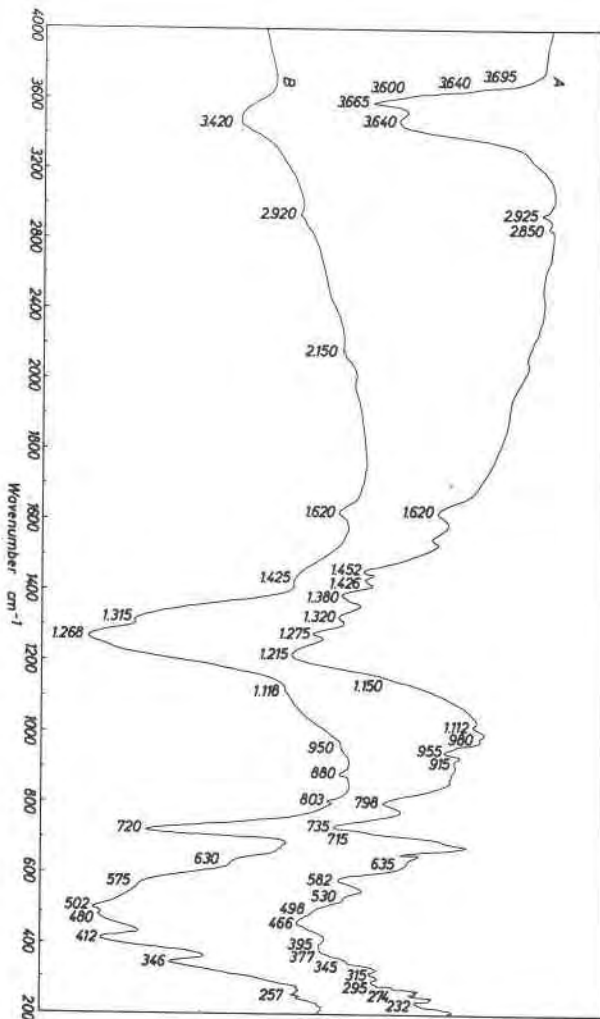

Fig. 4. IR spectra of karlite (= A) and Mg-rich ludwigite (= B) from the same locality. Interpretation is given in text. Wavenumber cm^{-1} is plotted against percent transmission.

provided that the valency compensation due to the substitution of Al for Mg is made by O substituting for (OH) in the last parenthesis. The ideal formula $\text{Mg}_7(\text{BO}_3)_3(\text{OH},\text{Cl})_5$, with $\text{OH} > \text{F}$ is preferred from the result of infrared spectral study and space group requirements.

From its chemical composition the mineral is similar to the nocerin ($\text{Mg}_3\text{F}_3\text{BO}_3$)–fluoborite ($\text{Mg}_3(\text{OH},\text{F})_3\text{BO}_3$) series. The main difference is the presence of aluminum and chlorine in karlite. Nocerin-fluoborite is hexagonal with $a = 8.86$ to 9.06\AA , $c = 3.13$ to 3.06\AA (Strunz, 1977). The orthorhombic cell of karlite corresponds to the hexagonal cell of nocerin-fluoborite with $2a$ (hex) = $18\text{\AA} \approx a$ (o'rh) = 17.9\AA , and c (hex) = $3.1\text{\AA} = c$ (o'rh); b (o'rh) = 17.6\AA is slightly larger than a $\sqrt{3}$ (hex) = 15.6\AA .

Geological setting and associated minerals

The mineral was found in a small calcsilicate marble lens (approximately 1 m thick and several m long) 400 m southeast of the Furtschaglhaus, (Schlegeistal, Zillertaler Alpen, Austria) near the path to the Gr. Möseler. The marble is embedded in amphibolite, and this amphibolite is located at the border zone between the two tectonic units "Zentralgneis" and "Schieferhülle". A detailed description of the mineralogy of the marble and the geological and petrological aspects is given elsewhere (Franz and Ackermann, 1980).

It is assumed that the high boron concentration necessary for the formation of karlite is due to a contact metasomatism produced by Hercynian tonalitic magmas, which formed the "Zentralgneis". The actual mineral assemblage, and very probably karlite as well, were formed during the alpine metamorphism.

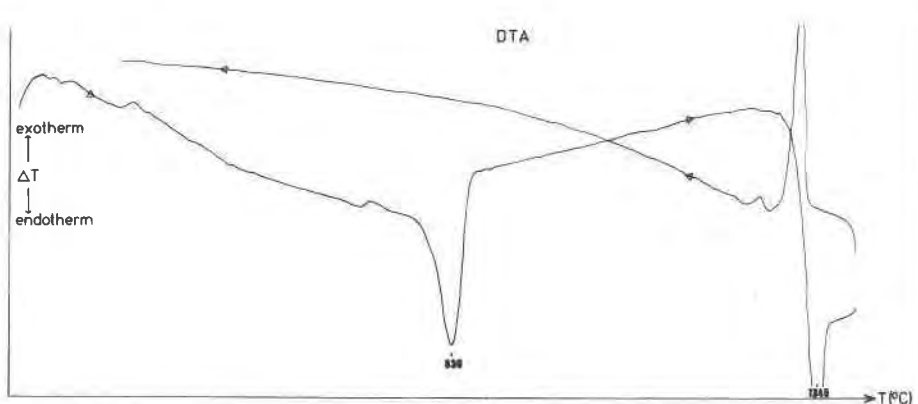

Fig. 5. DTA heating and cooling curve of karlite; dehydration occurs at 830°C and melting at 1345°C .

Table 4. X-ray powder data of breakdown products of karlite

d_{obs}	I/I_0	kotoite (ASTM file No.5-0648)			I/I_0
		d	h k l		
4.23	50 koto	4.23	0 2 0	25	
		4.00	0 1 1	15	
		3.47	1 0 1	75	
3.21	20 "	3.21	1 1 1	50	
		2.67	1 2 1	100	
2.67	95 "	2.49	1 3 0	50	
		2.39	0 3 1	40	
		2.31	2 0 1	75	
2.36	25 "	2.27	2 2 0	40	
		2.23	2 1 1	100	
		2.18	1 3 1	100	
2.11	(70) peri	-	-	-	
2.03	10 koto	2.08	1 0 2	40	
		2.03	2 2 1	15	
		2.01	1 1 2	15	
1.80	25 "	1.98	0 2 2	15	
		1.80	1 4 1	25	
		1.73	2 0 2	100	
1.73	55 "	1.73	1 1 2	15	
		1.67	1 3 2	100	
		1.64	3 1 1	15	
1.67	65 "	1.61	1 5 0	15	
		1.58	0 5 1	35	
		1.55	3 2 1	50	
1.52	35 "	1.54	0 4 2	25	
		1.51	3 3 0	100	
		-	-	-	
1.49	(30) peri	-	-	-	
1.44	10 koto	1.48	0 1 3	50	
		1.43	3 3 1	15	
		1.41	0 6 0	50	

Other minerals occurring together with karlite are calcite, dolomite, chlorite, clinohumite, brucite, and ludwigite. The non-borate phases are described by Franz and Ackermann (1980). Since the accompanying borate mineral ludwigite (Mg,Fe^{2+}) $_2\text{Fe}^{3+}(\text{O}_2/\text{BO}_3)$ has not been found in the Central Eastern Alps up to now, a brief description is included.

The ludwigite crystals are mostly euhedral forming long needles of up to 10 to 50 mm length with a rhombic cross section $\{110\}$, mostly 0.1–0.9 mm wide. The crystals occur irregularly dispersed in the carbonate matrix as well as enriched along schistosity planes.

Under the microscope they are translucent with strong green-red-brown pleochroism or are nearly opaque. Partial chemical analysis (see Table 3) shows that it is a Mg-rich member of the ludwigite-vonsenite group. Al_2O_3 contents are low (about 1 wt.%). According to Alexandrov *et al.* (1965) the minerals of this group can be distinguished by means of IR-spec-

troscopy. Fe^{2+} rich members of this crystalline solid solution series (ferroludwigite and vonsenite) show a typical absorption band at 620 cm^{-1} and a shifting of the bands at 1280 and 730 cm^{-1} to 1230 and 705 cm^{-1} respectively. Magnesioludwigites possess an additional band at 1320 cm^{-1} . All these characteristics were observed in the spectrum of ludwigite from Furttschagl (Fig. 4) and therefore it is classified as a magnesio-ludwigite.

The members of this group can not clearly be distinguished by X-ray methods (Leonard *et al.*, 1962). Refined lattice constants from diffraction powder data gave: $a = 9.3(2)$; $b = 12.3(2)$; $c = 3.030(7)\text{ \AA}$, which is consistent with the classification given above.

Acknowledgments

We wish to express our sincere thanks to G. Morteani for his encouraging interest in this work as well as for his assistance during field work. W. E. Klee measured the IR-spectra. K. Hesse performed the automated four circle diffractometer studies, and H. Springer the TGA and DTA analysis. C. Tennyson, E. Foord, and A. Kato critically read the manuscript. Their help is gratefully acknowledged. We want to express our thanks to the DFG for providing travel expenses (Mo 232/7) and to the Volkswagen foundation for procuring the microprobe.

References

- Alexandrov, S. M., Akhmanova, M. V., and Karyakin, A. V. (1965) Investigation of the ludwigite-vonsenite group of borates by means of their infrared spectra. (transl. Geochemistry International, 2, p. 823–827, 1965) Geokhimiya, No. 9, 1114–1118.
- Farmer, V. C. (ed.) (1974) The IR-spectra of minerals. London: Mineralogical Society Monograph 4.
- Franz, G. and Ackermann, D. (1980) Phase relations and metamorphic history of a clinohumite-chlorite-serpentine marble from the western Tauer area (Austria). Contributions to Mineralogy and Petrology, 75, 97–110.
- Konev, A. A., Lebedeva, V. S., Kashaev, A. A., and Ushchapovskaya, Z. F. (1970) Azoproite, a new mineral of the ludwigite group. Zapiski Vsesoyuznogo Mineralogicheskogo Obshchestva, 99, 225–231.
- Leonard, B. F., Hildebrand, F. A., and Vlisidis, A. C. (1962) Members of the ludwigite-vonsenite series and their distinction from ilvaite. Petrological Studies Geological Society of America. (Buddington Vol.), 523–568.
- Strunz, H. (1977) Mineralogische Tabellen. Akademische Verlagsgesellschaft Geest + Portig, Leipzig.

Manuscript received, July 2, 1980;
accepted for publication, February 16, 1981.