

## Dehydration and hydration of montmorillonite at elevated temperatures and pressures monitored using synchrotron radiation

WUU-LIANG HUANG

Exxon Production Research Company, P.O. Box 2189, Houston, Texas 77252-2189, U.S.A.

WILLIAM A. BASSETT, TZY-CHUNG WU

Department of Geological Sciences, Cornell University, Ithaca, New York 14853, U.S.A.

### ABSTRACT

Na-saturated montmorillonite hydrate with three layers of H<sub>2</sub>O in the interlayer ( $d_{001} = 17.65\text{--}18.56 \text{ \AA}$ ) was found to be stable up to 340 °C and  $2 \pm 1$  kbar of H<sub>2</sub>O pressure using a diamond-anvil cell by real-time diffraction using X-rays from the Cornell High Energy Synchrotron Source (CHESS). It dehydrates to montmorillonite with two H<sub>2</sub>O layers at higher temperature ( $d_{001} = 15.38 \text{ \AA}$ ). The hydrate with two H<sub>2</sub>O layers, in turn, dehydrates to montmorillonite with one H<sub>2</sub>O layer at 483 °C and  $4.4 \pm 1.3$  kbar ( $d_{001} = 12.56 \text{ \AA}$ ). The montmorillonite hydrate with one H<sub>2</sub>O layer dehydroxylates or melts at 525 °C and  $5 \pm 1.4$  kbar, conditions that are much lower than those found at lower pressures. Montmorillonite with basal spacing intermediate between two homogeneous states, which was interpreted as interstratification of two hydrates, is also stable at the elevated temperatures and pressures. Results confirm that the dehydration temperature of montmorillonite significantly increases with increasing H<sub>2</sub>O pressure, consistent with the idea that the density of interlayer H<sub>2</sub>O in montmorillonite is higher than that of pore H<sub>2</sub>O. Kinetic data show that the dehydration of interlayer H<sub>2</sub>O is fast (on the order of minutes) even at high H<sub>2</sub>O pressure, whereas the rehydration reaction is slower. The rehydration rate significantly increases when the sample cools to temperatures far below equilibrium. The preliminary experiments using micrograms of swelling clay, montmorillonite, affirm that synchrotron radiation can be a very useful tool to quantify the fluid-rock reactions occurring within a diamond-anvil cell.

### INTRODUCTION

The hydration state and structural configuration of interlayer H<sub>2</sub>O in smectite or montmorillonite are of great interest not only to clay mineralogists but also to those who study well-bore stability or abnormal subsurface pressure. Factors controlling the hydration state of smectite include smectite composition (total layer charge and charge location), interlayer cation (type, valency, and hydration energy), and environments (humidity or vapor pressure, temperature, and H<sub>2</sub>O pressure) (see Sato et al., 1992, and Colten-Bradley, 1987, for a review). Kawano and Tomita (1991) emphasized the importance of cation radius and the location of layer charge on the rehydration properties of smectite. The structural configuration and the consequent density of interlayer H<sub>2</sub>O, however, are much less conclusive (Farmer and Russell, 1971; Burst, 1969; MacEwan and Wilson, 1980). These parameters—hydration state, dehydration temperature, hydrostatic or differential pressures, and density of interlayer H<sub>2</sub>O—are of particular interest to sedimentary geologists because H<sub>2</sub>O released from smectite is considered an important contribution to the formation of overpressure and the migration of subsurface fluids (Hanshaw and Bredehoeft, 1968; Burst, 1969). Colten-Bradley (1987) evaluated the

effect of pressure on the temperature of interlayer H<sub>2</sub>O dehydration of smectite at diagenetic conditions and concluded that the dehydration of smectite in low-permeability shale might cause overpressure, but the resulting pressure increase will inhibit further reaction.

Experiments on the dehydration and hydration of smectite have been studied at atmospheric pressure (e.g., van Olphen and Fripiat, 1979), controlled humidity (e.g., Moore and Hower, 1986; Sato et al., 1992), and elevated pressures (e.g., Koster van Groos and Guggenheim, 1984; Colten, 1986). Moore and Hower (1986) and Sato et al. (1992) found that up to three H<sub>2</sub>O layers are stable in dioctahedral smectites, depending on the relative humidity. Stone and Rowland (1955) first measured the dehydration temperature of Ca-rich montmorillonite at up to 6 bars of H<sub>2</sub>O pressure using differential thermal analysis (DTA). They found that the temperature of the first dehydration (two to one layer of H<sub>2</sub>O) of montmorillonite interlayer H<sub>2</sub>O increases with H<sub>2</sub>O pressure, from 150 °C at 1 bar to 240 °C at 6 bars, whereas the temperature of the second dehydration (one to no layer of H<sub>2</sub>O) increases from 250 °C at 1 bar to 328 °C at 6 bars. Khitarov and Pugin (1966) concluded that the dehydration of Ca-saturated montmorillonite occurs at 130 °C at 1 bar and increases at a rate of 9.3 °C/kbar up to 15 kbar. Koster

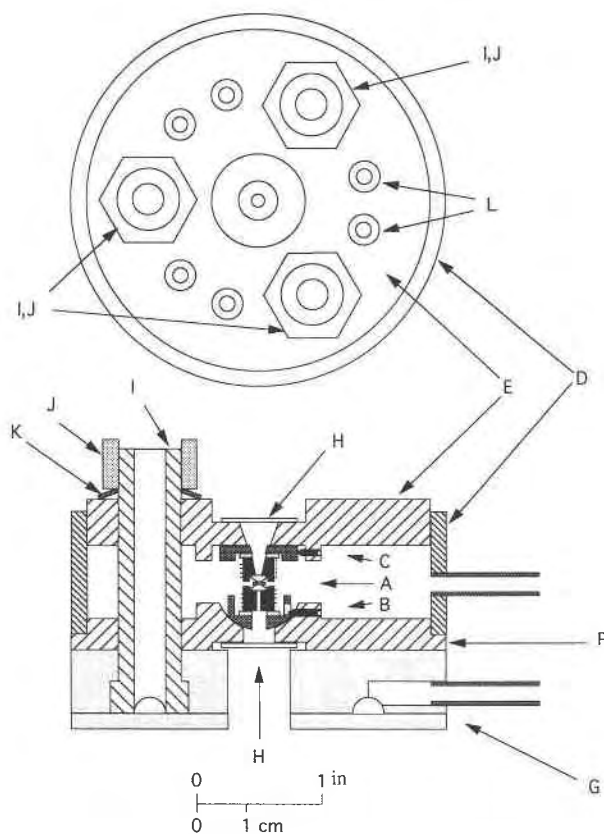

Fig. 1. Plan and elevation of the new diamond-anvil cell. The diameter of the cell is 3 in., and the height is 2.25 in. The parts are as follows: A = the sample, diamond anvils, heaters, and ceramic heat barriers; B = the ball joint for orienting the lower anvil; C = the sliding disk for positioning the upper anvil; D = the cylinder enclosing inert gas chamber; E = the upper platen; F = the lower platen; G = the base with the cooling chamber; H = the upper and lower windows (glass or mica); I = three posts; J = nuts on threaded parts of posts for applying force; K = bellville springs; L = the electric feed-through. The base is constructed of brass; the platens, posts, and cylinder are constructed of stainless steel.

van Groos and Guggenheim (1984, 1986, 1987a, 1987b) investigated the effect of pressure on the dehydration temperature of SWy-1 montmorillonite saturated with a variety of cations using high-pressure DTA up to 1.5 kbar. Their results show that the dehydration temperature increases rapidly with increasing H<sub>2</sub>O pressure within the first 500 bars and then slowly with further increases of pressure. They also found that the two dehydration reactions occur at similar temperatures (a separation of 50 °C) and that the reaction curves are subparallel to but at a slightly higher temperature than the liquid-vapor curve of H<sub>2</sub>O.

Most of the previous experiments were performed using DTA methods. Although high-pressure DTA has been used widely to monitor dehydration or phase transitions of many reactions, the interpretation of high-pressure

DTA data requires an independent calibration such as thermodynamic calculations or quench experiments to assign the observed thermal response to a reaction. Steinfink and Gebhart (1962) examined the hydration state of smectite at 25 °C under differential stress using X-ray diffraction. Colten (1986) studied the hydration state of Na-saturated montmorillonite at elevated temperatures and H<sub>2</sub>O pressures by monitoring the  $d_{003}$  and  $d_{005}$  values of montmorillonite using a high-temperature, high-pressure X-ray device. She found that montmorillonite with two layers of H<sub>2</sub>O in the interlayer is stable at temperatures between 50 and 200 °C and at pressures up to 456 bars. However, she was unable to measure  $d_{001}$  and did not observe any dehydration reactions, probably because high temperatures were not reached. The present study examines the hydration and dehydration behavior of Na-saturated montmorillonite over a wide range of pressure and temperature using the newly developed hydrothermal diamond-anvil cell (Shen et al., 1992). The interlayer spacings of montmorillonite hydrates are monitored using X-ray diffraction from the Cornell High Energy Synchrotron Source (CHESS).

## EXPERIMENTAL METHODS

### Starting materials

The montmorillonite used in this study is Na-saturated montmorillonite purified from SWy-1 reference clay (Wyoming bentonite). The montmorillonite clay sample was dispersed in distilled, deionized H<sub>2</sub>O and centrifuged to remove the >2- $\mu$ m size fraction of particles before further purification and Na exchange. It was then checked for quartz or carbonate contamination by X-ray diffractometry. If non-negligible contamination was still present, the clay was centrifuged again at a slightly higher speed until the contamination was removed. The clay was then exchanged with Na. The Na exchange was effected by a series of washings with NaCl solution (1 M). The Na-exchanged clays were then dried in an oven under vacuum at 105 °C and ground to pass through sieves 0.12 mm in size (about 100 mesh). The grinding process produced a particle-size distribution with no clay aggregate larger than 0.12 mm. An air-dried sample with no special preparation for preferred orientation was mixed with distilled H<sub>2</sub>O and loaded into the sample chamber. The amount of sample used was on the order of micrograms and could not be measured accurately.

### Apparatus and procedures

The diamond-anvil cell (Fig. 1) was modified from that used by Furnish and Bassett (1983) and Shen et al. (1992). The sample microchamber between the two diamond anvils was a hole 400  $\mu$ m in diameter in a disk-shaped Re gasket 125  $\mu$ m thick and having an o.d. of 3 mm. The desired pressure was controlled by the amount of H<sub>2</sub>O added (i.e., the percent that the H<sub>2</sub>O fills the microchamber). The pressure was not constant but varied with the change in temperature during the experiment. In general,

the H<sub>2</sub>O pressure at each temperature was determined according to the liquid-vapor curve of H<sub>2</sub>O up to the homogenization temperature (i.e., the temperature at which the vapor bubble disappeared). The pressure was then determined using the equation of state of H<sub>2</sub>O (Shen et al., 1992). However, in the present study, the homogenization temperature was estimated by the starting volume ratio of H<sub>2</sub>O to the bubble (i.e., the percent of H<sub>2</sub>O present) in the sample chamber because the microscopic observation could not be made during the X-ray experiment. Temperatures were measured using chromel-alumel thermocouples, with their junctions closely contacting the pavilion faces of the diamond anvils, and were considered to be accurate to  $\pm 3$  °C. The heating elements consisted of 0.25-mm molybdenum wire wound around WC seats for the diamond anvils. To prevent the oxidation of the heating wires and diamond anvils at high temperatures, Ar gas with 1% H<sub>2</sub> was circulated around the heating elements. Detailed experimental procedures were reported in Shen et al. (1992).

The  $d_{001}$  value of montmorillonite was monitored by X-ray diffraction at high temperature and pressure using synchrotron radiation at CHESS. The X-ray experiments were carried out in an energy-dispersive mode with a constant  $3^\circ 2\theta$ . The low angle setting of  $2\theta$  was necessary for detecting  $d$  values up to 20 Å. The  $d$  values were internally calibrated using  $d_{110}$  or  $d_{020}$  of montmorillonite at 4.48 Å (van Olphen and Fripiat, 1979).

Three major experiments using montmorillonite with different hydration states were carried out to define the dehydration temperature of montmorillonite as a function of H<sub>2</sub>O pressure. In experiment 1 montmorillonite + H<sub>2</sub>O filled about  $85 \pm 5\%$  of the sample chamber. The sample chamber remained sealed throughout the experiment. The initial X-ray diffraction pattern of the sample with H<sub>2</sub>O shows a basal spacing of 18.3 Å, indicating montmorillonite with three layers of H<sub>2</sub>O. Experiment 2 used montmorillonite with H<sub>2</sub>O just enough to show the diffraction pattern of the starting sample in a sealed chamber with a basal spacing of 15 Å, indicating a hydrate with two H<sub>2</sub>O layers in the montmorillonite. This suggests that, in contrast to experiment 1, the sample chamber in experiment 2 lacked free liquid H<sub>2</sub>O and that the H<sub>2</sub>O pressure may be less than that of the liquid-vapor curve. Experiment 3 used air-dried montmorillonite without H<sub>2</sub>O as a starting material, and the sample chamber remained unsealed during the course of the experiment. The diffraction pattern of the starting air-dried montmorillonite shows interstratification of a hydrate with one H<sub>2</sub>O layer and an anhydrate.

## RESULTS

Results show that only the  $d_{001}$  of montmorillonite has enough intensity to be detected throughout the heating experiments. X-ray counts are plotted vs. energy in Figure 2, and peaks are labeled as  $d$  values, in ångströms, using experimental parameters and calibration factors in Tables 1–3.

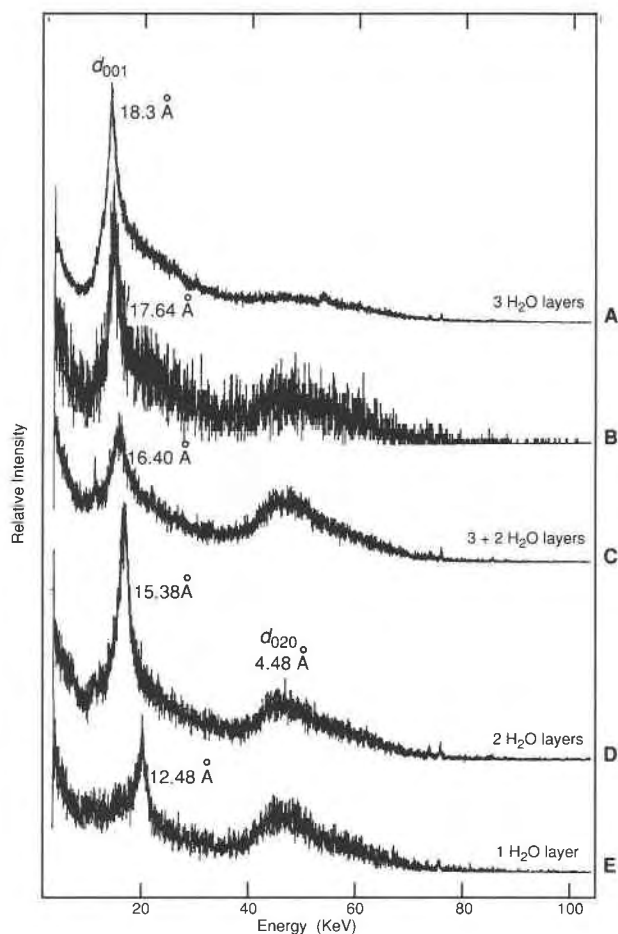

Fig. 2. Example of raw data from experiment 1 showing the dehydration of montmorillonite monitored by synchrotron X-rays: starting Na-saturated montmorillonite at (a) 25, (b) 313, (c) 358, (d) 385, and (e) 508 °C.

The results from experiments 1, 2, and 3, respectively, are summarized in Tables 1, 2, and 3 and Figures 3, 4, and 5. The average interlayer spacing for four hydration states—dehydrated montmorillonite (9.8–10.0 Å) and hydrates with one, two, and three H<sub>2</sub>O layers (respectively, 12.4, 15.6, and 18.75 Å; Sato et al., 1992)—are also shown in the figures for comparison. Our data show that the basal diffraction of montmorillonite corresponds closely at most experimental conditions with these hydration states and, at some conditions, with the intermediate states similar to those found under controlled humidity experiments (Moore and Hower, 1986; Sato et al., 1992). The intermediate states may result from the interstratification of two (or more) hydrate states (MacEwan and Wilson, 1980; Moore and Hower, 1986). No attempt was made to quantify the distribution of the two hydration states or the ordering of the interstratified structure because of the lack of higher-order basal diffractions and superlattice diffractions. The reported population was based on a semiquantitative estimation of the amount of end-member hydrate within the interstratified

**TABLE 1.** Experimental data for the dehydration of smectite under H<sub>2</sub>O pressure (experiment 1)

No.	<i>t</i> (h)	<i>T</i> (°C)	<i>P</i> (bars)	<i>d</i> <sub>001</sub> (keV)	<i>d</i> <sub>001</sub> (Å)
1	0.00	25	1.0	12.90	18.30
2	1.58	44	1.1	12.72	18.56
4	3.33	90	1.7	12.85	18.38
9	10.88	165	6.9	13.18	17.92
10	13.32	161	6.3	13.16	17.95
10a	13.77	182	10.4	13.16	17.94
11	13.83	181	10.1	13.20	17.89
11a	13.85	200	15.3	13.19	17.90
12	13.93	203	16.3	13.21	17.88
13	15.92	225	25.2	13.21	17.87
14	16.17	256	43.4	13.29	17.77
16	16.67	280	54.1	13.27	17.80
17	16.77	313	1096	13.38	17.65
18	16.83	335	1468	13.60	17.36
19	17.23	358	1855	14.40	16.40
19a	18.28	385	2309	15.35	15.38
20	18.35	385	2309	15.35	15.38
20a	18.40	293	760	15.35	15.38
20b	18.50	200	15.3	15.35	15.38
21	18.55	200	15.3	15.27	15.46
21a	18.63	200	15.3	15.35	15.38
22	18.73	88	1.6	14.27	16.55
24	18.87	45	1.1	13.33	17.71
25	18.98	40	1.1	13.30	17.75
25a	19.05	330	1800	13.30	17.75
26	19.12	385	2850	15.40	15.33
26a	19.30	385	2850	15.37	15.36
27	19.38	405	3100	15.58	15.16
27a	19.40	422	3350	15.37	15.36
29	19.68	453	390	15.32	15.42
30	19.70	477	4200	15.39	15.35
30a	19.73	485	4400	15.65	15.09
30b	19.75	500	4550	18.80	12.56
31	19.98	508	4560	18.92	12.48
32	20.25	525	5000	no peak	
33	20.28	493	4800	no peak	
33a	20.45	488	4500	no peak	
33b	20.47	465	4100	no peak	
33c	20.50	465	4100	no peak	
34	20.93	460	4050	24.20	9.76
35	21.02	500	4550	24.35	9.70
36	21.17	523	5000	24.49	9.64
37	21.32	553	5350	no peak	

Note: the times given indicate the experimental time from the beginning of heating.

**TABLE 2.** Experimental data for the dehydration of H<sub>2</sub>O-undersaturated smectite in a closed system (experiment 2)

No.	<i>t</i> (h)	<i>T</i> (°C)	<i>P</i> (bars)	<i>d</i> <sub>001</sub> (keV)	<i>d</i> <sub>001</sub> (Å)
1	0.00	25	1.03	15.88	14.87
1a	0.05	60	1.2	15.80	14.94
2	0.20	88	1.6	19.02	12.41
3	0.32	80	1.5	19.95	11.84
4	0.48	80	1.5	18.99	12.43
4a	0.62	57	1.2	19.00	12.43
5	12.70	31	1.0	19.10	12.36
6	12.83	29	1.0	19.10	12.36
7	12.95	80	1.5	19.18	12.31
17	13.33	195	13.8	20.01	11.80
18	13.38	215	20.7	19.58	12.06
19	13.42	240	33.0	24.47	9.65
20	13.57	247	37.3	24.39	9.68
23	13.90	212	19.6	24.41	9.67
24	14.05	189	12.1	24.30	9.72
25	16.88	33	1.05	24.38	9.69

Note: the times given indicate the experimental time from the beginning of heating.

**TABLE 3.** Experimental data for the dehydration of air-dried smectite in an open system (experiment 3)

No.	<i>t</i> (h)	<i>T</i> (°C)	<i>P</i> (bars)	<i>d</i> <sub>001</sub> (keV)	<i>d</i> <sub>001</sub> (Å)
4	0	25	1	20.00	11.81
5	0.20	85	1	20.13	11.73
8	0.33	110	1	20.15	11.72
9	0.58	124	1	20.40	11.57
10	0.85	122	1	24.23	9.75
11	1.05	118	1	24.20	9.76
26	2.43	380	1	24.26	9.73
36	3.08	575	1	24.02	9.83
40	13.08	83	1	24.40	9.68
47	13.78	730	1	24.31	9.71
48	14.07	777	1	no peak	

Note: the times given indicate the experimental time from the beginning of heating.

hydrate, assuming a simple proportion to the interlayer spacing of the end-member hydrate.

The hydrate with three H<sub>2</sub>O layers (18.56 Å) in experiment 1 first dehydrated mainly to an interstratified hydrate with three and two H<sub>2</sub>O layers (17.85 Å), with about 20% of hydrates with two H<sub>2</sub>O layers at temperatures and H<sub>2</sub>O pressures between 44 °C and 1.1 bars and 163 °C and 6.2 bars for about 10 h (Fig. 3). The interstratified hydrate was stable with slight dehydration (from 17.85 to 17.65 Å) over a wide temperature and pressure interval, from 163 °C and 6.2 bars to 313 °C and 1096 bars for 6 h. The major dehydration occurred at a temperature and pressure interval between 313 °C and 1096 bars and 385 °C and 2850 bars. The interlayer spacing decreased significantly from 17.65 to 17.36 Å as the temperature was raised from 313 to 335 °C in 3.6 min. The peak continued to shift from 17.36 to 16.40 Å as the temperature was raised from 335 to 358 °C in 24 min and to 15.35 Å (*d* values for the hydrate with two H<sub>2</sub>O layers) as the temperature was raised to 385 °C in 19 min. However, that does not mean that the dehydration reaction kinetically takes tens of minutes. It is difficult to discern the dehydration rate from the heating rate on the basis of these data because the equilibrium dehydration occurs over a temperature interval caused by the increase of pressure during the dehydration (see the discussion, below). Within this interval, the *d* values are determined by temperature rather than by time. The second heating cycle of the experiment (data nos. 25a and 26 in Table 1) shows that the dehydration of the hydrate with three H<sub>2</sub>O layers to one with two H<sub>2</sub>O layers (*d* values from 17.75 to 15.33 Å) occurs as the temperature increases directly from 330 to 385 °C in 4.2 min.

After the complete dehydration of montmorillonite to two H<sub>2</sub>O layers at 385 °C, the sample was cooled slowly to 200 °C in 9 min and held at 200 °C and 14.3 bars for 8 min. The results show no significant rehydration of the sample. The major rehydration occurred as the sample cooled further within the temperature interval 200 to 40 °C. The basal spacing increased rapidly to 16.55 Å at 88 °C within 6 min and to 17.75 Å at 40 °C within 9 min. The results show

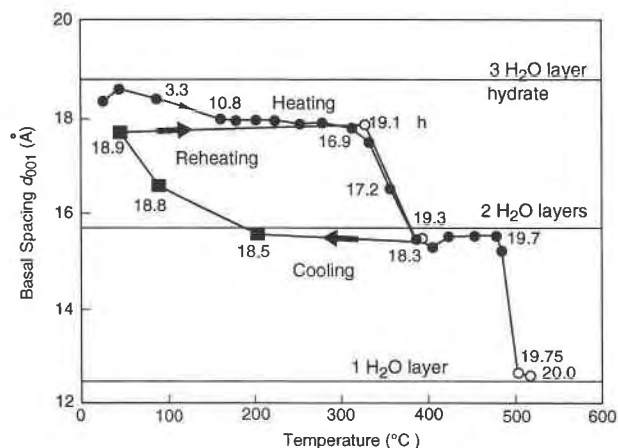

Fig. 3. Changes in  $d_{001}$  during dehydration reactions of montmorillonite hydrate with three  $\text{H}_2\text{O}$  layers (experiment 1). The symbols indicate  $d_{001}$  values of montmorillonite at each temperature measured at the time from the beginning of the experiment (shown as numbers next to each symbol, in hours). Pressures begin at  $\text{H}_2\text{O}$ -vapor pressure up to  $210^\circ\text{C}$  then rapidly increase to 1.5 kbar at  $335^\circ\text{C}$  and 4.55 kbar at  $500^\circ\text{C}$  (see Table 1 for details). The solid circles indicate heating, solid squares indicate cooling, and open circles indicate reheating. The solid curves are paths connecting data points. Arrows indicate the direction of heating or cooling.

hysteresis behavior during the dehydration and rehydration between hydrates with three and two  $\text{H}_2\text{O}$  layers. Reheating of the sample to  $330^\circ\text{C}$  for 4 min did not dehydrate it. The major dehydration occurred at a temperature interval similar to that observed during the first heating cycle. Note that no data were taken within the temperature interval  $330\text{--}385^\circ\text{C}$  and that it took  $<5$  min to dehydrate the montmorillonite from a hydrate with three  $\text{H}_2\text{O}$  layers to one with two  $\text{H}_2\text{O}$  layers. The two-layer hydrate was stable in the temperature range  $385^\circ\text{C}$  to  $477^\circ\text{C}$  and 4200 bars, and the dehydration of the two-layer to one-layer hydrate started at  $477^\circ\text{C}$  and was completed at  $488^\circ\text{C}$  and 4500 bars in  $<4$  min. With a further increase of temperature, the diffraction peaks disappeared between  $508^\circ\text{C}$  and 4560 bars and  $525^\circ\text{C}$  and 5000 bars within 6 min. This occurred before the dehydration of the last  $\text{H}_2\text{O}$  layer of montmorillonite at high  $\text{H}_2\text{O}$  pressure. This can be interpreted as decomposition or melting. The temperature at which the montmorillonite peak disappeared is consistent with the melting curve of montmorillonite in the presence of  $\text{H}_2\text{O}$  extrapolated from the lower pressure data of Koster van Groos and Guggenheim (1987b). The phase relationships of dehydration and the melting of montmorillonite with different hydration states are discussed in the next section. A weak dehydrated montmorillonite peak ( $9.75 \text{ \AA}$ ) appeared as the temperature cooled to  $460^\circ\text{C}$  and 4050 bars, indicating the crystallization of the montmorillonite melt.

Experiment 2 used Na-saturated montmorillonite that had an interlayer spacing close to the hydrate with two  $\text{H}_2\text{O}$  layers, with about 20% of the hydrate with one  $\text{H}_2\text{O}$

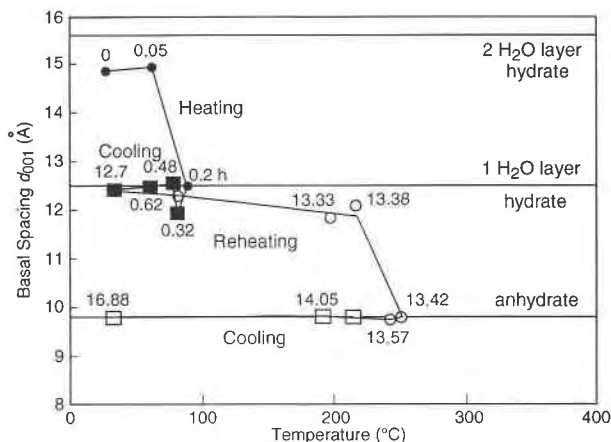

Fig. 4. Changes in  $d_{001}$  during dehydration reactions of montmorillonite hydrate with two  $\text{H}_2\text{O}$  layers (experiment 2). The pressure varies from vapor pressure to 37 bars at  $247^\circ\text{C}$  (Table 2). Open squares indicate second-cycle cooling; other symbols are similar to those in Fig. 3.

layer (Fig. 4). The results show that the dehydration of the two-layer to the one-layer hydrate occurred between  $60$  and  $88^\circ\text{C}$  in  $<9$  min. The sample was then cooled to  $30^\circ\text{C}$  for about 3 h, and no significant rehydration was observed. The hydrate with one layer of  $\text{H}_2\text{O}$  was completely dehydrated between  $215^\circ\text{C}$  and 20.7 bars and  $240^\circ\text{C}$  and 33 bars within 4 min during the reheating of the sample. Cooling of the dehydrated sample to  $33^\circ\text{C}$  for 3 h showed no rehydration.

Experiment 3 used the starting air-dried montmorillonite with interlayer spacings composed of about 75% of the one  $\text{H}_2\text{O}$  layer and 25% without interlayer  $\text{H}_2\text{O}$  (Fig. 5). With increasing temperature, no significant dehydration occurred until the temperature was raised to about

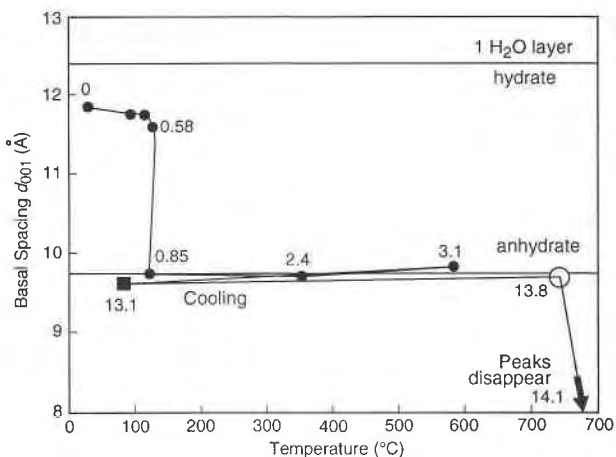

Fig. 5. Changes in  $d_{001}$  during dehydration reactions of montmorillonite hydrate with one  $\text{H}_2\text{O}$  layer using an air-dried sample (experiment 3). Total pressures throughout the experiments are near 1 bar. Symbols are the same as those in Fig. 3.

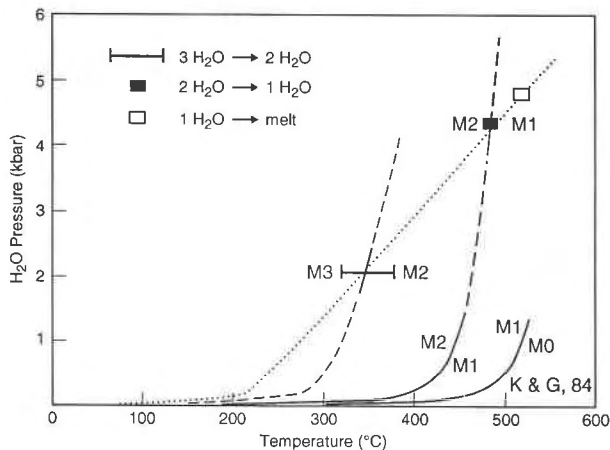

Fig. 6. Montmorillonite dehydration as a function of temperature and  $\text{H}_2\text{O}$  pressure. Dashed curves show the interpreted  $P$ - $T$  phase boundaries between hydrates. The dotted line indicates the  $P$ - $T$  path of experiment 1 estimated from the equation of state of  $\text{H}_2\text{O}$  without considering the pressure increase due to the dehydration reactions. K & G, 84 represents the first and second dehydration (solid curves) of Na-saturated montmorillonite determined by Koster van Groos and Guggenheim (1984) using the DTA method. M0, M1, M2, and M3, respectively, represent smectite hydrates with zero, one, two, and three  $\text{H}_2\text{O}$  layers. The bracket indicates the temperature interval of dehydration from 17.65 to 15.38 Å.

118 °C. Our data also reveal some kinetic information that shows that the time for dehydration was <16 min, although the minimum amount of time required for complete dehydration was not determined. The interlayer spacing of anhydrous montmorillonite remained nearly constant up to 730 °C. The basal spacing diffraction disappeared, probably because of the dehydroxylation (removal of OH) of montmorillonite at temperatures between 730 and 777 °C (Bish and Duffy, 1990). During the course of heating, the sample was cooled once from 575 to 83 °C within 25 min and then maintained at this temperature for 10 h. No rehydration was observed during the cooling.

## DISCUSSION

Montmorillonite with hydrate with three  $\text{H}_2\text{O}$  layers observed in this study at temperatures up to 350 °C was not found by Colten (1986), who showed that montmorillonite with hydrate with two  $\text{H}_2\text{O}$  layers ( $d_{001} = 15.51$ – $15.72$  Å) in 1- and 5- $M$  NaCl solutions is stable at temperatures ranging from 50 to 200 °C at  $\text{H}_2\text{O}$  pressures up to 456 bars. Although the  $\text{H}_2\text{O}$  pressures up to 215 °C (following the liquid-vapor curve of  $\text{H}_2\text{O}$ ) in experiment 1 are lower than those of Colten's experiments, the observation of hydrate with three  $\text{H}_2\text{O}$  layers at higher  $\text{H}_2\text{O}$  pressures between 215 °C and 20 bars and 313 °C and 1096 bars indicates that hydrate with three  $\text{H}_2\text{O}$  layers may also be stable at temperatures and pressures similar to those of Colten (1986). We believe that the discrepancy between these two studies can be attributed to the difference in solution salinity or  $\text{H}_2\text{O}$  activity, which can sig-

nificantly affect the stability of interlayer  $\text{H}_2\text{O}$  (Posner and Quirk, 1964; Koster van Groos and Guggenheim, 1987a). This, however, is less likely attributed to the effect of temperature, since the hydrate with three  $\text{H}_2\text{O}$  layers should occur at lower temperatures than the hydrate with two  $\text{H}_2\text{O}$  layers, or to the difference in the charge location of starting montmorillonite (Sato et al., 1992), since both Cheto and SWy-1 montmorillonite samples are mainly octahedrally charged. Further study on the effect of cations and salinity on the stability of different hydration states at elevated temperatures and pressures is required to resolve this discrepancy.

The real-time X-ray diffraction also provides information on the dehydration rate of the interlayer  $\text{H}_2\text{O}$  of montmorillonite. Our results show that the dehydration of the hydrate with two  $\text{H}_2\text{O}$  layers to a hydrate with one or of a hydrate with one  $\text{H}_2\text{O}$  layer to an anhydrate proceeds over a small temperature interval and that the rates are fast, on the order of minutes. This is consistent with the previous observations that the reaction is fast enough to be detected by DTA. It is interesting to note, however, that a transition state (with  $d_{001}$  about 17.85 Å) between hydrates with three and two  $\text{H}_2\text{O}$  layers was observed to exist. It seems that the dehydration of three-layer to two-layer hydrate proceeds in two steps (Fig. 3): a partial dehydration (18.38 to 17.85 Å) within the temperature range 90–313 °C and a major dehydration (17.85 to 15.33 Å) within the range 313–385 °C. This may be attributed to the slow dehydration rate or to the thermodynamic nature of the reaction. We believe, on the basis of the nature of this reaction and the rate for dehydration of the hydrate with two  $\text{H}_2\text{O}$  layers, that the time period for which each temperature was held in our experiments is sufficient to achieve equilibrium. If this is the case, our results suggest that in the studied montmorillonite there are two different types of interlayer spacing with different expansion properties: about 20% of interlayer spacing is less stable with respect to the hydrate with three  $\text{H}_2\text{O}$  layers than are the rest of the spacings.

The hysteresis behavior of the dehydration-rehydration process suggests that the rehydration rate of the hydrate with three  $\text{H}_2\text{O}$  layers is slower than that of the dehydration reaction and significantly increases when the condition is far from equilibrium at lower temperatures. This is consistent with the observations that, at controlled humidity, the rehydration of smectite proceeds rapidly at room temperature even though the smectite was previously heated to a temperature as high as 500 °C (Kawano and Tomita, 1991).

Our results and other previous data on the dehydration of interlayer  $\text{H}_2\text{O}$  in smectite show that the temperature of the reaction increases with increasing  $\text{H}_2\text{O}$  pressure (Fig. 6). According to the Clausius-Clapeyron equation, the positive slope of the  $P$ - $T$  curve indicates that the total volume of the reaction products (montmorillonite + free  $\text{H}_2\text{O}$ ) is larger than that of the reactants (montmorillonite with interlayer  $\text{H}_2\text{O}$ ) since the dehydration reaction is endothermic (Fyfe, 1973; Colten-Bradley, 1987). This in turn implies that the density of interlayer  $\text{H}_2\text{O}$  is higher

than that of free H<sub>2</sub>O. The temperature interval (313–385 °C) observed for major dehydration of the hydrate with three H<sub>2</sub>O layers may be due to the increase of H<sub>2</sub>O pressure caused by the dehydration reaction. As the temperature reaches the dehydration temperature, the dehydration of interlayer H<sub>2</sub>O into pore space causes an increase in H<sub>2</sub>O pressure that immediately stops the reaction until the temperature rises again; in this way, the pressure increases with increasing temperature following the univariant dehydration curve until all three H<sub>2</sub>O hydrate layers are dehydrated, then the *P-T* path leaves the reaction curve as temperature increases further. The interpretation is consistent with the data, which show that it takes much more time for the hydrate with three H<sub>2</sub>O layers to dehydrate to a hydrate with two H<sub>2</sub>O layers if the heating temperature increases slowly (i.e., first heating cycle) than if temperature increases rapidly over the interval (i.e., second heating cycle). The temperature interval observed corresponds to the temperature range where the *P-T* path stays on the univariant curve. The small dehydration temperature interval observed for two-layer to one-layer hydrate suggests that the reaction *P-T* curve could be much steeper than that for three-layer to two-layer hydrate. The slopes of the dehydration curves have been considered in constructing the *P-T* phase diagram (Fig. 6).

Figure 6 compares the present study and previous studies on the *P-T* relationships of dehydration of montmorillonite and its end-member compounds. The *P-T* path of experiment 1 is shown as a dotted curve on the diagram. For simplicity, the pressure change due to the dehydration reactions as previously discussed is not shown; this pressure increase, calculated on the basis of the *P-T* slope, could be up to 3 kbar at 525 °C. Since the hydrate with three H<sub>2</sub>O layers is stable on the *P-T* path up to its dehydration temperature, the univariant dehydration curves (dashed lines in Fig. 6) for three to two layers, and, therefore, two to one layers and the one-layer hydrate to an anhydrate should be located at temperatures higher than this *P-T* path (dotted line in Fig. 6) until they intersect with the *P-T* path. Because the *P-T* path follows the liquid-vapor curve of H<sub>2</sub>O below 210 °C, the dehydration temperature of all three hydration states should be higher than the liquid-vapor curve of H<sub>2</sub>O at least up to 210 °C. The results are consistent with the dehydration curves interpreted from the DTA method (Koster van Groos and Guggenheim, 1984). However, our data are insufficient to confirm that the two DTA signals observed by Koster van Groos and Guggenheim (1984) indeed correspond to two of these three dehydration curves.

Our experimental data show that montmorillonite hydrate with one H<sub>2</sub>O layer decomposes before the dehydration of the last H<sub>2</sub>O occurs at high H<sub>2</sub>O pressure. The temperature of decomposition (525 °C) at 5 kbar is much lower than that (750 °C) found in experiment 3 with an air-dried sample and those of previous studies (Koster van Groos and Guggenheim, 1987a; van Olphen and Fripiat, 1979). This suggests that the decomposition of montmorillonite is more reasonably attributed to melting

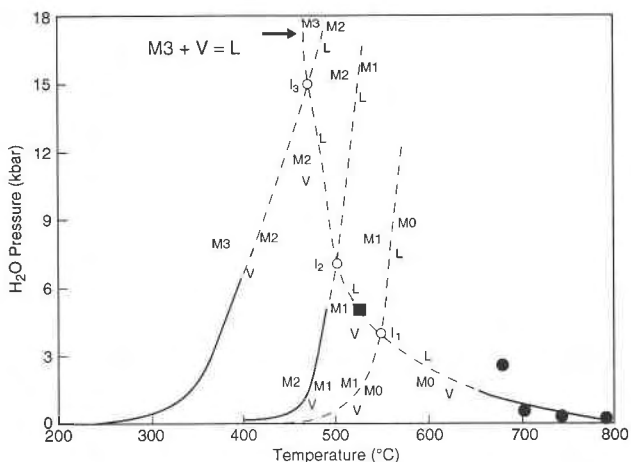

Fig. 7. Schematic diagram showing the phase relationships of montmorillonite hydrates at high H<sub>2</sub>O pressures. The melting points of montmorillonite hydrate with one H<sub>2</sub>O layer in the presence of fluid at pressures below 2.5 kbar (shown by solid circles) are from Koster van Groos and Guggenheim (1987b, p. 87–89). The solid square symbol at 525 °C and 5 ± 3 kbar indicates the melting point of smectite with one H<sub>2</sub>O layer observed in the present study. The heavy lines are dehydration curves from Fig. 6. Dashed curves are interpreted phase relationships. I<sub>1</sub>, I<sub>2</sub>, and I<sub>3</sub> are invariant points (small open circles), each of which involves four phases, two hydrates, one melt (L), and one fluid (V) (see text for explanation). The configuration of the four univariant curves around invariant points is constructed with the assumption that the solubility of H<sub>2</sub>O in the melt is higher than the amount of H<sub>2</sub>O released from montmorillonite hydrates. Otherwise a univariant curve, M1 + M0 = L, at temperatures lower than that for M1 = L + V is an alternative configuration for I<sub>1</sub>. Similar alternative configurations also exist for the invariant points I<sub>2</sub> and I<sub>3</sub>. M0 is montmorillonite anhydrate; M1, M2, and M3 are montmorillonite with different hydrates. Symbols are the same as those in Fig. 6.

than dehydroxylation because the dehydroxylation temperature normally increases with increasing H<sub>2</sub>O pressure (Bish and Duffy, 1990). Using high-pressure DTA up to 2.5 kbar, Koster van Groos and Guggenheim (1987b) showed that the melting temperature of SWy-1 montmorillonite in the presence of H<sub>2</sub>O significantly decreases with increasing H<sub>2</sub>O pressure. They also showed that montmorillonite in the presence of H<sub>2</sub>O metastably melts to a liquid phase with composition similar to montmorillonite. They interpreted the observed melting and dehydroxylation phase relationships as representing metastable equilibria because montmorillonite is not stable above ~480 °C at H<sub>2</sub>O pressure around 1 kbar (Roy and Roy, 1955) and the Al-rich liquid melt is metastable.

Figure 7 shows our proposed schematic diagram with only limited experimental data for the high-pressure phase relationships of montmorillonite. The phase relationships show three invariant points on a *P-T* diagram. Each of these three invariant points involves four phases: H<sub>2</sub>O-rich fluid, aluminosilicate melt, and two montmorillonite hydrates or an anhydrate. The diagram was constructed using phase relationships similar to those for the dehy-

droxylation and melting of hydrous minerals such as montmorillonite (Koster van Groos and Guggenheim, 1987b) or muscovite (Huang and Wyllie, 1973). The configuration of the univariant curves around the invariant points shown in Figure 7 is based on the assumption that the amounts of  $H_2O$  dissolved in the melt are higher than the amount released from montmorillonite. We believe this is probably true at the studied  $H_2O$  pressures (Koster van Groos and Guggenheim, 1987b). Our observations that montmorillonite hydrate with one  $H_2O$  layer had melted before the dehydration of the last  $H_2O$  occurred are generally consistent with the extrapolated melting curve of montmorillonite at low pressures (Koster van Groos and Guggenheim, 1987b). However, our data show that the melting of montmorillonite hydrate with one  $H_2O$  layer occurs at 5 kbar and 525 °C, which is lower than the extrapolation from the data point of Koster van Groos and Guggenheim at 2.46 kbar and 672 °C (Fig. 7). This suggests that our estimated pressure, which did not take the pressure increase due to montmorillonite dehydration into account, could be much lower than the actual total pressure. The phase relations also predict the existence of an invariant point involving montmorillonite hydrates with three and two  $H_2O$  layers at high pressure. The reliability of the proposed phase relationships depends on the stability of montmorillonite hydrates at high  $H_2O$  pressure, whereas the actual locations of the phase boundaries require further experimental determination. However, as with the interpretation of Koster van Groos and Guggenheim (1987b), this type of phase relationship could be metastable equilibria.

### GEOLOGICAL SIGNIFICANCE

The illitization of smectite during burial diagenesis of fine-grained sediments is one of the most important reactions that can influence the evolution of subsurface fluids in a sedimentary basin. The reaction releases a large quantity of  $H_2O$  into the pore space, affects the subsurface fluid flow, and may cause abnormal pressure in the sedimentary column (e.g., Koster van Groos and Guggenheim, 1989). Illitization does not occur if the pore fluid composition is not in the stability field of illite (e.g., Sass et al., 1987), such as in rock formations with very low K concentration either in the pore fluid or in solid minerals. Otherwise, illitization can occur at temperatures as low as 70 °C if reaction time (e.g., 300 m.y.) is sufficient (Środón and Eberl, 1984). In most natural environments, particularly in shales, pore fluid compositions tend to be buffered in the illite stability field (Huang, 1992), and illitization is mostly found to occur at 70–130 °C (Perry and Hower, 1972). Illitization can, therefore, be treated as a kinetic process (Huang et al., 1993), significantly different from smectite dehydration, which is mainly controlled by equilibrium.

The amount of  $H_2O$  released during illitization depends on the hydration states of the precursor smectite. Smectite hydrate with one or two  $H_2O$  layers has been widely used to model the dehydration of smectite-bearing

sediments (Burst, 1969; Perry and Hower, 1972; Bethke et al., 1988). Powers (1967), on the other hand, postulated the existence of a hydrate with four  $H_2O$  layers. The present study, however, found that montmorillonite hydrate with three  $H_2O$  layers is stable at most *P-T* conditions found in sedimentary environments. Illitization of dehydrated smectite releases no  $H_2O$  into the pore space. Therefore, it is very important to know the dehydration temperatures of different smectite hydrates relative to the illitization temperature. This study confirms the study of Koster van Groos and Guggenheim (1984): temperatures for illitization of montmorillonite during burial diagenesis are much lower than those of the dehydration of montmorillonite under hydrostatic conditions. Colten-Bradley (1987) suggested that under differential stress the dehydration of smectite might occur at temperatures as low as the illitization temperature. The release of interlayer  $H_2O$  from smectite, in general, occurs upon illitization in spite of its high dehydration temperatures.

Our experiments in a closed system simulating a pressure compartment within the sedimentary column also qualitatively confirm that the dehydration of the interlayer  $H_2O$  of montmorillonite increases the total pressure within the compartment and therefore could significantly contribute to the formation of overpressure. The interlayer  $H_2O$  of smectite released along with illitization can play the same role as smectite dehydration.

During the deep burial of sediments, particularly in the subduction zone, hydrous minerals such as micas are considered major carriers of the near-surface  $H_2O$  that is able to enter the lower crust (Huang and Wyllie, 1973). Smectite containing a large quantity of interlayer  $H_2O$  is an ideal carrier of such  $H_2O$ . The present results show that in the absence of  $K^+$  ion and differential stress, montmorillonite hydrate with three  $H_2O$  layers (~30 wt%  $H_2O$ ) can be stable to 350 °C, and a hydrate with two  $H_2O$  layers (>20%  $H_2O$ ; Fu et al., 1990), to 480 °C. The amount of  $H_2O$  retained in montmorillonite interlayers is much larger than that in micas (~4.7 wt%), kaolinite (~13.8 wt%), or other hydrous minerals. Montmorillonite or other smectites, therefore, can be an important source of  $H_2O$  for metamorphism and magma generation deep in the crust if they can survive deterioration by other reactions such as illitization or dehydration due to differential stress. Montmorillonite-bearing sediments can escape illitization during deep burial if  $K^+$  is not available, such as within thick bentonite beds (Altaner et al., 1984), or if the burial rate is very rapid, such as in subduction zones (Koster van Groos and Guggenheim, 1987a, 1989). The formation of overpressure in fine-grained sediments during deep burial, when the fluid pressures tend to approach lithostatic pressure, may significantly lower the differential stress.

### ACKNOWLEDGMENTS

The authors are grateful to J.M. Longo, E.J. Novotny, D.R. Pevear, and P.J. Vrolijk, of the Exxon Production Research Company (EPR), for discussions and comments during the course of this work, and to M.K. Kroeger of EPR for supplying the purified Na-exchanged montmorillonite



sample. The authors also extend thanks to S.P. Altaner of the University of Illinois, V.A. Colten-Bradley of the U.S. Nuclear Regulatory Commission, and S. Guggenheim of the University of Illinois (Chicago) for critically reviewing and improving the manuscript. The synchrotron radiation experiments were carried out at the Cornell High Energy Synchrotron Source (CHESS).

### REFERENCES CITED

- Altaner, S.P., Whitney, G., Aronson, J.L., and Hower, J. (1984) A model for K-bentonite formation: Evidence from zoned K-bentonites in the distributed belt, Montana. *Geology*, 12, 412–415.
- Bethke, C.M., Harrison, W.J., Upson, C., and Altaner, S.P. (1988) Supercomputer analysis of sedimentary basins. *Science*, 239, 261–267.
- Bish, D.L., and Duffy, C.J. (1990) Thermometric analysis of minerals. In J.W. Stuchi, D.L. Bish, and F.A. Mumpton, Eds., *Thermal analysis in clay science*, p. 96–157. Clay Minerals Society Workshop Lectures, Boulder, Colorado.
- Burst, J.F. (1969) Diagenesis of Gulf Coast clayey sediments and its possible relation to petroleum migration. *American Association of Petroleum Geologists Bulletin*, 53, 73–93.
- Colten, V.A. (1986) Hydration states of montmorillonite in NaCl brines at elevated pressures and temperatures. *Clays and Clay Minerals*, 34, 385–389.
- Colten-Bradley, V.A. (1987) Role of pressure in smectite dehydration: Effects on geopressure and smectite-to-illite transformation. *American Association of Petroleum Geologists Bulletin*, 71, 1414–1427.
- Farmer, V.C., and Russell, J.D. (1971) Interlayer complexes in layer silicates: The structure of H<sub>2</sub>O in lamellar ionic solutions. *Transactions of the Faraday Society*, 67, 2737–2749.
- Fu, M.H., Zhang, Z.Z., and Low, P.F. (1990) Changes in the properties of a montmorillonite-H<sub>2</sub>O system during the adsorption and desorption of H<sub>2</sub>O: Hysteresis. *Clays and Clay Minerals*, 38, 485–492.
- Furnish, M.D., and Bassett, W.A. (1983) Investigation of the mechanism of the olivine-spinel transition in fayalite by synchrotron radiation. *Journal of Geophysical Research*, 88, 10333–10341.
- Fyfe, W.S. (1973) Dehydration reactions. *American Association of Petroleum Geologists Bulletin*, 57, 190–197.
- Hanshaw, B.B., and Bredehoeft, J.D. (1968) On the maintenance of anomalous fluid pressures. *Geological Society of America Bulletin*, 79, 1097–1106.
- Huang, W.L. (1992) Illitic clay formation during experimental diagenesis of arkoses. In D.W. Houseknecht and E.D. Pittman, Eds., *Origin, diagenesis, and petrophysics of clay minerals in sandstones*. Society of Economic Paleontology and Mineralogy Special Publication, 47, 49–63.
- Huang, W.L., and Wyllie, P.J. (1973) Muscovite dehydration and melting in the crust and subduction oceanic sediments. *Earth and Planetary Science Letters*, 18, 133–136.
- Huang, W.L., Longo, J.M., and Pevear, D.R. (1993) An experimentally derived kinetic model for smectite-to-illite conversion and its use as a geothermometer. *Clays and Clay Minerals*, 41, 162–177.
- Kawano, M., and Tomita, K. (1991) X-ray powder diffraction studies on the rehydration properties of beidellite. *Clays and Clay Minerals*, 39, 77–83.
- Khitarov, N.L., and Pugin, V.A. (1966) Behavior of montmorillonite under elevated temperatures and pressures. *Geochemistry International*, 3, 621–626.
- Koster van Groos, A., and Guggenheim, S. (1984) The effect of pressure on the dehydration of interlayer H<sub>2</sub>O in Na-montmorillonite (SWy-1). *American Mineralogist*, 69, 872–879.
- (1986) Dehydration of a K-exchanged montmorillonite at elevated pressures. *Clays and Clay Minerals*, 34, 281–286.
- (1987a) Dehydration of a Ca-Mg-exchanged montmorillonite (SWy-1) at elevated pressures. *American Mineralogist*, 72, 292–298.
- (1987b) High-pressure differential thermal analysis (HP-DTA) of the dehydroxylation of Na- and K-exchanged montmorillonite. *American Mineralogist*, 72, 1170–1175.
- (1989) Dehydroxylation of a Ca- and Mg-exchanged montmorillonite. *American Mineralogist*, 74, 627–636.
- MacEwan, D.M.C., and Wilson, M.J. (1980) Interlayer and intercalation complexes of clay minerals. In G.W. Brindley and G. Brown, Eds., *Crystal structure of clay minerals and their X-ray identification*, p. 197–248. Mineralogical Society, London.
- Moore, D.M., and Hower, J. (1986) Ordered interstratification of dehydrated and hydrated Na-montmorillonite. *Clays and Clay Minerals*, 34, 378–384.
- Perry, E.A., and Hower, J. (1972) Late-stage dehydration in deeply buried pelitic sediments. *American Association of Petroleum Geologists Bulletin*, 56, 2013–2021.
- Posner, A.M., and Quirk, J.P. (1964) Changes in basal spacing of montmorillonite in electrode solution. *Journal of Colloidal Science*, 19, 798–812.
- Powers, M.C. (1967) Fluid release mechanisms in compacting marine mudrocks and their importance in oil exploration. *American Association of Petroleum Geologists Bulletin*, 51, 1240–1254.
- Roy, D.M., and Roy, R. (1955) Synthesis and stability of minerals in the system MgO-Al<sub>2</sub>O<sub>3</sub>-SiO<sub>2</sub>-H<sub>2</sub>O. *American Mineralogist*, 40, 147–178.
- Sass, B.M., Rosenberg, P.E., and Kittrick, J.A. (1987) The stability of illite/smectite during diagenesis: An experimental study. *Geochimica et Cosmochimica Acta*, 51, 2103–2115.
- Sato, T., Watanabe, T., and Otsuka, R. (1992) Effect of layer charge, charge location, and energy change on expansion properties of dioctahedral montmorillonites. *Clays and Clay Minerals*, 40, 103–113.
- Shen, A.H., Bassett, W.A., and Chou, I.M. (1992) Hydrothermal studies in a diamond anvil cell: Pressure determination using the equation of state of H<sub>2</sub>O. In Y. Syono and M.H. Manghnani, Eds., *High pressure research: Application to Earth and planetary sciences*, p. 61–68. Terra Scientific, Washington, DC.
- Šrodón, J., and Eberl, D.D. (1984) Illite. In *Mineralogical Society of America Reviews in Mineralogy*, 13, 495–539.
- Steinfink, H., and Gebhart, J.E. (1962) Compression apparatus for powder X-ray diffractometry. *Review of Scientific Instruments*, 33, 542–544.
- Stone, R.L., and Rowland, R.A. (1955) DTA of kaolinite and montmorillonite under H<sub>2</sub>O vapor pressure up to six atmospheres. Third National Conference of the Clay Minerals Society, Houston, Texas, NAS-NRC, 39, 103–116.
- van Olphen, H., and Fripiat, J.J. (1979) *Data handbook for clay materials and other non-metallic minerals*, 346 p. Pergamon, Oxford, United Kingdom.

MANUSCRIPT RECEIVED APRIL 21, 1993

MANUSCRIPT ACCEPTED MARCH 1, 1994