

CHEMISTRY AND ORIGIN OF THE BRINES OF LAKE MAGADI, KENYA

HANS P. EUGSTER

Department of Earth and Planetary Sciences, The Johns Hopkins University, Baltimore, Maryland 21218

ABSTRACT

Rivers, springs and brines of the Lake Magadi, Kenya, basin in the Eastern Rift Valley have been analyzed for Na, K, SiO₂, Cl, CO₃, HCO₃, SO₄, F, Br and B. Na/Cl ratios are remarkably constant for all waters, except the most concentrated brines, and this indicates that the river waters may be the recharge for a hot ground water reservoir from which the springs are fed. The concentration factor from rivers to springs is 1 to 1000 and is probably achieved through evaporative concentration throughout the basin floor. During this process most of the total carbonate and potassium is lost, the former mainly by precipitation of alkaline earth carbonates, the latter probably through ion exchange. Fluoride and sulfate show straight evaporative concentration, because saturation in fluorite and gypsum does not occur in this calcium-poor environment.

The hot springs (up to 86°C) discharge saline alkaline waters into the lake, and their compositions and temperatures have remained constant for over 50 years. Individual springs differ greatly in concentration, temperature and carbonate-bicarbonate ratio. Good correlations are obtained by assuming the mixing of three water types: (1) dilute, cold, bicarbonate-rich river water, (2) saline, hot bicarbonate-rich ground water, (3) saline, cold, carbonate-chloride enriched surface brine. Mixing ratios differ greatly from spring to spring. The well-mixed ground water reservoir may be located at a depth of as much as 2 km. The surface brine seems to enter the hydrologic paths from near the south end of the lake.

Springs feed directly into lagoons, which act as preconcentration basins for the lake brines. Crystallization of trona (Na₂CO₃·NaHCO₃·2H₂O) leads to bicarbonate depletion and chloride enrichment in the brines. Saturation also occurs with respect to villiamite (NaF), mirabilite (Na₂SO₄·10 H₂O) and thermonatrite (Na₂CO₃·H₂O). Inflow and recirculation estimates lead to a time span of at least 6000 years for the accumulation of the trona now present in the lake. Yearly net accumulation amounts to about 0.3 cm trona.

The salient hydrological features of Magadi are generalized into a model salt lake. This lake forms in a tectonically active area in an arid to semiarid climate. Large vertical relief insures the presence of perennial rivers, but these rivers disappear underground before they reach the lake. The lake itself is fed by groups of springs, which derive from a ground water reservoir whose salinity and temperature depends upon the circulation pattern. Lake Magadi is pictured as a typical salt lake at the peak of its productivity.

INTRODUCTION

Measured in geologic time, salt lakes are ephemeral features of the earth's surface. Many can be found on almost every continent, but few of them will leave impressive records in the stratigraphic column. A notable exception is the Eocene Green River formation. And yet, the significance of salt lakes should not be measured by the thickness of their deposits, but by the fact that they are the products of an evaporative environment—a large section of the geologic record similarly formed in an evaporative environment if a somewhat less severe one. This includes many carbonate rocks, gypsum deposits, banded iron formations and cherts. We can improve our understanding of such deposits by studying evaporative processes wherever they occur. In modern closed basins we can monitor water compositions from dilute inflow to brines, with concentrations ranging over four orders of magnitude. Excellent examples of detailed studies of individual salt lakes are those of Jones (1965, 1966) on Deep Springs and other playas of the Great Basin, by Lerman (1967) on the Dead Sea, and by Hardie (1968) on Saline Valley, California.

In contemplating the larger picture, two problem areas emerge as being particularly significant: (1) What reasons lie behind the astounding compositional diversity of salt lakes, and (2) What are the inner workings of a generalized salt lake?

The first question is being dealt with elsewhere in this volume (Hardie and Eugster, 1970). It is to the second one

I would like to address myself in this paper—the search for a model which incorporates those features one would expect to be shared by salt lakes. Such generalizations must be based upon detailed understanding of a specific basin that can be called typical and on the knowledge accumulated from many other basins. For the type example I propose to use Lake Magadi in Kenya. It was initially chosen for detailed work because it is considered to be the best Recent equivalent of Eocene Lake Gosiute of Wyoming from which the trona beds of the Green River formation were deposited (Bradley and Eugster, 1969).

Lake Magadi, in the East Rift in Kenya, became known to geologists primarily through the work of Baker (1958, 1963) who mapped the area and provided detailed descriptions of its geology, mineralogy and geochemistry. He summarized the data on the hot springs and brines, based mainly on an unpublished Magadi Soda Company report of J. A. Stevens (1932), entitled "Lake Magadi and its alkaline springs." Baker also reviewed the theories which had been put forth to account for the lake and its brines and added his own interpretation. Accordingly, the lake owes its existence to its location in the lowest part of the Rift Valley where it acts as an evaporating pan for alkaline springs which are fed by heated ground water. The new data supplied in this report fully support this interpretation and help to clarify a number of interesting points.

HYDROGRAPHY

The location of Lake Magadi in the East Rift, as well as that of other Rift Valley lakes is shown in Figure 1. Talling

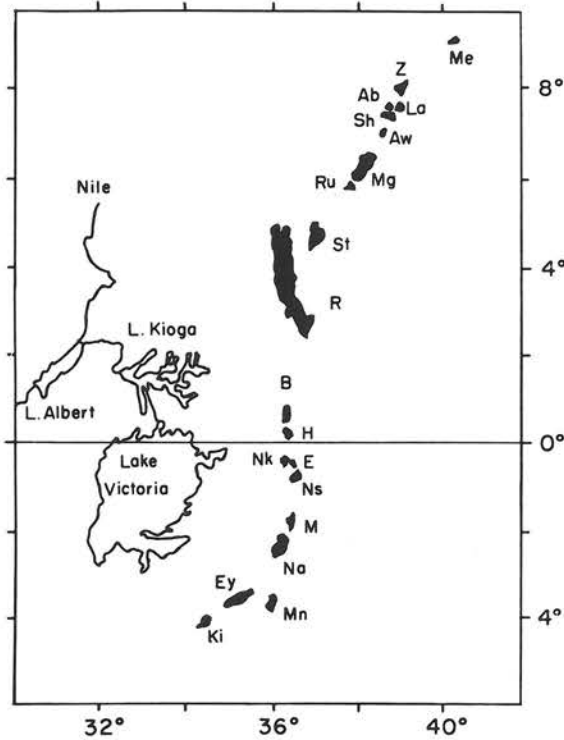

FIG. 1. Closed basin lakes in the East Rift in Ethiopia, Kenya, and Tanzania. From north to south: Me: Metahara, Z: Zwei, Ab: Abiata, La: Langanu, Sh: Shala, Aw: Awassa, Mg: Margherita, Ru: Ruspoli, St: Stephanie, R: Rudolph, Ba: Baringo, H: Hannington, Nk: Nakuru, E: Elmenteita, Ns: Naivasha, M: Magadi, Na: Natron, Mn: Manyara, Ey: Eyasi, Ki: Kitangiri. Lake Victoria is given for reference.

and Talling (1965) have reviewed the chemistry of these lake waters, and have found that most of them are predominantly sodium carbonate-bicarbonate brines, ranging from the very dilute to the most concentrated. Magadi contains the most concentrated brines and thus represents an end stage in the development of Rift Valley lakes. Lake Magadi has been saline for a long time, at least 10,000–20,000 years (Eugster, 1969), and it contains a very sizable deposit of trona ($\text{Na}_2\text{CO}_3 \cdot \text{NaHCO}_3 \cdot 2\text{H}_2\text{O}$), which covers an area of roughly 75 km² and is locally over 40 m thick. It lies in a narrow, bifurcated trough, formed during the Pleistocene by north-south faulting of the plateau trachyte flows which filled the Rift Valley floor. The basin was first occupied by a more dilute precursor of Lake Magadi with a lake level some 12–14 m above the present shore. The depositional record of this precursor is preserved in the High Magadi beds (for stratigraphic details, see Baker, 1958 and Eugster, 1969).

The hydrographic setting within the East Rift is given in Figure 2. Most of the perennial streams which feed into the Rift Valley are shown and the main sampling stations are also indicated. For the Lake Victoria water shed only those rivers are given which were sampled, and the Indian

Ocean water shed, originating in the eastern scarp, has been omitted entirely.

Lake Magadi lies at an elevation of 580 m, the Loita Hills rise to 2640 m, the Mau Escarpment to 3100 m and the Aberdare Range to 4000 m. It is obvious that the chief inflow into the Magadi basin must come from the Mau Escarpment, which acts as a very effective catchment for precipitation. The Loita Hills also contribute considerable amounts, mainly through the perennial streams Lengitoto (near 6, Fig. 2), Endosapia (8) and Oloibortoto (9). Some underground contribution may also come from the Naivasha basin to the north, which is fed principally from the Aberdare Range. No perennial streams reach the Magadi basin from the east scarp, which has no extensive highlands and hence is drier.

The Uaso Nyiro (10, Fig. 2) flows into Lake Natron, as it is separated from Magadi by a series of horsts. However, the streams descending from the Ngurumani scarp to the west of it (6, 7, 8 and 9, Fig. 2) disappear into the alluvial fans long before they reach the Uaso Nyiro. The latter must be a perched stream throughout its lower reaches, and has probably lost a large amount of water during its travel along the Rift Valley floor (some 80 km). Some of this loss is clearly by evaporation, but much probably disappears through the valley floor.

Ephemeral streams and runoff connected with the two rainy seasons also contribute water to the Magadi basin. In fact, the lake is usually flooded during the longer rainy season (March to April) and generally dries up again around June–July. This repeated flooding and drying causes the surface trona to be redissolved and recrystallized continuously, and the annual layering, commonly 2–5 cm in thickness, must be the result of both reprecipitation and

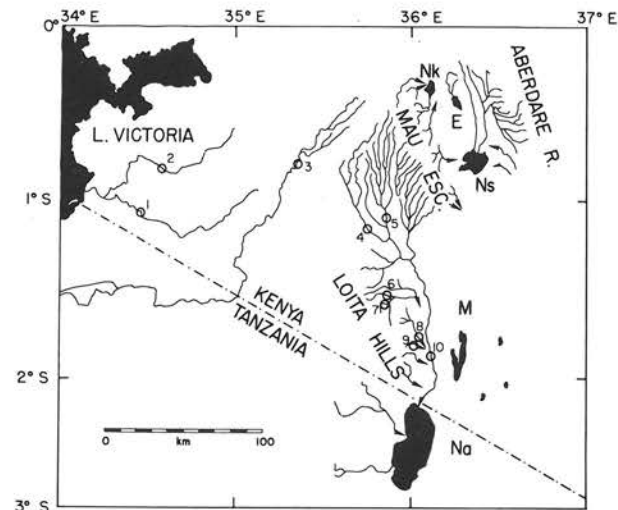

FIG. 2. Hydrography of the Lake Magadi water shed. Nk: Nakuru, E: Elmenteita, Ns: Naivasha, M: Magadi, Na: Natron. Only perennial streams are shown and arrows indicate approximate points of disappearance. Circled are stream sampling stations 1 to 10.

addition from the springs. Judging from the stream beds and deltas built up into the lake, the erosional force of some of the ephemeral water courses must be quite large. But in view of the short contact time, it is not likely that a significant portion of the solutes in the lake are contributed by runoff waters.

The principal springs and spring groups which feed into Lake Magadi are shown in Figure 3 (a) giving the numbers assigned by Baker (1958), (b) his temperatures in °C and (c) a mixing factor. As Baker (1958) has pointed out, there are a very large number of springs and seeps throughout the basin, and only the most obvious ones are given in Figure 3. Some of the stations refer to individual springs, while others refer to spring groups. Large diversity exists with respect to discharge, concentration, and temperature, but with no apparent correlation. However, chemistry and temperature of some major individual springs have changed little for at least fifty years (Eugster and Jones, 1968).

The springs generally flow into lagoons, bodies of water near the margins of the lake which remain open even during

the driest periods. Lagoon brines vary greatly in concentration and are intermediate between spring waters and lake brines. The lagoons clearly act as preconcentration basins.

The evaporites and lake brines have been discussed by Baker (1958). Four holes drilled in the lake penetrated trona beds of 4- to over 40-m thickness. The beds contain considerable amounts of brine, but the porosity is difficult to estimate at the surface because of solution and reprecipitation. Baker (1958) notes that the deeper trona is more massive. Judging from the porosity at Searles Lake (Haines, 1959), it is not unreasonable to assume an average ratio of trona:brine of 2:1 for the deposit as a whole.

SAMPLING AND COMPOSITION OF THE WATERS AND BRINES

Rivers, springs and lake brines were sampled in polyethylene bottles or double bags in the summers of 1966 and 1968. Temperature, pH and sodium ion activities were usually measured in the field. The waters were analyzed by Shirley Rettig of the U.S. Geological Survey, Washington,

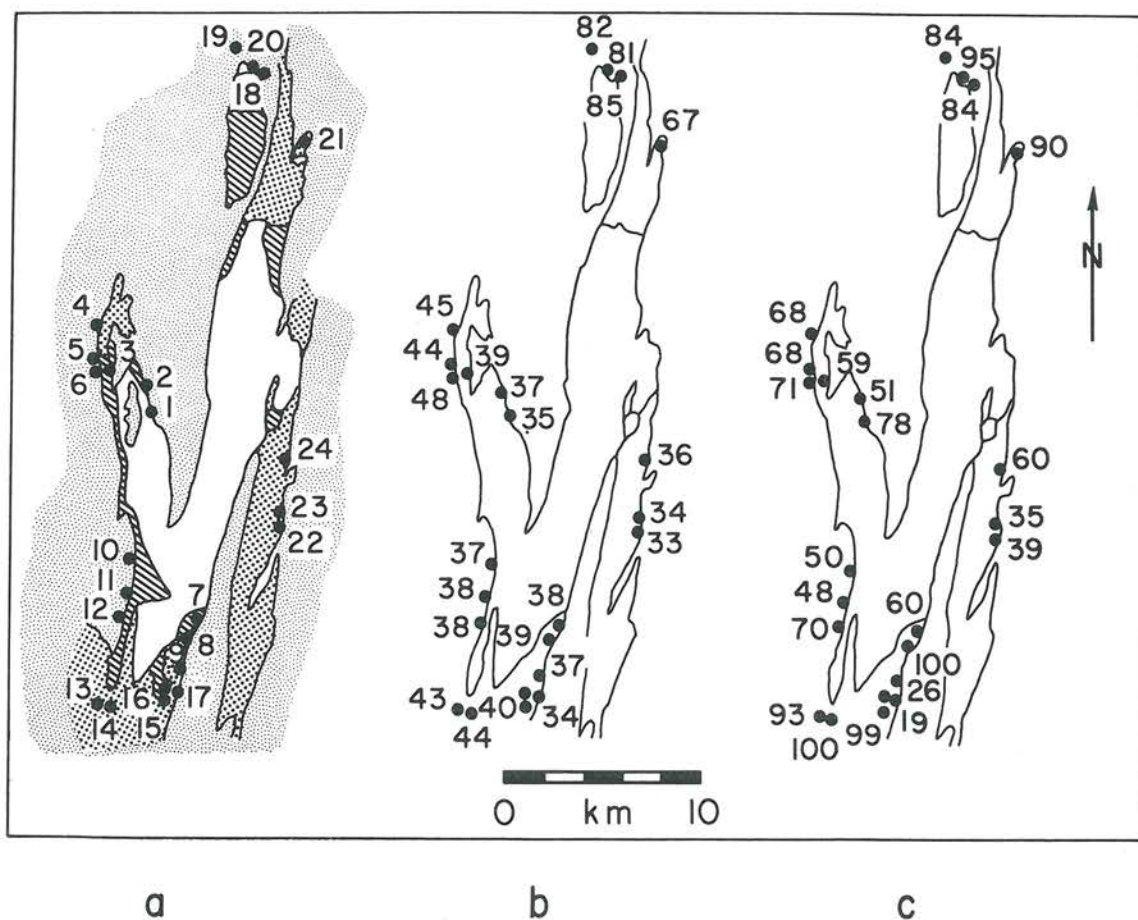

FIG. 3. Hot springs of Lake Magadi (large springs and spring groups only). a: Geology and Baker's (1958) numbers. Small dots: Alkali trachytes, large dots: Pleistocene sediments, ruled areas: lagoons, white: trona. b: spring temperatures, in °C. c: concentration factor, based on 100 for the most concentrated spring (B8 and B14).

TABLE 1. COMPOSITION OF DILUTE INFLOW, HOT SPRINGS, LAKE BRINES AND INTERSTITIAL BRINES IN MG/KG

#	T (°C)	Field pH	Lab pH	SiO ₂	Na	K	HCO ₃	CO ₃	SO ₄	Cl	F	Br	B	PO ₄	Dissolved Solids	Density
<i>Dilute Inflow</i>																
Migori ^a	24	8.1	7.98	40	16	4.9	100			4.0						
Gucha	21.5	7.2	7.59	30	5	1.9	36			1.7						
Nyangores	15	7.5	6.80	26	5	2.7	26			2.9						
Ewaso Ngiro	16.5	7.32		39	15	7.2	55			5.4						
Engare Narok	15	7.9	7.51	63	29	10	92			6.9						
Narosura	18	7.6		25	26	11	110			12						
Endiabirir	16	7.6	8.16	57	35	3.5	60			11						
Ongadie	18	8.2	8.35	43	83	11	227			42						
Endosapia		8.0	7.54	21	15	3.7	60			9.4						
Oloibortoto	19.5			20	9	2.4	53			5.8						
Uaso Nyiro	19.5		9.50	106	11,500	205	11,200	4,930		5,560						
M226			8.70	73	340	46	550	39	24	230	0.7		.55		1,020	
M15		9.38		95	27,400				300							
<i>Hot Springs</i>																
M14	81	9.05	9.05	90	12,600	239	10,500	4,080	147	5,950	162	70	8.8	11	30,400	1.006
M27	45.2	9.54		73	12,500				213							1.021
M45	44	8.82		104	7,930											1.009
M48	70.5	8.98	8.85	91	12,800	199	15,300	3,820	163	6,020	156	115	8.8	9.2	30,400	1.007
M62	82.5	9.13	8.98	85	11,100	199	15,400	3,700	179	5,240	144	158	8.3	10	26,800	1.005
M76	35	9.80		35	6,360				77							1.007
M77	37.3	9.52		61	3,980											1.004
M79	41	9.52		49	12,500				201							1.021
M84	37.2			70	6,540				142							1.009
M310	44		9.3	124	8,820	118	8,480	3,870	250	4,170	100	10	.67	44	21,700	1.020
Manyara	43.4	9.81	9.56	89	1,700	25	2,260	787		284						
<i>Lake Brines</i>																
M17.3	28		10.45	733	121,000	1,760	1,860	101,000	2,790	63,800	1,640	225	71	89	285,000	1.280
M17.4	26		10.45	895	113,000	1,950	1,060	101,000	1,270	64,400	1,640	219	72	88	290,000	1.279
M30A	31	11.05	10.55	959	125,000	1,990		93,900	3,620	84,900	1,530	303	102	70	319,000	1.325
M30B	26		10.55	782	127,000	1,770		109,000	1,750	72,000	1,150	258	87	53	305,000	1.299
M30C	27		10.55	1,100	131,000	1,850		97,200	4,800	77,800	1,540	294	95	92	306,000	1.295
M35	52	10.93	10.55	980	128,500	1,990		96,800	2,150	84,300	1,450	310	99	90		1.323
M36	43	10.60		817	116,000											1.288
M38	33	11.04		1,350												
M39	34	11.06	10.25	1,055	132,000	2,280		95,000	2,190	84,400	1,550	344	118	86	324,000	1.315
M40	36	10.98		1,440												
M43	41	10.61		878	113,000				1,910							1.278
M65	34	10.98	10.5	950	127,000	2,000		97,000	1,900	81,700	1,540	248	67	70	317,000	1.330
M68	36	10.11	9.5	538	110,000	1,530	4,730	85,900	1,035	50,700	1,540	221	62	66	247,000	1.239
M69	41	10.21	10.1	570	108,000	1,520	5,440	97,600	1,060	51,400	1,600	225	71	89	258,000	1.255
M80	27	9.50	9.25	345	64,000	1,050	20,000	47,400	585	27,200	772	248	44	49	145,000	1.140
M87A	26			1,057	132,000				2,610							1.292
M87B	26		10.52	802	111,000	1,470	3,250	93,700	1,570	58,300	1,350	216	74	51	267,000	1.258
M91	39		10.4	1,150	128,000			94,400	2,635	85,200	1,530	314	102	88	321,000	1.298
M218			10.45	1,010	124,000	1,510		104,000	1,780	64,100	1,400	219	76	56	293,000	1.288
M RLH			9.90	499	91,600	1,550	12,200	77,200	984	48,000	1,278	180	101	57	237,000	1.229
Natron A			9.97	155	62,700	1,080	11,500	58,100	4,420	18,300	966	73	59	130	154,000	1.154
Natron B			9.85	127	4,420	287	2,700	2,780	937	1,160	105	3.9	5.8	11	11,700	1.011
Nakuru				199	3,700											1.000
<i>Interstitial Brines</i>																
M14 C			9.80	165	43,900	1,080	26,500	23,900	1,150	27,800					135,000	1.115
M21 C			10.30	193	81,700	800	6,570	74,200	1,700	43,600					216,000	1.248
M22			9.65	230	79,200	760	14,700	58,500	1,390	46,700	840	200	32	123	197,000	1.179
M37 B			10.50	969	106,000	1,250	2,400	77,800	2,700	60,100					250,000	1.362
M40 A			10.85	1,350	119,000	1,990		82,000	2,410	80,600					285,000	1.427
M41			10.55	492	98,300	1,260	2,470	68,700	3,460	63,300					243,000	1.323
M42 C			10.45	1,000	93,100	1,480	6,290	74,300		61,400					245,000	1.300
M65 B			10.65	572	97,100	1,310		79,700	3,160	57,400					250,000	1.318
M88 A			10.80	1,330	120,000	1,920		97,900	2,310	79,000					305,000	1.430
M216			10.0	434	34,800	404	6,790	29,700	450	14,500	370	52	17	44	82,700	1.078
M313			10.1	537	41,100	584	5,290	38,400	520	16,100	460	53	20	45	101,000	1.095

^a The eleven rivers are listed as localities 1-10 in Figure 2, with Endiabirir and Ongadie lumped in station 7.

D.C. The methods used were essentially those of Rainwater and Thatcher (1960), modified, where necessary, under the guidance of Dr. Blair F. Jones. Silica values of some of these brines have been published (Jones *et al.*, 1968).

In addition to the new determinations, data on springs and brines contained in Baker (1958) have also been included in the diagrams. Where a direct crosscheck was possible between the two sets of data, (for a specific spring) the agreement is good. However, Talling and Talling (1965) have questioned some of the fluoride values reported in Baker (1958), and they suspect phosphate interference.

They also mention that some of the sulfate values based on barium precipitation may be too low. All new sulfate data are based on an ion exchange separation.

Guest and Stevens (1951) have determined the compositions of the Lake Natron rivers, springs and brines, and their data were also used. To put the Magadi-Natron area into the broader context of the other Rift Valley lakes, I have relied heavily on the compilation of Talling and Talling (1965), using primarily their own analyses.

The new chemical data are given in Table 1. The solutes are predominantly sodium, carbonate-bicarbonate and

chloride. Of the other constituents, only silica and fluoride reach unusually high values which can be accounted for readily. Concentrations cover a range of 1:20,000 and the data are therefore presented in a series of log-log plots. To simplify comparisons, all values are given as mg/kg.

SODIUM VERSUS CHLORIDE: THE WORKING HYPOTHESIS

Figure 4 gives the sodium and chloride values, and indicates a remarkable constancy of the Na/Cl ratio over the whole range, except for the most concentrated brines in which chloride is preferentially enriched. Understandably, the largest scatter occurs among inflow waters. Even though the sampling is very incomplete, there is no doubt that the rivers from the Mau Escarpment (even including those draining into Lake Victoria) and the Loita Hills could, upon 1000-fold evaporative concentration, yield the Magadi hot springs at least with respect to sodium and chloride. The springs themselves differ surprisingly in concentration (over a factor of 5), but the deviations from a fixed Na/Cl ratio are almost all within experimental error. Figure 5, a linear plot of the springs only, confirms this constancy. As mentioned earlier (see Fig. 3), no correlation is apparent between concentration, temperature and discharge, and some of the most concentrated springs (B 8, B 14, B 15, B 16, Fig. 3a) are not particularly hot and, inversely, the hottest ones (B 18, B 19) are not the most concentrated ones.

The lake brines plotted in Figure 4 include lagoon waters, surface brines, brines from the drill holes and brines interstitial to muds. Only a selection has been plotted to indicate

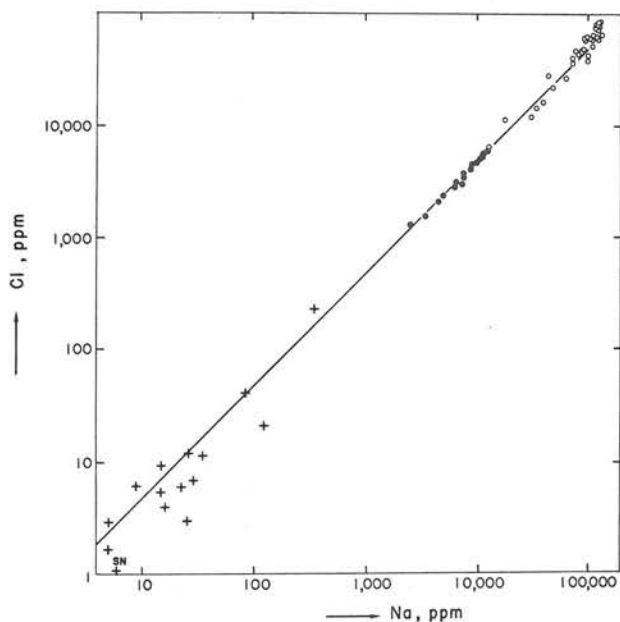

FIG. 4. Chloride versus sodium for Magadi waters. All values in mg/kg. Open circles: brines, full circles: hot springs, crosses: rivers, SN: Sierra Nevada perennial springs (from Feth *et al.* 1963).

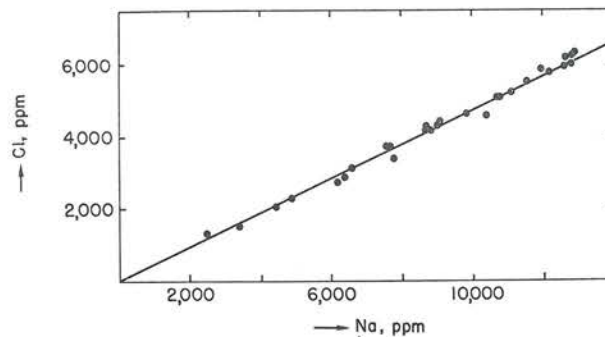

FIG. 5. Chloride versus sodium for Magadi hot springs, linear scale.

the diversity. The variations in Na/Cl are greater than for the springs; but the brines can readily be explained as the product of evaporative concentration of hot spring waters, in conjunction with the processes taking place at the lake surface, especially fractional crystallization and redissolution of trona and dilution of fractionated brines. Chloride enrichment in the brines saturated with trona is obvious. It sets in at about 107 g/kg and, in the most concentrated brines, reaches 130 g/kg sodium, with Cl varying between 50 and 85 g/kg. Ephemeral runoff can create chloride-rich waters by mixing with the most fractionated brines and chloride-poor waters by dissolving much trona. The details of these processes will be examined later.

The relationships exhibited in Figures 4 and 5 provide us with a working hypothesis. This hypothesis is founded on the assumption that sodium and chloride are reliable tracers during evaporative processes and on the following observations:

1. Hot springs provide the chief inflow into Lake Magadi, and therefore the evaporites (trona+brine) must have formed by evaporative concentration of average hot-spring water.
2. Hot springs have remarkably uniform Na/Cl ratios over a wide concentration range. There are, however, no apparent correlations between concentration, temperature, discharge rate and location of individual springs.
3. Hot spring compositions, where direct comparison is possible, have not changed significantly in over fifty years.
4. Rivers flowing into the Rift Valley from the Mau Escarpment and the Loita Hills have Na/Cl ratios similar to the springs, but are roughly 1000 times more dilute.
5. The Rift Valley is an area of active volcanism (Oldoinyo Lengai) and hence high heat flow. The floor of the valley is filled with Pleistocene trachyte lavas which have been extensively block-faulted.

The working hypothesis is illustrated by the schematic flow sheet shown in Figure 6. It assumes that the inflow feeds a large, well-mixed underground reservoir of hot, saline water, which in turn is the chief supply of the hot springs (path I). This is based on the constancy of spring compositions with time (for details see Eugster and Jones, 1968), and on the similarity of the Na/Cl ratios of river and

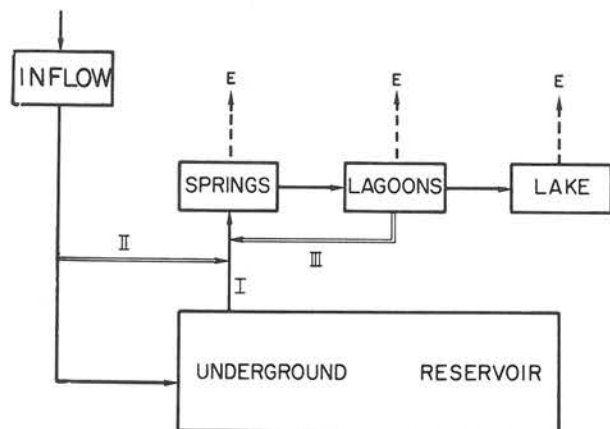

FIG. 6. Flow sheet for Lake Magadi hydrology. The underground reservoir is recharged from rivers through underground passages. It feeds, through path I, the hot springs, but some mixing occurs with inflow waters (path II). The mixing ratio is different for each spring but remains constant with time. Springs flow into lagoons which feed into the lake with evaporation (E) proceeding intensely along the surface paths. III is a recirculation path which will be discussed later.

hot spring waters. The diversity of total sodium and chloride concentration observed among the springs can then be explained by different degrees of mixing of the concentrated reservoir waters with the dilute inflow waters (path II). Mixing ratios must be constant over decades for any particular spring.

The remaining portion of the flow sheet, springs-lagoons-lake, is immediately observable in the field and is born out well by the Na/Cl ratios (see Fig. 4). Not accounted for, however, are two important aspects: (1) the 1000-fold gain in concentration from rivers to springs, and (2) the obvious lack of correlation between spring temperature and concentration. These questions must be dealt with before we can proceed with tests for the model.

The only effective way of increasing concentration is through evaporation. Some of this occurs already during flow in the river beds, perhaps to a factor 10, but it is most effective for rivers with the least amount of flow. During the dry season, the whole valley floor may act as an evaporating pan, and the bulk of the water is probably lost in this manner. This evaporation need not take place directly on the surface, and hence is not necessarily connected with efflorescent crusts, but can be accomplished through deep joints and cracks in a process similar to the evaporative pumping of Hsü and Siegenthaler (1969). We must remember that the valley floor contains very little sediment and that it has probably no well-defined, permanent water table. Evaporation rates are very high, and the evaporating area is very large (some 3000 km²).

The lack of correlation between spring temperature and concentration is more difficult to account for. The model assumes that the reservoir contains the most concentrated and hottest waters. However, a simple contamination

mechanism (path II) does not explain one obvious observation: the most concentrated springs are B 14, B 15, and B 16 with temperatures of 40–44°C (south end of the lake), while the hottest ones (B 18, B 19, B 20, north of Little Magadi), above 80°C, are not the most concentrated ones (Fig. 3). Perhaps we could account for the temperature differences by different cooling rates, but this is not borne out by qualitative estimates of discharge. B 20, the largest single spring in the basin, has a smaller discharge than the group of springs which make up B 14. The probable cause for the lack of correlation between temperature and concentration lies in recirculation and the resulting contamination of spring waters with lagoon brines (path III). This modification of the model will be discussed later. It must be emphasized here that none of the springs are near boiling, the highest temperature reported by Baker (1958) is 85°C, reconfirmed in 1966 to within 1/2°, and gas bubbles have not been observed in the discharge. It is possible, however, that some volcanic contributions to the reservoir occur; if so, they must be either small or have similar Na/Cl ratios.

We are now in a position to estimate the average sodium and chloride content of the reservoir. It is reasonable to choose, as representing the reservoir water, one of the hottest and most concentrated springs, M 48, with an Na content of 12,600 mg/kg and Cl of 6,020 mg/kg. A line through the origin and M 48 has been indicated in Figures 4 and 5. This line also goes through M 14 and B 20 (analyses of the large spring of 80.5–81°C referred to above), and through B 18 and B 19, the other very hot springs. The cooler, very concentrated springs from the south end are slightly richer in chloride, with an average Na/Cl ratio of 2.08, compared to the 2.13 value for M 48.

Using M 48 as a guide, we can calculate mixing ratios for all springs, indicating the reservoir contribution and assuming that the remainder is supplied by the dilute inflow. These mixing values are shown in Figure 3c. As we shall see later, contamination with surface brines plays a large part in some springs. The pathways and hydrostatic heads for individual springs must be very stable to account for the constancy of composition over half a century and the independence from seasonal and diurnal variations. Short-term changes were checked by measuring T, pH and pNA twice daily throughout June 1966 for three springs of the Fish Springs Lagoon (near B 24), and no systematic variations were detected.

Average values for model river, spring and brine compositions are suggested in Table 2, based in part upon the analyses of Table 1 and in part calculated from the concentration factors derived for sodium and chloride. Two brines are distinguished: one just at the point of trona saturation, the other representing the most concentrated Magadi brines. The behavior of the saturated brines is more complex because of crystallization and resolution processes, and these will be discussed in more detail in a later section. We can now proceed to test the working model with respect to the other anions and cations.

SODIUM VERSUS CARBONATE—BICARBONATE

Sodium is plotted against the sum of carbonate+bicarbonate in Figure 7. The rivers are all bicarbonate, the springs predominantly bicarbonate, and the most concentrated brines essentially carbonate. The most obvious implication of the data is, of course, a substantial loss of total carbonate during every step of concentration. The budget for all species, based on chloride concentration factors, is presented in Table 3. By far the greatest loss in total carbonate occurs between rivers and springs. Precipitation of Ca and Mg carbonates are most likely responsible for it. This is illustrated very clearly in the calculations of Garrels and Mackenzie (1967), and field evidence is supplied by the widespread occurrence of kunkar limestone in the Rift Valley floor (see Baker, 1958). Much carbonate is probably also precipitated underground. The loss between springs and lake brines is not through precipitation, since alkaline earths in the springs are low indeed, but probably through exchange with the atmosphere during evaporation. The springs have an approximate P_{CO_2} of $10^{-1.8}$ (for method of calculation see Garrels and Mackenzie, 1967), while the atmosphere is near $10^{-3.5}$. For all lagoon waters analyzed, this adjustment has already been accomplished. The loss of carbonate in the saturated brines is due to precipitation of trona, since trona removes 175 g ($HCO_3 + CO_3$) for every 100 g Na. The lower line indicates the progressive removal of carbonate, while the upper line, at 45° , is an evaporative concentration line. Both lines are for reference only.

The sodium versus total carbonate data are certainly in harmony with the working hypothesis. In fact, the deviations from simple evaporative concentration are precisely those one would expect. They are caused by alkaline earth precipitation and equilibration with the atmosphere. A similar conclusion emerges from an examination of the data on potassium.

SODIUM VERSUS POTASSIUM

Less data are available for potassium (see Fig. 8). Again, a very large loss must be assumed between rivers and springs, with 94.7 percent of the initial potassium removed

TABLE 2. MODEL COMPOSITIONS FOR RIVERS, SPRINGS, AND BRINES OF THE MAGADI BASIN, IN MG/KG

	River	Ground-water reservoir	First saturated brine	Final saturated brine	Sierra Nevada springs	4 times Sierra Nevada springs
C.F. ^a	1	600	5,000	8,500		
Cl	10	6,000	50,000	85,000	1.1	4.4
$HCO_3 + CO_3$	82	17,000	88,000	110,000	55	220
SO_4	(.27) ^b	160	1,300	2,300	2.4	9.6
F	(.27) ^b	160	1,300	1,500	.09	.36
Br	(.04) ^b	22	180	310		
B	(.01) ^b	7	60	100		
Na	21	12,800	107,000	130,000	6	24
K	6	200	1,650	2,000	1.6	6.4
SiO_2	36	90	750	1,280	25	100

^a C.F.: Concentration factor based on chloride.

^b Extrapolated values.

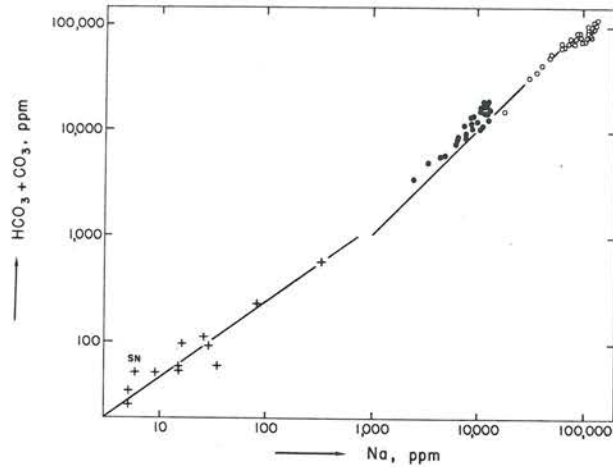

FIG. 7. Total carbonate versus sodium. Symbols as in Fig. 4. The line drawn through inflow waters is not at 45° , and hence implies progressive loss of ($HCO_3 + CO_3$) with increasing concentration.

(for the budget, see Table 3), presumably either through ion exchange on clay minerals during the underground transport, or through precipitation of potassium feldspar and other potassium-rich silicates. The paucity of potassium in the groundwater reservoir is due to this removal, rather than lack of supply from the rivers. Perhaps the long residence time implied by the 1000-fold concentration

TABLE 3. EVAPORATION BUDGETS, IN MG/KG, BASED ON CHLORIDE CONCENTRATION FACTORS (C.F.) OF TABLE 2

Ion	Balance	Average river	Groundwater reservoir	Brine at saturation	Final brine
C.F.		1	600	5,000	8,500
Na	calculated	21	12,800	107,000	178,500
	actual	21	12,800	105,000	130,000
	% loss	—	0	0	27
HCO_3	calculated	82	49,200	410,000	697,000
	actual	82	17,000	88,000	110,000
CO_3	% loss	—	65	78.5	84.6
K	calculated	6	3,600	30,000	51,000
	actual	6	200	1,650	2,000
	% loss	—	94.7	94.8	96.2
F	calculated	?	160	1,330	2,270
	actual	?	160	1,330	1,500
	% loss	?	0	0	34
SO_4	calculated	?	160	1,330	2,270
	actual	?	160	1,400	2,500
	% loss	?	0	0	0
Br	calculated	?	22	180	310
	actual	?	22	180	310
	% loss	?	0	0	0
B	calculated	?	7	58	99
	actual	?	7	60	100
	% loss	?	0	0	0
SiO_2	calculated	36	21,600	180,000	306,000
	actual	36	90	750	1,280
	% loss	—	99.58	99.58	99.58

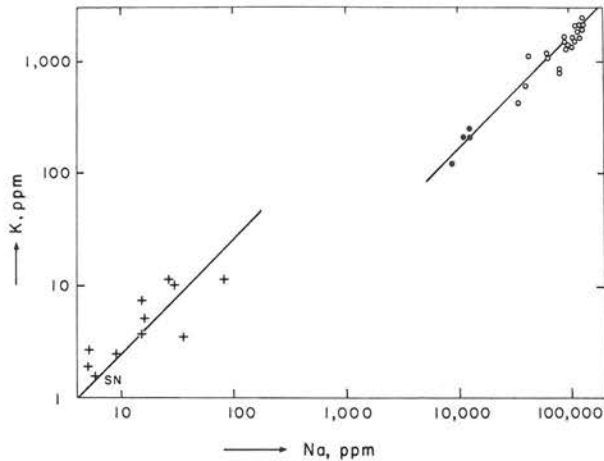

FIG. 8. Potassium versus sodium.
 Symbols as in Fig. 4.

factor is responsible for this very effective screening-out of potassium.

No loss of potassium occurs during evaporation in the lagoons, but crystallization of trona removes 27 percent of the remaining potassium, which is exactly the loss indicated for sodium during the same step. Hence, at these low levels of potassium concentration, trona does not seem to discriminate between sodium and potassium.

Judging from the few data available on other Rift Valley lakes, this behavior of potassium holds throughout.

CHLORIDE VERSUS FLUORIDE

Figure 9 summarizes the fluoride-chloride data. The scatter is considerably larger than for Na versus Cl, in part because of analytical uncertainties. Nonetheless, the fluoride content of the springs is sufficient to account for the unusually high fluoride values in the brines (see Table 3). Three lagoon points show very large deviations, but all three points are from the same lagoon: the Factory Scarp Lagoon, which receives effluent from the Magadi Soda Co. factory, and hence contamination is the probable cause. All other lagoons conform to the evaporative trend. The loss of 34 percent fluoride between the first and last brine (see Table 3) is a reflection of the villiaumite (NaF) precipitation. Baker (1958) has described mode of occurrence and properties of the villiaumite from Lake Magadi. Judging from Figure 8 saturation with respect to villiaumite is reached shortly after trona begins to crystallize.

If the fluoride content of the hot springs is sufficient to supply all of the fluoride in the lake, then the question remains whether the springs are unusually rich in fluoride to begin with. The few inflow data available indicate that they are not, and that their fluoride content is derived entirely from the rivers. In addition, the Sierra Nevada springs (Feth *et al.*, 1964) also lie near the evaporation path leading to the hot springs, hence no unusual source for fluoride need be found. Very significant, however, is the

implication that during concentration no fluoride is removed up to saturation with respect to villiaumite. This means that Ca was removed almost quantitatively through carbonate precipitation, before saturation with fluorite (CaF_2) was approached. Using solubility data for fluorite (Ellis and Mahon, 1964; Strübel, 1965, 1968) and some rough approximations, we can expect the springs at 80°C to contain less than 0.5 mg/kg Ca, and the brines at 20° less than 0.015 mg/kg Ca. Substantial amounts of fluorite (CaF_2) have been discovered in some Magadi cores (R. Sheppard, pers. commun.), but these may well have formed later by interaction of fluoride-rich brines with calcite-bearing muds.

The fluoride data support the model of evaporative concentration, and the unusually high fluoride accumulations are readily explained by the paucity of calcium. If this is indeed correct, we should expect most alkaline brines to be exceptionally rich in fluoride. Figure 9 shows that Magadi is actually poorer in fluoride than many other Rift Valley lakes. We should, however, keep in mind the warning of Talling and Talling (1965) with respect to analytical uncertainties.

CHLORIDE VERSUS SULFATE

According to the budget (Table 3) and Figure 10, sulfate follows straight evaporative concentration up to the most concentrated brines. This is possible only because the initial sulfate contribution is small, and because calcium has been effectively removed. The data show considerable scatter, even for the springs. Mirabilite has been observed to crystallize in substantial amounts from the concentrated

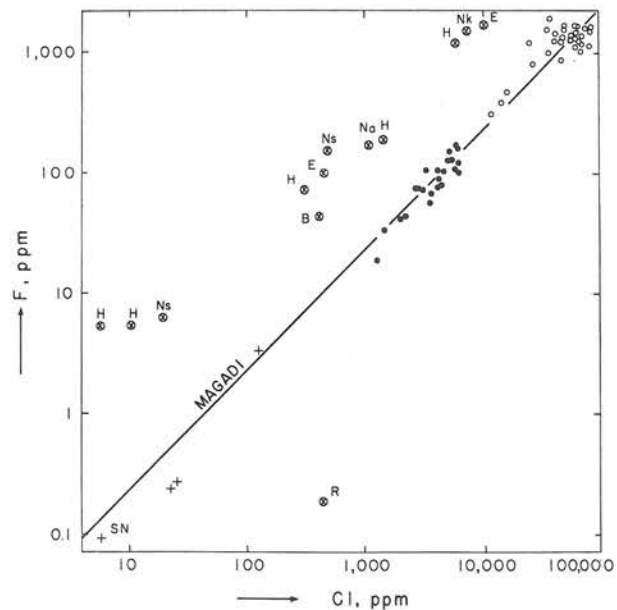

FIG. 9. Fluoride versus chloride. Symbols as in Fig. 4, except that the circled crosses refer to other Rift Valley lakes (for identification see Fig. 1).

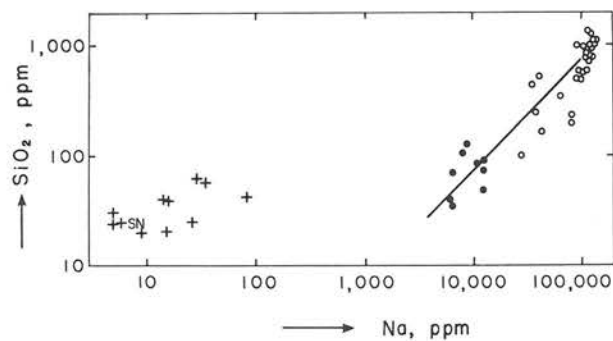

FIG. 13. Silica versus sodium. Symbols as in Fig. 4.

silica supplied by the rivers is lost during the underground transport, presumably through precipitation. On the other hand, the silica brought in by the hot springs remains in the brines during evaporative concentration. As Jones *et al.* (1967) pointed out, in the most concentrated brines there is a trend for still further silica enrichment which is caused by trona precipitation.

Other Rift Valley basins show similar patterns. Some of the dilute lake waters are poorer in silica than the rivers, probably because of silica removal by diatoms.

In summary, we can state that the concentrations of the individual species in river, spring and lake waters are compatible with the working hypothesis. Deviations from straight evaporative concentration exist, but they are precisely those which one would predict for the particular ion, based on our previous experience with mineral-water interactions.

COMPARISON WITH OTHER RIFT VALLEY WATERS

The Magadi basin is one of several similar basins in the East Rift Valley, and the question now poses itself with respect to the degree of communication between these basins. For Lake Magadi this is particularly important because of the vicinity of Lake Natron (30 km to the south), which covers a much larger area and has a lake level some 30 m higher than that of Magadi. There also exists the possibility of contributions from Lake Naivasha (100 km to the north), which is much higher in elevation (2030 m), surprisingly dilute, and receives large inflow from the Mau Escarpment and the Aberdare Range.

Data on sodium and chloride for most of the East Rift lakes from Ethiopia to Tanzania are given in Figure 14, together with the Magadi trend from Figures 4 and 5 (solid line). There is some scatter, though none of the waters are particularly rich in chloride (the dashed line is for a molar ratio of Na:Cl=1:1). In view of the constancy of the Na/Cl ratio for Magadi waters, it is not difficult to distinguish them from the waters of the neighbouring lakes Natron, Naivasha, Nakuru, Hannington and Baringo, all of which have distinctly higher Na/Cl ratios. The excep-

tions among the nearer lakes are Manyara and Elmenteita which fall close to the Magadi trend.

The deviations in chloride of the Magadi hot springs from the trend are usually less than 10 percent, and the Natron waters are poorer in chloride by almost 50 percent. Hence, from the chloride data alone we can state that the contamination with Natron waters must be less than 20 percent. This does not, of course, exclude the possibility that some Natron springs themselves stem from the same ground water reservoir which feeds Magadi.

The balance of the excess sodium in the lakes mentioned above is, in general, not accomplished by larger carbonate contents. This fact emerges from Figure 15, a comparison of the carbonate content of these lakes with the Magadi trend. The straight lines drawn in Figures 7 and 15 have no statistical significance, but are to aid comparison. To check the other anions, data on the East Rift lakes have also been plotted on Figures 9 and 10, and it seems quite clear that Magadi is comparatively poor in fluoride and sulfate, and the higher chloride values are compensated for by a deficiency in these two anions.

Further measurements are necessary to verify these conclusions, but it now appears that there is no large-scale mixing between adjacent basins and their reservoirs in the East Rift. The general character of the basin waters does not differ very greatly from each other, presumably because of similar watersheds, but the individual traits of a specific basin appear to be preserved throughout the cycle of evaporative concentration. In some cases this individuality may be based on a very few springs, but in the case of Magadi it

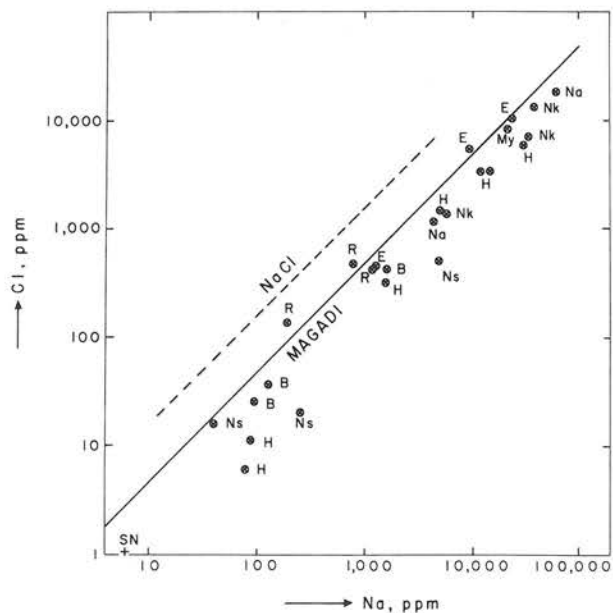

FIG. 14. Chloride versus sodium for East Rift Valley lakes. For key to abbreviations see Fig. 1. Solid line is for Magadi trend, from Fig. 4. Dashed line is for Na:Cl (equal molalities). Data from Talling and Talling (1965).

is true for all springs. They are all recognizable by comparatively high Cl and low F and SO_4 .

In most of the diagrams the average composition of the perennial Sierra Nevada springs (Feth *et al.*, 1964) has also been indicated; it fits very well indeed with the general East Rift trends, but it too is distinctly higher in sulfate and lower in chloride than Magadi. There is no question that, were it fed into a closed basin, it would produce a salt lake very similar to those of the East Rift Valley, in direct support of the conclusion reached by Garrels and MacKenzie (1967). This is a very important point. In the past, the unusual character of the Rift Valley lakes has been explained by the presence of unusual alkaline volcanics. However, the Sierra Nevada springs drain a terrane of granitic rocks, and their composition is chiefly governed by the plagioclase-kaolinite reaction (see Garrels and MacKenzie, 1967). Hence the principal solute composition of the Rift Valley lakes is determined not so much by the presence of volcanic rocks but rather by the virtual absence of sedimentary deposits (which would contribute much Ca and Cl) and of large sulfide accumulations (which would contribute much SO_4). The conclusion of lack of mixing between the Magadi and Natron basins has implications with respect to the possible role of the volcano Oldoinyo Lengai as source of the sodium carbonates in that part of the Rift Valley.

RECIRCULATION: REFINEMENT OF THE MODEL

Up to now we have assumed that all springs are fed directly from a ground water reservoir (path I), or are mixtures of reservoir water with dilute inflow (path II). There are some indications, however, that contamination with surface brines must play an important part (path II, Fig. 6). A close examination of Figures 5 and 7 reveals that the cool, concentrated springs (B 8, B 13-B 16) of the south

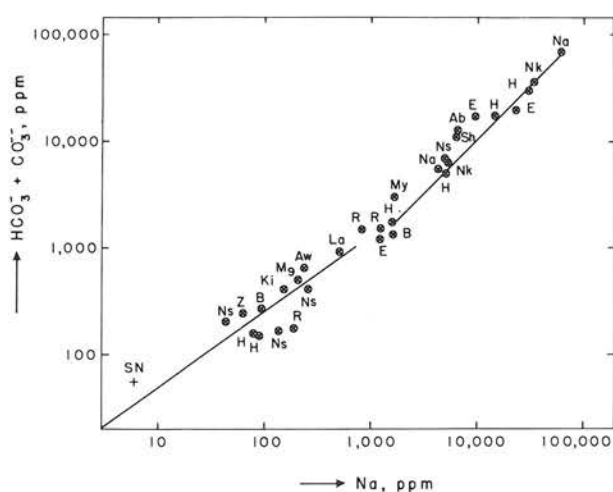

FIG. 15. Total carbonate versus sodium for East Rift Valley lakes. For key to abbreviations see Fig. 1. Solid lines are for Magadi, from Fig. 7.

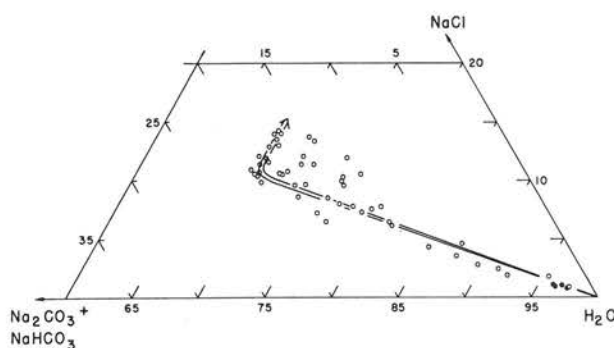

FIG. 16. Magadi hot springs and brines in the system $(\text{NaHCO}_3 + \text{Na}_2\text{CO}_3)\text{-NaCl-H}_2\text{O}$. Dots are hot springs, circles are lagoon, surface, interstitial and core hole brines. The path shown is the evaporative trend with NaCl enrichment due to the precipitation of trona.

end of the lake are slightly higher in chloride and lower in total carbonate than their hot counterparts in the north. The spring and brine compositions can be approximated very closely by the system $\text{NaHCO}_3\text{-Na}_2\text{CO}_3\text{-NaCl-H}_2\text{O}$, and the results are presented in Figures 16 and 17. In Figure 16, NaHCO_3 and Na_2CO_3 are lumped, but they are separated in Figure 17 where the anhydrous constituents (except, of course, NaF , Na_2SO_4 and the other minor components) have been recalculated to 100 percent.

Figure 16 shows the trends for evaporation, crystallization of trona and contamination of the saturated brines with dilute waters. The first saturated brines, at about 76 percent H_2O , lie nicely on the evaporative trend and they are fairly rich in bicarbonate. The majority of the brines, however, are depleted in bicarbonate and are saturated at about 69 percent H_2O . At that stage further depletion is not possible, and the crystallization path makes a sharp turn and follows the trona + thermonatrite + solution boundary towards NaCl enrichment. The compositions of some core hole brines, as well as some interstitial and lagoon brines, can be explained by assuming that they formed by

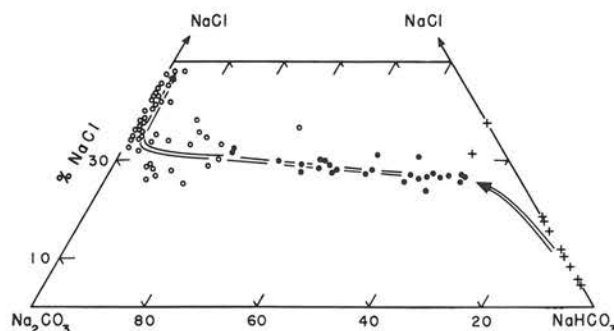

FIG. 17. Magadi waters plotted in the system $\text{NaHCO}_3\text{-Na}_2\text{CO}_3\text{-NaCl}$ (recalculated to 100%). Evaporative trend: arrows from right to left. The river waters cannot be plotted properly in this diagram (see footnote 1). Symbols as in Figure 4.

mixing of concentrated brines, enriched in NaCl, with dilute runoff or spring waters.

Figure 17 is a very instructive plot. Even though concentrations are not shown, the most dilute waters are on the right, the springs form the middle band, and the saturated brines are on the upper left. The scatter among the rivers is due to original differences, with the rivers descending from the Loita Hills contributing twice as much NaCl as the rivers originating in the Mau Escarpment. In fact it looks like the two main source areas contribute about equally to the Magadi basin. The movements up from the rivers towards the springs is due to removal of bicarbonate¹ and the pH change during the evaporative concentration, which shifts the bicarbonate-carbonate equilibrium towards carbonate.

The saturated brines show a trend similar to that of Figure 16, with the sharp bend again at the point of trona precipitation from bicarbonate-free brines (through addition of CO₂). However, the most remarkable feature of Figure 17 is the spread in carbonate-bicarbonate ratios of the springs. They vary anywhere from 20 to 65 percent NaHCO₃ of the total solids with a slight, concomitant change in NaCl. The hottest spring (B 18) is richest in bicarbonate while the most concentrated and relatively cool springs (B 15, B 16) are richest in carbonate and chloride. It is quite obvious that the simple mixing mechanism (path II, Fig. 6) cannot explain this observation, since the most concentrated springs would need to have the highest carbonate content as the dilute river waters only contain bicarbonate. The only obvious way in which we can produce springs with 50 percent Na₂CO₃ (B 15, B 16) is by contaminating the hot, bicarbonate-rich ground water with surface brines rich in carbonate, either from the lagoons or from interstitial brines deeper in the deposit. This explains simultaneously the high concentration, high carbonate content, and relatively low temperature of these springs.

To study this possibility further, the bicarbonate quotient, calculated as

$$\frac{\text{g NaHCO}_3}{\text{g NaHCO}_3 + \text{Na}_2\text{CO}_3},$$

has been plotted against the NaCl quotient

$$\frac{\text{g NaCl}}{\text{g NaCl} + \text{g NaHCO}_3 + \text{g Na}_2\text{CO}_3}$$

in Figure 18. Since there are some analytical problems connected with the carbonate-bicarbonate determinations in these brines, only the presumably internally consistent

¹ It is important to realize that in the rivers 80–95% of the bicarbonate is balanced by alkaline earth ions, and hence the river analyses cannot be plotted properly in Fig. 17. For the sake of convenience, however, all bicarbonates have been lumped in the NaHCO₃ corner. The upward movement towards the springs, therefore, is caused chiefly by the precipitation of alkaline earth carbonates during underground transport. This problem does not apply to spring and lake brines, which have very low levels of Ca and Mg.

set of data from Baker (1958) are plotted. It is even more apparent now that the decrease in bicarbonate is accompanied by an increase in NaCl. Considerable scatter exists, but a rather remarkable geographic consistency emerges concerning the west and south arm of the lake as seen in Figure 19, which shows the location (Fig. 19a) and the bicarbonate quotient against the NaCl ratio (Fig. 19b). Apparently, the contamination with bicarbonate-poor, chloride-rich brines originates from the south end of the lake, and gradually and regularly diminishes towards the northwest corner. B 15 and B 16 are the most heavily contaminated springs, and B 5 is the least contaminated one. The intermediate springs follow in a sequence exactly matching their geographic occurrence. The temperatures, too, follow fairly regularly, but the temperature differential is only 12.5°C (from 35.5 to 48°) and probably not quite reliable enough to calculate contamination ratios. Two springs have been left out of the sequence: B 9 and B 17 (see Fig. 3). They occur between B 16 and B 8. Both are much more dilute and obviously don't belong to the simple hydrological system depicted in Figure 19.

The geographic distribution of the contamination speaks for the influx of surface brines, rather than of deep-seated brines from near the center of the trough. The south end of the lake is a broad, shallow, alluvial valley, containing a large lagoon. According to the stratigraphic relationships (Eugster, 1969), it is not underlain by evaporites but by the lower sequence of the Pleistocene High Magadi Beds. This is a very obvious place for lagoon brines to enter the sub-surface circulation pattern. As suggested by the contami-

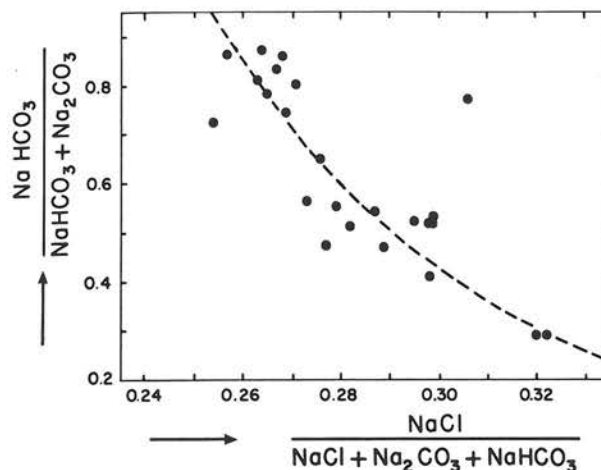

FIG. 18. Bicarbonate quotient

$$\left(\frac{\text{NaHCO}_3}{\text{NaHCO}_3 + \text{Na}_2\text{CO}_3} \right)$$

versus sodium chloride quotient

$$\left(\frac{\text{NaCl}}{\text{NaCl} + \text{NaHCO}_3 + \text{Na}_2\text{CO}_3} \right)$$

for the hot springs (Baker, 1958, data only).

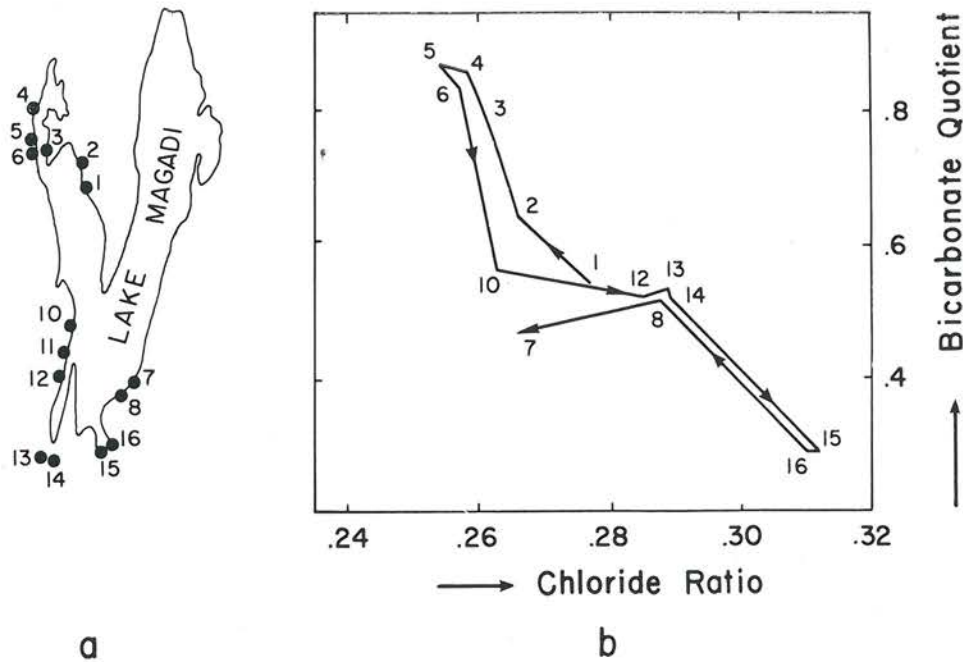

FIG. 19. Hot springs of the south and west arm, Lake Magadi. Fig. 19a gives Baker's (1958) numbers and 19b the bicarbonate quotient versus the chloride quotient. Contamination (low bicarbonate) is greatest in the south and diminishes gradually and regularly towards the north. Two springs (B9 and B17) have been omitted and obviously do not belong to this hydrological system.

nation pattern (Fig. 19), they are following an impermeable horizon towards the north.

The increase in NaCl with increasing contamination is also an important aspect of the model: this enrichment is of course due to crystallization of trona (see Figs. 16 and 17). While the shift from bicarbonate to carbonate in the springs could perhaps be explained by some underground loss of CO_2 in some unknown way, it seems very difficult to visualize a mechanism for relative NaCl enrichment without using surface processes.

Contamination of the spring waters with lagoon brines, then, is the third element in our flow sheet, and it has been indicated in Figure 6 as path III. This path represents recirculation of saline material which had previously already belonged to the spring-lagoon-lake system.

To evaluate mixing ratios, the bicarbonate quotient has been plotted against water content (or inversely, total solids) in Figure 20. Figure 20a gives the spring numbers and 20b their temperature in $^{\circ}\text{C}$. Also plotted is the most dilute lagoon water from Baker (1958), II, from the Factory Scarp Lagoon. It is obvious that the B 15–B 16 springs can form only by mixing of either average groundwater (GR) with relatively dilute lagoon water (L) of 97 percent H_2O , or of river water (R) with dilute lagoon water (96% H_2O). The slightly elevated temperature of 40°C speaks for the former. The mixing ratio is 27 percent GR + 73 percent L. On the other hand, the less contaminated springs B 4, 5, and 6 must have a more dilute input. They could be made by mixing 70 percent GR with 30 percent river water. The more dilute springs, like B 9 and B 17, and including

the other east-shore springs B 22, B 23, and B 24, need have no ground-water component but may simply be mixtures of lagoon waters with river waters, with the river waters providing the necessary hydrostatic head. The surprisingly consistent correlation with temperature (Fig. 20b) supports this conclusion. Springs on the L-R axis are coolest and temperatures increase radially towards the GR corner. The least known, and perhaps least constant point is L. Lagoon waters will have to be studied more extensively to arrive at definite conclusions. Considering the other five lagoon water analyses given by Baker (1958), it seems rather surprising that the contaminating lagoon water should be so dilute. Nevertheless, the proposed model, which is most certainly an over-simplification, fits the observation material surprisingly well.

In summary, the model for the evolution of the hot springs is based on three elements: (1) a deep-seated, stable, saline, hot groundwater reservoir, (2) dilute inflow waters similar to the Mau and Loita Hills rivers, and (3) relatively saline, carbonate-chloride-rich surface brines. The composition and temperature of a particular spring is the result of a specific mixing ratio between these three water sources. The rivers are providing the hydrostatic head necessary for spring flow, and they also act as the eventual recharge for the groundwater reservoir. Deep circulation creates a hot and concentrated spring fed directly from the reservoir. Shallow circulation, through mixing with river waters, leads to a cooler and more dilute spring if surface brines have no access. A cool and concentrated spring results from shallow circulation by mixing

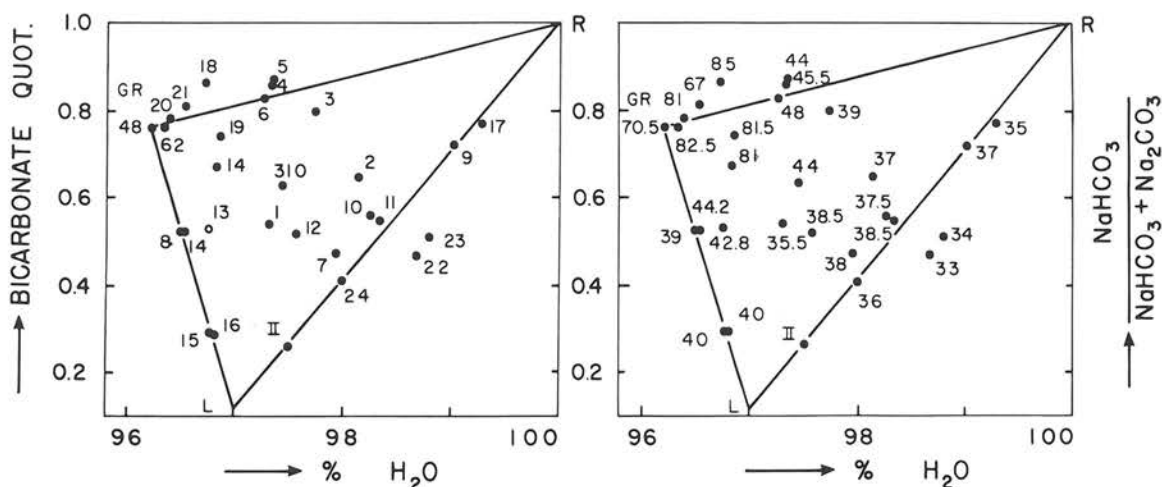

FIG. 20. Bicarbonate quotient versus water content for Magadi hot springs. Left: Baker's numbers; right: Temperatures, °C, GR: hot ground water reservoir, R: river waters, L: postulated lagoon brine, II: lagoon brine II from Baker (1958). The slight discrepancy with respect to concentration between Figs. 3c and 20 is caused by the fact that mixing ratios of 3c are based on chloride, while 20 reflects total solids.

with surface brines. The dilute and cool springs have no contribution from the deeper groundwater reservoir and represent a mixture of river waters with surface brines. In this manner, the apparent lack of correlation between temperature, concentration and discharge may be the very key for deciphering the hydrologic paths responsible for individual springs.

From the viewpoint of structural geology it seems significant that the hottest Magadi springs all appear at the western scarp where faulting must have occurred fairly recently (Eugster, 1969). Guest and Stevens (1951) also note that the hottest Natron springs are located on the west shore of the lake.

CRYSTALLIZATION IN THE SATURATED BRINES

Crystallization of trona from $\text{NaHCO}_3\text{-Na}_2\text{CO}_3\text{-NaCl-H}_2\text{O}$ brines is quite complex as is evident from the trends exhibited in Figures 16 and 17. As Bradley and Eugster (1969) have pointed out, the solubility of trona is greatly dependent upon P_{CO_2} or the bicarbonate quotient, with trona being least soluble in bicarbonate-rich brines. Data presented here show that lagoon waters seem to equilibrate with the atmosphere before saturation sets in. Therefore, when the brines reach saturation, carbonate already predominates over bicarbonate, and the precipitation of trona which removes HCO_3^- and CO_3^{2-} in equal molar ratios causes rapid depletion of HCO_3^- , thereby increasing the solubility of trona. Apparently the diffusion of CO_2 into the brine from the atmosphere is slower than evaporation, and hence the majority of the concentrated brines are nearly free of bicarbonate. Further precipitation of trona from such brines is only feasible through CO_2 supplied from outside, either from atmospheric or biogenic sources. The brines lie on the trona + thermonatrite + solution boundary (see Bradley and Eugster, 1969), and in fact thermonatrite

($\text{Na}_2\text{CO}_3 \cdot \text{H}_2\text{O}$) has been observed to crystallize in small amounts in surface pools in the lake. Judging from the mineralogy of the main body of the deposit, this thermonatrite will slowly be converted to trona through CO_2 addition. On the other hand, if the bicarbonate-free brine is removed from the lake and is left to evaporate rapidly, thermonatrite is the main precipitate. This process was discovered at Magadi and is still used commercially to produce NaCl -rich brines.

The details of the $\text{CO}_2\text{-H}_2\text{O}$ equilibria in the brines and of the exchange with the atmosphere are not yet clear. A complicating factor is the yearly production of bicarbonate-rich surface brines by dissolution of trona in dilute runoff waters during the rainy season. Halite apparently reaches saturation only under unusual conditions. This is also clearly evident from the Magadi diagram presented by Hardie and Eugster (1970).

ACCUMULATION RATES OF TRONA

We are now in a position to estimate the time elapsed since the onset of the evaporite formation. In the four drill holes described by Baker (1958), the trona accumulation is anywhere from 7- to 40-m thick. Using an average of 20 m, a lake area of 75 km^2 and a density of 2, we get a total of 3×10^9 tons of Na_2CO_3 for the whole basin. Considering all the marginal areas, interstitial brines etc., this is probably a lower limit estimate. Stevens (in Baker, 1958) estimated total daily input for each lagoon by measuring lagoon area and evaporation rate and by assuming a balance between input and evaporation during the dry season. He arrived at 4300 tons Na_2CO_3 per day for the whole basin, or about 1.5×10^6 tons/year. As we have seen from Figure 20, the bulk of this input is recirculated. For instance, the southwestern lagoon, which accounts for 37 percent of the total input, contains the most powerful springs (B 15 and

B 16), which recirculate 73 percent of their solutes and only contribute the remaining 27 percent as new to the basin. If we choose an average ratio for new to recirculated material of 1:3 for the whole basin, then the yearly input of solids new to the basin is 0.5×10^6 tons/year. In this case, assuming a constant supply rate, the deposit took $(3 \times 10^9)/(0.5 \times 10^6) = 6000$ years to accumulate. However, it is not likely that the rate of supply has remained constant but increased with time. The acceleration is difficult to estimate, but if we double the time period to 12,000 years, we are in excellent agreement with estimates based on C^{14} dates (Eugster, 1969) and also with trona accumulation rates derived for the Green River Basin (Bradley and Eugster, 1969). Langbein (1961) has pointed out that salt lakes with greatly fluctuating lake levels lose a portion of their solute load during each contraction cycle. This mechanism could also be invoked to extend the time period, although the Magadi level does not fluctuate much.

Accordingly, about 10,000 years is probably the best estimate for the time period of trona accumulation. The yearly net accumulation would be about 0.3 cm. At the present rate, the trona surface would reach the High Magadi stage in about 4500 years. However, the Magadi Soda Company is removing about 25 percent of the yearly input of new Na_2CO_3 .

The trona is banded on a 2–5 cm scale with what appears to be yearly increments (Baker, 1958). It is now clear that as much as 90 percent of a yearly band represents trona which had already resided in the basin, 2/3 of it derived from the spring-lagoon recirculation path and 1/3 presumably surface trona redissolved by dilute runoff.

We can also estimate the total input of river water required for the basin. The spring input estimate by Stevens is 260,000 m^3/day . Only 1/3 of this contains new solutes so that a daily input of 85,000 m^3/day suffices. Using a concentration factor of 1:1,000 from rivers to springs, we get 85,000,000 m^3/day river water draining into the Magadi basin. Because of the vast differences in flow between dry and rainy seasons, it is impossible at this time to check this figure directly.

OLDOINYO LENGAI: THE ULTIMATE SOURCE FOR TRONA?

Oldoinyo Lengai, an active volcano, lies just south of Lake Natron and about 100 km south of Lake Magadi. It has become of great interest to petrologists because of the presence of sodium carbonate lava, interpreted by some (for instance, Dawson, 1962) as the end product of a carbonatite-type differentiation, and by others (Milton, 1968) as trona remobilized and mixed with the alkaline lavas of the volcano. Whatever the correct interpretation, we must consider the possibility that some of the Magadi trona may ultimately have derived from Lengai eruptions.

Direct surface leaching of the lavas can be eliminated, because of the hydrologic separation between the Natron and Magadi basins. This leaves wind-borne ash as a major possible contribution. Indeed, ash collected at Magadi from

the 1967 eruption contains some new sodium-calcium silicates. Leaching of this ash, as well as ash containing nyerite and tanzanyite (see Milton 1968) would contribute sodium carbonates to the Magadi basin. Most of this volcanic contribution would probably wind up in the groundwater reservoir where it cannot be separated from the river supply. In our model, however, we need not assume any Lengai contributions to account both for the composition of Lake Magadi and for the time period available for the accumulation of all the trona present in the basin. Our model is based solely on the river compositions of today, and the accumulation rates are rather too high than too low. Also, if Lengai had contributed much Na_2CO_3 in the past, we would expect Natron to be the trona-rich lake and not Magadi.

If we postulate a deep, saline groundwater reservoir for the Magadi basin, and it is an essential feature of the model, then it is logical to assume that a similar reservoir exists from which the Natron springs are fed. The sodium-carbonate lavas of Lengai then become not so much remobilized trona, but simply the product of the interaction between the alkaline lavas and this groundwater reservoir. This interpretation eliminates the problem that the Natron basin does not seem to contain thick trona beds of the type found at Magadi. The depth of this reservoir is hard to estimate, but Guest and Stevens (1951) have suggested 1000 m below the surface of Lake Natron, based on average heat flow. If this estimate is correct, then the hottest Magadi springs would be fed from about 2500 m depth. The heat flow is most certainly higher in the Magadi area than the values on which these estimates are based, so that the groundwater reservoirs may be located at considerably shallower levels.

THE NATRON BASIN: A COMPARISON

Guest and Stevens (1951) have given a detailed account of the compositions of Lake Natron springs and brines. The report is not readily available, and their data are therefore included here. Figure 21 gives the sampling locations and Table 4 the compositions. Numbers 9 through 10 are springs, 14 through 41 are surface brines, 18 is the Uaso Nyiro at Melil Hill, where it enters Lake Natron, and 39 is the Peninj River. All samples were taken in 1950. Guest and Stevens arrived at the following conclusions with respect to spring compositions:

“1. The NaCl content of the total solutes increases slightly from the SE to the NE, remains high in the NW with peak values around 40% from the Losideti lagoon to a small spring 3 miles south, then falls abruptly from around 30% to less than half that figure at a point near the south end of the West Lagoon.

2. The sulphate proportion is lowest in the NE and NW, rises slightly in the E and SE, but on the west it rises steadily south of the Humbu and then jumps to around 30% at the point near the south end of the West Lagoon where the NaCl content falls so suddenly.

A study of the analyses of the spring waters at the south-west side of Lake Natron gives the impression that there is a high-level body of dilute ground water to the southwest of the lake

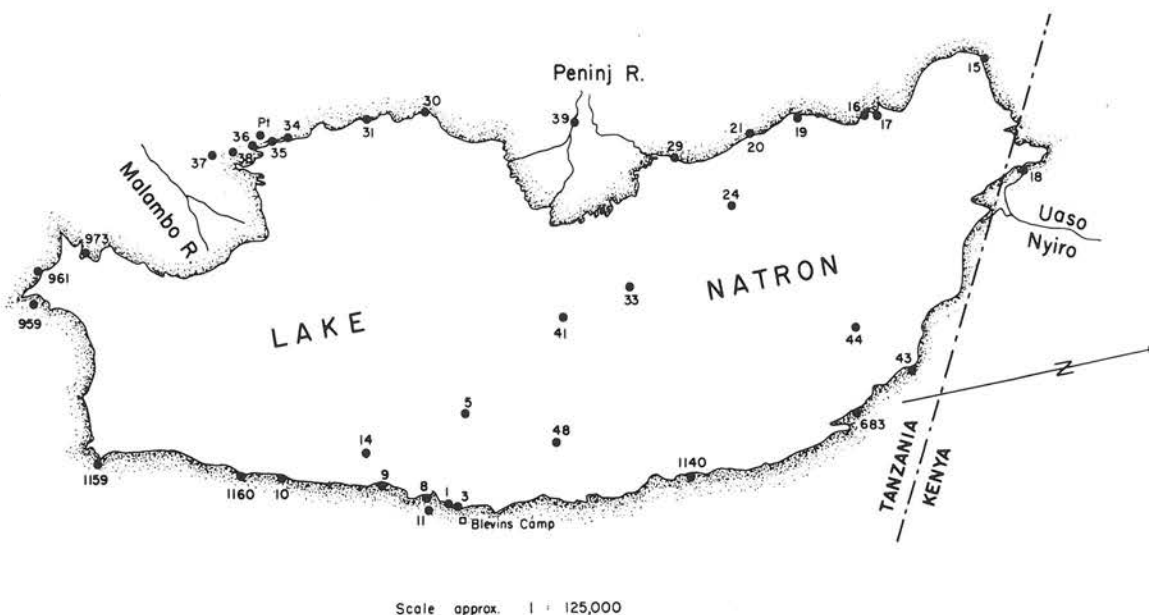

FIG. 21. Sampling stations for Lake Natron (simplified from Guest and Stevens, 1951). The numbers are identified in Table 4.

whose average composition is typified by samples Nos. S36, S38, JG973, and JG961. This ground water has a much higher proportion of sulphate and lower proportion of chloride and carbonate than a lower-level body of more concentrated ground water further north, and further east . . . The high temperatures of some of the springs may be an indication of very deep-seated channels. . . Therefore, the group of warmest springs, some over 50 degrees C. on the western side of the lake, would appear to originate from the deepest source. . .” (Guest and Stevens, 1951, p. 7).

Guest and Stevens (1951) also pointed to the constancy of spring temperatures and compositions and reported three analyses of the same spring, carried out over a 20-year period (see Table 5).

Figure 22 gives the sodium versus chloride data. The Na/Cl ratio does not exhibit the constancy so typical for the Magadi hot springs. As Guest and Stevens (1951) pointed out, the chloride-rich springs occur in the NW and emerge at the foot of Oldoinyo Sambu, while the chloride-poor inflow comes from the more dilute waters of the SW. The NE springs are on the Magadi trend, while those of the E shore are slightly poorer in chloride. The brines again show the familiar enrichment in Cl.

As Figures 23, 24, and 25 demonstrate, these regional differences are not expressed in total carbonate, but they are very strongly visible in the sulfate values, and less so in fluoride. According to Figure 23, $\sum \text{CO}_3/\text{Na}$ is remarkably constant if somewhat lower than at Magadi. Unfortunately, no bicarbonate determinations were carried out so that we are unable to check for contamination with surface brines.

The large scatter in the SO_4/Cl values (see Fig. 24) is a direct expression of the regional differences. The SO_4/Cl

ratios are lowest in the NW (chloride-rich springs) and gradually increase towards the south. Only the NW springs are close to the Magadi trend, while all others, including the E springs, are considerably richer in sulfate. The dilute inflow of the SW is richest in sulfate. The surface brines still reflect some of the regional differences though there must be considerable mixing.

Fluoride versus chloride (Fig. 25) shows similar relationships but they are less pronounced. Again, Natron is in general higher in fluoride than Magadi.

From this preliminary analysis it is obvious that the hydrology of Lake Natron is considerably more complex than that of Lake Magadi. Perhaps as much as three separate reservoirs exist from which different spring groups are fed. NW springs are high in Cl, low in SO_4 and F; the SW inflow is low in Cl and very high in SO_4 and F; the springs from the E and W shore occupy an intermediate position.

Figure 26 underscores these regional differences. All springs, except those of the SW corner, can be obtained by mixing E springs (GS 8) with NW springs (GS 16). In fact, the regional distribution of the spring compositions is quite symmetrical with respect to an axis from GS 8 to GS 16. This is true for springs as far south as GS 30 on the west shore and GS 1159 on the east shore. Further south, however, the influence of the sulfate waters GS 973 and GS 36, make themselves felt very strongly, forming a diverging trend. It is interesting to note that the two waters from the foot of Oldoinyo Lengai (GS 959 and 961) are higher in carbonate, though they too carry much sulfate.

The surface brines are also plotted in Figure 26, and they indicate that the inflow differences have not yet been eliminated. The regional distribution is again quite regular, and

TABLE 4. COMPOSITION OF LAKE NATRON HOT SPRINGS (S), BRINES (B) AND RIVERS (R)^a

#	T(°C)	SiO ₂	Na	K	CO ₃	SO ₄	Cl	F	Dissolved solids	Density	Key
9	40.5	67	2,950	53	2,700	118	1,190	35	7,113	1.0049	R
8	46	68	15,570	318	14,680	699	5,710	234	37,279	1.0331	S
11	38.5	74	2,600	—	2,390	100	1,060	31	6,255	1.0015	S
1	41	—	8,860	147	8,300	398	3,310	133	21,148	1.0180	S
1140	38	—	19,600	—	18,240	787	7,540	316	46,483	1.0433	S
44	38	—	12,250	—	10,810	276	5,650	145	29,131	1.0263	S
683	—	—	12,500	—	10,990	281	5,770	148	29,689	1.0266	S
43	39	—	10,700	—	9,310	241	5,080	115	25,446	1.0225	S
15	34.5	—	18,200	202	16,000	204	8,600	235	43,441	1.0365	S
17	38.5	390	27,200	360	21,820	526	15,100	323	65,719	1.0537	S
16	34	—	6,220	—	4,630	182	3,860	68	14,960	1.0107	S
19	35.5	—	7,740	111	6,370	175	4,110	92	18,598	1.0117	S
20	41.5	—	5,100	—	4,460	131	2,400	55	12,146	1.0064	S
21	42	—	3,400	—	3,040	109	1,495	37	8,081	1.0030	S
29	45	—	7,130	—	6,290	149	3,330	77	16,976	1.0126	S
30	48	—	5,900	90	5,290	227	2,530	70	14,107	1.0105	S
31	50	—	6,480	—	5,700	335	2,870	70	15,455	1.0133	S
34	37	—	2,280	—	1,990	158	980	30	5,438	1.0048	S
35	33	—	1,280	—	1,120	114	538	18	3,070	1.0016	S
Pt	33.5	—	1,480	—	1,240	195	598	—	3,513	1.0032	S
36	32.5	—	356	—	286	167	71	9	889	1.0000	R
38	32	—	338	—	281	147	66	8	840	0.9960	R
37	33	30	979	—	868	113	375	14	2,349	0.9980	R
973	—	—	270	—	211	136	58	4	679	0.9990	R
961	—	—	800	—	686	365	127	14	1,992	1.0008	R
959	30.5	—	1,480	—	1,350	345	359	39	3,573	1.0023	S
1159	35.5	—	1,830	—	1,680	71	785	18	4,357	1.0032	S
1160	38	—	2,300	54	2,120	104	922	25	5,525	1.0043	S
10	46	—	9,210	220	8,640	428	3,420	138	22,056	1.0181	S
14	—	—	138,100	—	99,070	3,720	90,670	1,312	332,872	1.315	B
3	—	—	100,600	—	95,650	5,275	48,520	1,312	251,357	1.208	B
5	—	—	137,100	—	117,470	5,000	66,100	1,493	327,163	1.312	B
48	—	—	136,800	—	113,500	4,260	70,960	1,402	326,922	1.318	B
24	—	—	136,000	—	92,840	3,380	95,220	1,221	328,661	1.312	B
33	—	—	134,900	—	89,440	3,040	97,650	1,312	326,342	1.306	B
41	—	—	136,500	—	93,970	3,100	94,600	1,357	329,527	1.309	B
18	—	—	84.7	—	68	15	36	1.8	205.5	1.000	R
39	—	—	6.4	—	3.4	—	—	3.2	13.0	1.000	R

Recalculated from Guest and Stevens (1951). For locations see Fig. 21.

the brine compositions are a function of their location with respect to the G 8-G 16 axis. Further NaCl enrichment is noticeable in some brines, presumably caused by trona precipitation. GS 16 may be GS 8 contaminated with surface brines, but carbonate-bicarbonate data are needed to check this point. No SW brines were sampled by Guest and

Stevens (1951), so that the effect of the high sulfate inflow on the lake as a whole cannot be evaluated.

The causes of the regional differences in the spring compositions remain to be discovered.

CONCLUSIONS

The model we have developed for Lake Magadi, and by implication also for Lake Natron, is based on an evolutionary link between inflow waters and hot springs. To explain the compositions of individual springs, we assumed mixing from three sources: shallow inflow, a deep groundwater reservoir, and surface brines. During the underground travel from inflow to groundwater reservoir, all of the alkaline earths are lost, and most of the water, silica, potash and total carbonate. Conserved are sodium, fluoride, chloride, bromide, sulfate and boron. This is compatible with what we know of mineral-water interactions. Ac-

TABLE 5. ANALYSES OF GELAI MAGNESITE MINE SPRING #1,^a IN G/100G

Date	Total Solids	Na ₂ CO ₃	NaCl	Na ₂ SO ₄	NaF	Density
1/ 5/1930	2.130	1.460	0.542	n.d.	n.d.	1.020
2/13/1941	2.070	1.45	0.54	0.060	0.026	1.016
10/13/1950	2.101	1.450	0.540	0.058	0.029	1.018

^a Guest and Stevens, 1951.

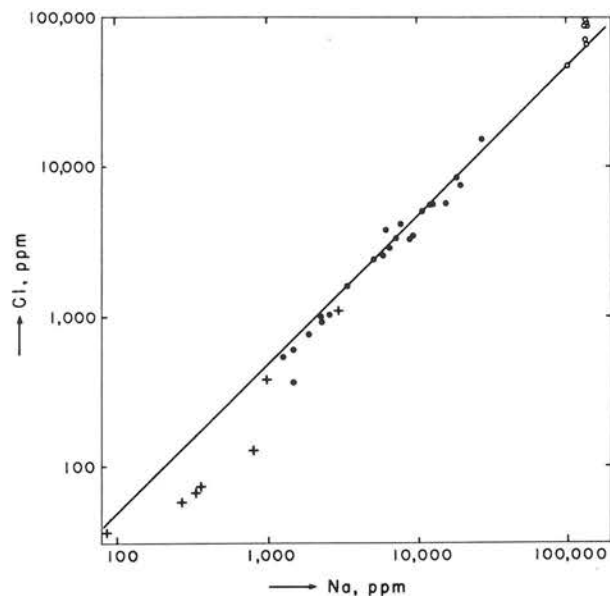

FIG. 22. Chloride versus sodium for Lake Natron waters. Solid line is the Magadi trend, from Fig. 4. Dots: brines, circles: springs, crosses: rivers.

According to the model, 99.9 percent of the water entering the Rift Valley is lost by the time the groundwater reservoir is reached. Some of this, to be sure, is due to surface evaporation. The Uaso Nyiro, for instance, can be as saline as the reservoir itself (see Table 1). But most rivers do not travel far enough along the valley floor to be concentrated to this extent. They are still relatively fresh when they disappear underground. Hence we know that a large amount of dilute water is entering the subsurface circulation system, and the only visible exit is the hot springs.

To explain these features we have assumed continuous, slow evaporation through a deep, capillary system of

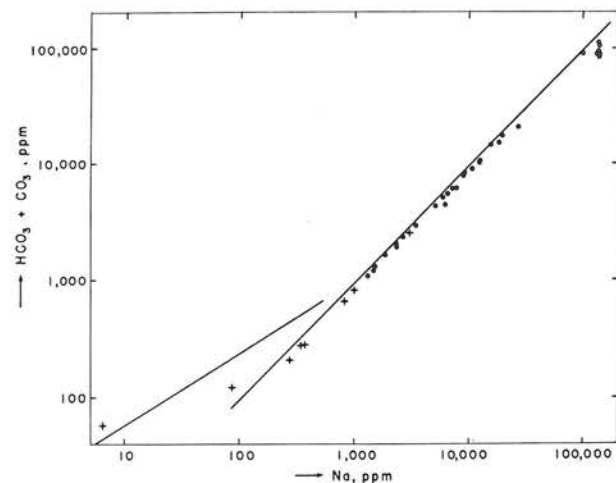

FIG. 23. Total carbonate versus sodium for Lake Natron waters. Solid line is the Magadi trend, from Fig. 7. Symbols as in Fig. 22.

fissures, joints and cracks, acting over the whole Rift Valley floor, a mechanism similar to the evaporative pumping demonstrated by Hsü and Siegenthaler (1969).

There are some alternatives to this explanation. Surface evaporation could have been more intense in the past and the groundwater reservoir could have acquired its high salinity during an earlier period. The depositional record (Eugster, 1969) seems to indicate the opposite: more inflow and less evaporation some 10,000–20,000 years ago.

We could locate the evaporation very near the surface just after the rivers disappear underground. We would then expect to find some indications near the toes of the fans such as extensive efflorescent crusts. Again, this appears not to be the case. Finally, all the evaporation could take place on the surface of Lake Magadi itself. In other words, the saline groundwater reservoir is simply the result of mixing surface brines with river waters. As we showed in Figure 17, this is not compatible with the carbonate-bicarbonate ratios since the reservoir is much richer in bicarbonate than the surface brines. One could counter, that the reservoir waters have ample time to pick up the additional CO_2 from biological sources. But a more potent argument against the simple mixing model is the distinct chloride enrichment apparent in the most fractionated brines (see Figs. 4 and 17). This enrichment is not present in the springs and hence in the reservoir. Some downward movement of surface brine must occur but it seems restricted to the lagoon waters of the south end (see Fig. 19). The circulation is probably shallow, though it is of course possible that some of this brine will eventually find its way into the reservoir where it would have to adjust its bicarbonate-carbonate ratio.

In the past, hydrologic problems involving hot springs have often been solved by assuming a juvenile origin for the springs. Isotopic evidence indicates, however, that the bulk of thermal waters is of meteoric origin. As we have seen, this conclusion also fits Magadi.

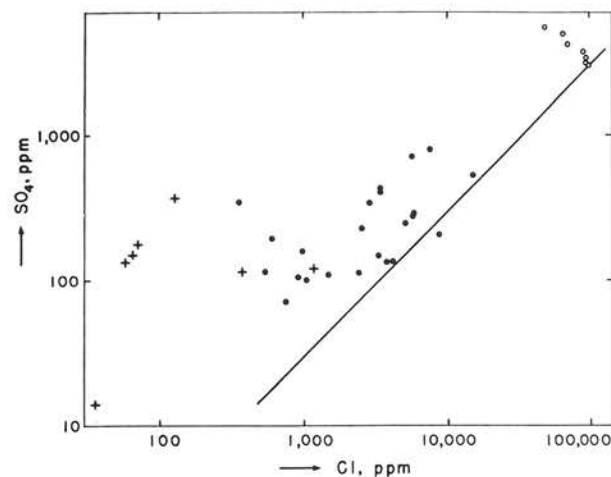

FIG. 24. Sulfate versus chloride for Lake Natron waters. Solid line is for the Magadi trend, from Fig. 10. Symbols as in Fig. 22.

We now come to the question of universality: In what sense is Magadi a model for Lake Gosiute of the Green River period and to what extent is it typical of all salt lakes? The compositional aspects of closed basin lakes have been treated elsewhere (Hardie and Eugster, 1970) so we can concentrate on hydrology and more general aspects.

Some of the hydrologic factors controlling the existence of salt lakes have been set out by Langbein (1961). Salt lakes form in tectonically active areas in arid to semi-arid climates. Downwarping or faulting is essential to initiate the closed basin. High evaporation rates are necessary to prevent it from being filled with a fresh-water lake. On first thought, the more arid a climate, the more effectively it should promote the formation of a salt lake. This is not necessarily so. Salt lakes require a very considerable input of solutes over a prolonged period of time. This means in general that perennial fresh-water streams must enter the basin. The apparent contradiction between high evaporation rates and large inflow is usually due to large vertical relief. The salt lake itself is at a low elevation in a desert-like environment, but the basin is bordered by high mountains which receive enough rainfall to produce streams. Most of the perennial streams descending into the basin disappear underground when they approach the valley floor. Their water reappears as springs on the perimeter of the salt lake. It is these springs which finally convey to the lake the solute load acquired in the water shed through weathering reactions. Particularly large perennial streams may become perched streams and travel long distances, delivering at least some of their water directly to the lake.

This greatly simplified hydrologic character is common to many closed-basin salt lakes, such as Deep Springs

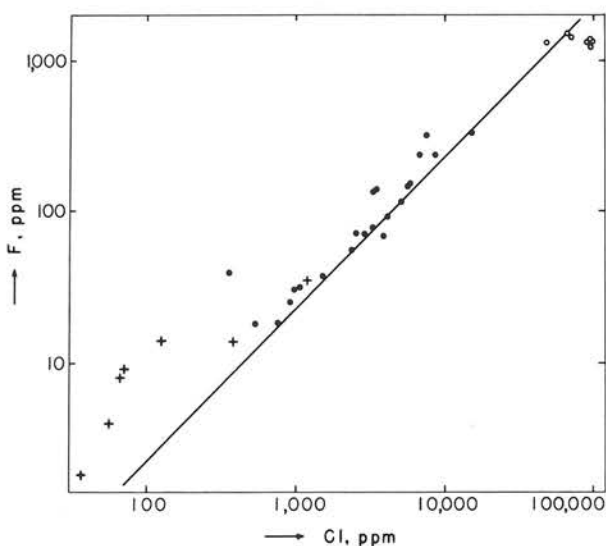

FIG. 25. Fluoride versus chloride for Lake Natron waters. Solid line is for the Magadi trend, from Fig. 9. Symbols as in Fig. 22.

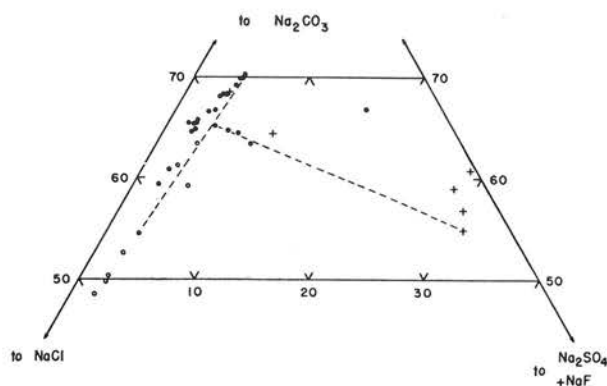

FIG. 26. Portion of the system $(\text{NaHCO}_3 + \text{Na}_2\text{CO}_3) - \text{NaCl} - (\text{Na}_2\text{SO}_4 + \text{NaF})$ for Lake Natron waters. For symbols see Fig. 22. Large regional differences among spring compositions are apparent. The dashed line in the left connects spring GS 8 (top) with GS 16 (bottom) and provides a symmetry axis (see Fig. 21 and text) with respect to location and composition. The dashed line crossing to the right connects the river GS 973 (right) with the spring GS 31 (left). The point for GS 30 lies straight above that for GS 31, and 1159 lies above and slightly to the right of GS 31. GS 36 is directly above GS 973, while GS 961 is above 36 and to the right. GS 959 is the lone spring in the upper right.

(Jones, 1965), Saline Valley (Hardie, 1968), Dead Sea (Lerman, 1967), Abert Lake (Jones and VanDenburgh, 1967), Lakes Magadi and Natron and it probably applies also to fossil ones like Green River (Bradley and Eugster, 1969) and Searles Lake (Smith, 1966). In all cases, springs issuing near the salt lake are important elements. They imply the existence of a groundwater reservoir. In some instances, this reservoir is dilute, as at Deep Springs (Hardie and Eugster, 1970), in others, as at Magadi, saline. The salinity seems to be governed by the size of the basin, depth of circulation and total inflow, as well as evaporation rates. Deep Springs is a small basin, receiving much inflow, and it probably has a shallow and rapid circulation. Its springs, therefore, are cool and little more concentrated than the streams. Magadi, on the other hand, is based on a vast evaporation area, deep and probably slow circulation and comparatively less inflow. Its springs and groundwater are hot and concentrated. Saline Valley occupies an intermediate position¹. Lake Natron, the Dead Sea and Abert Lake are at an earlier stage of evolution where the lakes are saline, but they have not yet precipitated large amounts of saline minerals. All of them are reached, or nearly reached, by large perennial rivers. Searles Lake is at the other end of the spectrum because it has ceased to be a growing salt lake and its springs have dried up.

Seen in this context, the ground water reservoirs of Magadi and Natron are the norm rather than the exception. Admittedly, temperature and salinity of the springs are higher than usual, but they can be explained. In fact,

¹ In the sense that the concentration factor rivers:springs is 2-3 for Deep Springs (Hardie and Eugster, 1970), around 10 for Saline Valley (Hardie, 1968, p. 1288), and 1000 for Magadi.

every salt lake of the Eastern Rift Valley (see Fig. 1) is fed by hot, saline springs. Perhaps unique at Magadi is the apparently uniform permeability distribution responsible for the well mixed reservoir.

If our inferences are correct, Lake Magadi is a good model for Lake Gosiute in its general hydrologic character. At the salting stage, Lake Gosiute too may have been fed primarily by springs (for hot-spring evidence see Bradley and Eugster, 1969) though their salinity is unknown. The main differences, on the other hand, are related to the size and stability of the basins. Magadi is much smaller, and it probably has subsided much more rapidly. It contains a single trona bed of some 20–40 m thickness in contrast to the numerous, but thinner trona beds of the Green River formation. This must be related to the differences in their tectonic environments. Both areas were volcanically active, but Lake Gosiute was presumably a much more permanent feature.

We are now also in a position to evaluate the differences between some of the individual closed basins occupying the Eastern Rift Valley. As has been pointed out, Magadi occupies the lowest point in the valley. More significant, however, is the fact that it is the only lake over a stretch of some 100 km in an area which receives large amounts of inflow from the mountains bordering it (see Fig. 2). With the vast catchment and evaporation areas involved, Lake Magadi should be expected to be very saline. The thick trona accumulation implies a very deep initial trough, or continuing subsidence. Some independent support exists for the latter (Eugster, 1969). Lake Natron, on the other hand, is much larger and shallower, and has much smaller catchment and evaporation areas. However, its ground-

water reservoir is also quite saline but, as we have seen, it is not well mixed. From the absence of thick trona accumulations, we may conclude that the reservoir has become saline more recently than that of Magadi. Lake Naivasha is anomalously dilute. It is in an area of high inflow but evaporation rates are much lower because of the higher altitude. It is also possible that Naivasha loses substantial amounts of water underground to the Magadi system. The remaining lakes are less well known with respect to their hydrology and hydrochemistry.

I am convinced that work at Lake Magadi has provided us with a model of general validity for the circulatory systems of closed basin lakes. Magadi itself is at the stage of maximum productivity with respect to saline minerals and as such is a most important link in the evolutionary chain of salt lakes.

ACKNOWLEDGEMENTS

Field work on which this report is based was made possible through grants from the Petroleum Research Fund (PRF No. 2093-C) and the National Science Foundation (NSF No. GA 1507). The Magadi Soda Company and its officers were generous hosts during the sampling in 1966 and 1968. J. R. Wood helped collect and measure some of the waters in 1968. The bulk of the analytical work was carried out by Shirley L. Rettig, in consultation with Dr. B. F. Jones of the U. S. Geological Survey, and this study owes much to their gracious cooperation. The paper was written while I was a guest at the Institut für Kristallographie und Petrographie der ETH, Zürich, and I am indebted to Prof. F. Laves for his hospitality. An earlier version was presented at the Bat-Sheva Seminar in Rehovot in 1969, and I thank Drs. J. Gat and A. Lerman for that opportunity. The manuscript was improved substantially through reviews by L. A. Hardie and B. F. Jones.

REFERENCES

- BAKER, B. H. (1958) Geology of the Magadi area. *Geol. Surv. Kenya, Rept.* **42**, 81 p.
- (1963) Geology of the area south of Magadi. *Geol. Surv. Kenya, Rept.* **61**, 27 p.
- BRADLEY, W. H., AND H. P. EUGSTER (1969) Geochemistry and paleolimnology of the trona deposits and associated authigenic minerals of the Green River Formation of Wyoming. *U. S. Geol. Surv. Prof. Pap.* **496B**.
- DAWSON, J. B. (1962) The geology of Oldoinyo Lengai. *Bull. Volcan.* **24**, 349–387.
- ELLIS, A. J., AND W. A. J. MAHON (1964) Natural hydrothermal systems and experimental hot-water rock interactions. *Geochim. Cosmochim. Acta* **28**, 1323–1357.
- EUGSTER, H. P. (1969) Inorganic bedded cherts from the Magadi area, Kenya. *Contr. Mineral. Petrology*. **22**, 1–31.
- , AND B. F. JONES (1968) Gels composed of sodium-aluminum silicate, Lake Magadi, Kenya. *Science* **161**, 160–164.
- FETH, J. H., C. E. ROBERSON, AND W. L. POLZER (1964) Sources of mineral constituents in water from granitic rocks, Sierra Nevada, California and Nevada. *U. S. Geol. Surv. Water Supply Pap.* **1535-I**.
- GARRELS, R. M., AND F. T. MACKENZIE (1967) Origin of the chemical composition of some springs and lakes. *In Advances in Chemistry Series, Amer. Chem. Soc.*, 222–242.
- GUEST, N. J., AND J. A. STEVENS (1951) Lake Natron, its springs, rivers, brines and visible saline reserves. *Geol. Surv. Tanganyika Mineral Resources Pamph.* **58**.
- HAINES, D. V. (1959) Geologic investigations in the Mojave desert and adjacent region, California. *U. S. Geol. Surv. Bull.* **1045-E**.
- HARDIE, L. A. (1968) The origin of the Recent non-marine evaporite deposit of Saline Valley, Inyo County, California. *Geochim. Cosmochim. Acta* **32**, 1279–1301.
- HARDIE, L. A., AND H. P. EUGSTER, (1970) The evolution of closed basin brines. *Mineral. Soc. Amer. Spec. Paper* **3**, 273–290.
- HSÜ, K. J., AND C. SIEGENTHALER (1969) Preliminary experiments on hydrodynamic movement induced by evaporation and their bearing on the dolomite problem. *Sedimentology* **12**, 11–25.
- JONES, B. F. (1965) The hydrology and mineralogy of Deep Springs Lake, Inyo County, California. *U. S. Geol. Surv. Prof. Pap.* **502A**,
- (1966) Geochemical evolution of closed basin waters in the western Great Basin. *2nd Symp. Salt, N. Ohio Geol. Soc., Cleveland*, **1**, 181–200.
- , S. L. RETTIG, AND H. P. EUGSTER (1967) Silica in alkaline brines. *Science* **158**, 1310–1314.
- , AND A. S. VANDENBURGH (1967) Geochemical influences on the chemical character of closed lakes. *I.A.S.H. Symp. Garda*, **70**, 435–446.
- LANGBEIN, W. B. (1961) Salinity and hydrology of closed lakes. *U. S. Geol. Surv. Prof. Pap.* **412**.

- LERMAN, A. (1967) Model of chemical evolution of a chloride lake—The Dead Sea. *Geochim. Cosmochim. Acta* **31**, 2309–2330.
- MILTON, C. (1968) The "Natro-Carbonatite Lava" of Oldoinyo Lengai, Tanzania (abstr.). *Prog. Geol. Soc. Amer. Ann. Meet. Mexico City, 1968*, p. 202.
- RAINWATER, F. H. AND L. L. THATCHER (1960) Methods for collection and analysis of water samples. *U. S. Geol. Surv. Water Supply Pap.* **1454**.
- SMITH, G. I. (1966) Geology of Searles Lake—A guide to prospecting for buried continental salines. *2nd Symp. Salt, N. Ohio Geol. Soc., Cleveland*, **1**, 167–180.
- STRÜBEL, G. (1965) Quantitative Untersuchungen über die hydrothermale Löslichkeit von Flussspat, (CaF₂). *Neues Jahrb. Mineral. Monatsh.* **3**, 83–95.
- (1968) Hydrothermale Lösungen. *Geol. Rundschau* **58**, 259–273.
- TALLING, J. F. AND I. B. TALLING (1965) The chemical composition of African lake waters. *Int. Rev. Gesamter Hydrobiol.* **50**, 421–463.